



Micro Metal
Corporation



SURGICAL INSTRUMENTS CATALOGUE



Table Of Contents











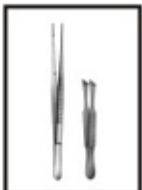
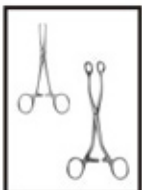
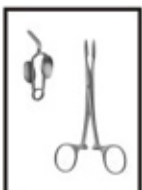
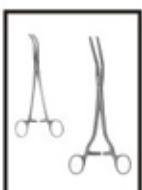

	Page Seite		Page Seite	
Diagnostic, Anaesthesia and other instruments	1 - 10		Probes, Pocket Instruments sets	66 - 68
Scalpels, knives and Scalpel Handles	11 - 14		Wound Retractors	69 - 80
Scissors	15 - 31		Self-Retaining Retractors, Abdominal Retractors	81 - 85
Dissecting-and Tissue Forceps	32 - 42		Abdominal Surgery Intestinal-and Rectal Instruments	86 - 93
Sponge, Dressing and Tissue Grasping Forceps Towel Clamps	43 - 48		Gall Bladder-, Liver-and Spleen Instruments	94 - 96
Vessel Clips, Bulldog Clamps Haemostatic Forceps	49 - 57		Genito-Urinary Instruments and Trocars	97 - 100
Ligature, Hysterectomy and Compression Forceps Vaginal Clamps	58 - 60		Vaginal Specula and Uterine Dilators	101 - 106
Needle Holders, Suture Instruments	61 - 65		Uterine Probes, Uterine Dressing-, Polypus-and Ovum Forceps	107 - 109



Table Of Contents

	Page Seite		Page Seite
Biopsy Instruments and Curettes	110 - 116		Suction Instruments 158 - 166
Obstetrics and Tracheotomy	117 - 119		
Cardiovascular-and Thoracic Surgery	120 - 128		
Bone Punches, Rongeurs	129 - 134		
Elevators, Bone Levers, Raspatories, Bone Files, Bone Curettes	135 - 139		
Mallets, Chisels and Gouges	140 - 141		
Bone Holding Forceps, Bone Rongeurs, Bone Cutting Forceps	142 - 146		
Plaster Instruments	147 - 157		

Percussion Hammers and Aesthesiometers



01-101
TROEMNER
Size: 245 mm



01-102
DEJERINE
Size: 200 mm



01-103
DEJERINE
with needle
Size: 210 mm



01-104
TAYLOR
Size: 195 mm



01-105
BERLINER
Size: 200 mm

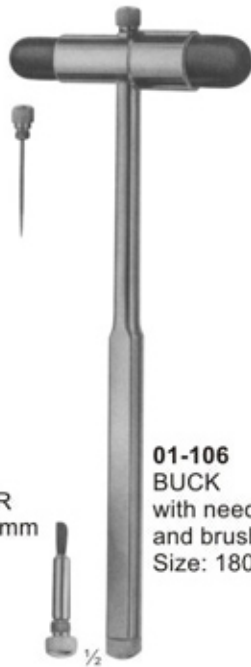

01-106
BUCK
with needle
and brush
Size: 180 mm



01-107
RABINER
with needle
and brush
Size: 255 mm



01-108
ALY
Size: 190 mm



01-109
WARTENBERG
Pinwheel for
neurological
examination
Size: 185 mm

Stethoscopes



01-110
PINARD (Aluminum)
Size: 155 mm

½



01-111
wooden
Size: 145 mm

½



01-112
BOWLES
Stethoscope
with diaphragm

¼



01-113
ANESTOPHON

½



01-114
FORD-BOWLES
Dual chest piece
with two outlets

¼



01-115
BOWLES

¼

Head Mirrors and Head Bands

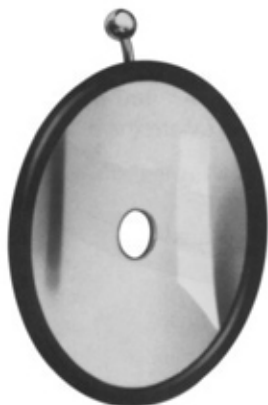

01-116
ZIEGLER Ø 90mm
head mirror only
with rubber coating

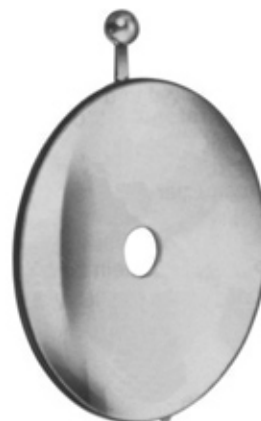

01-117
ZIEGLER Ø 90mm
head mirror only
with metal coating



01-118
ZIEGLER
head band of plastic black

01-119
ZIEGLER
head band of plastic white

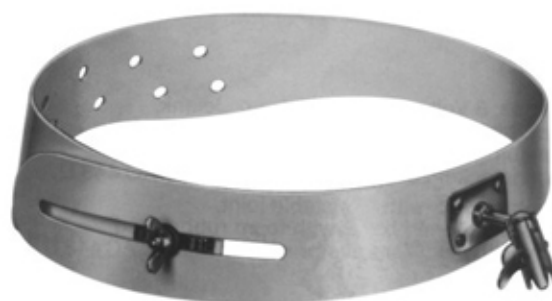

01-120
MURPHY
head band of celluloid, white

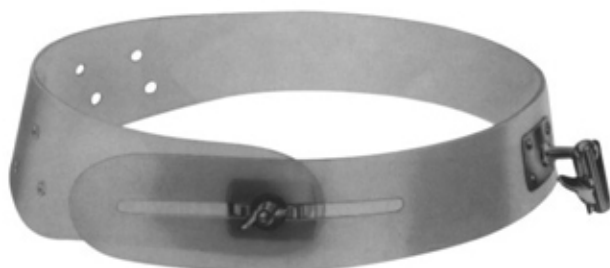

01-121
head band of plastic,
white, soft pattern



01-122
head mirror with black
plastic head band.

Tongue Depressors

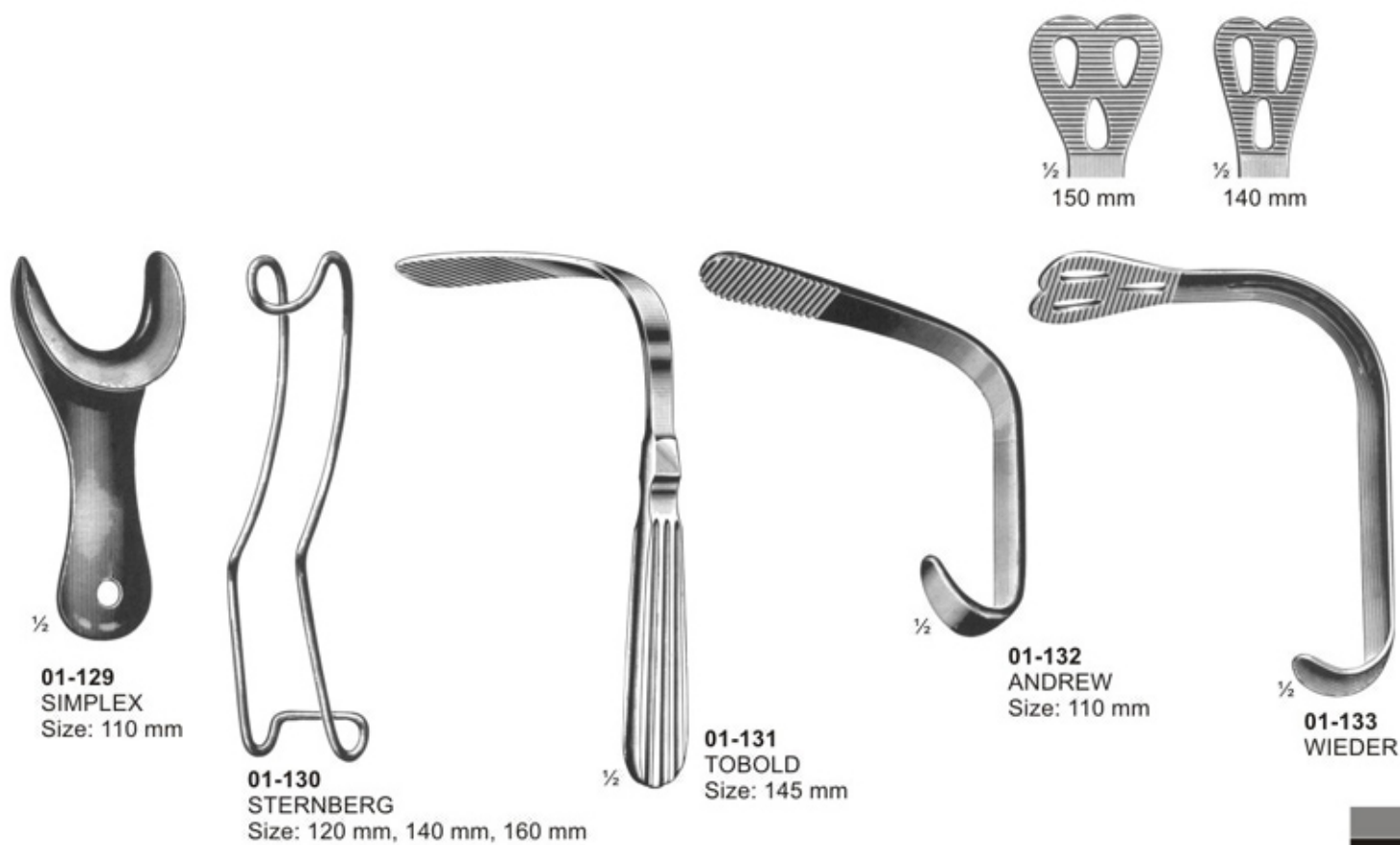
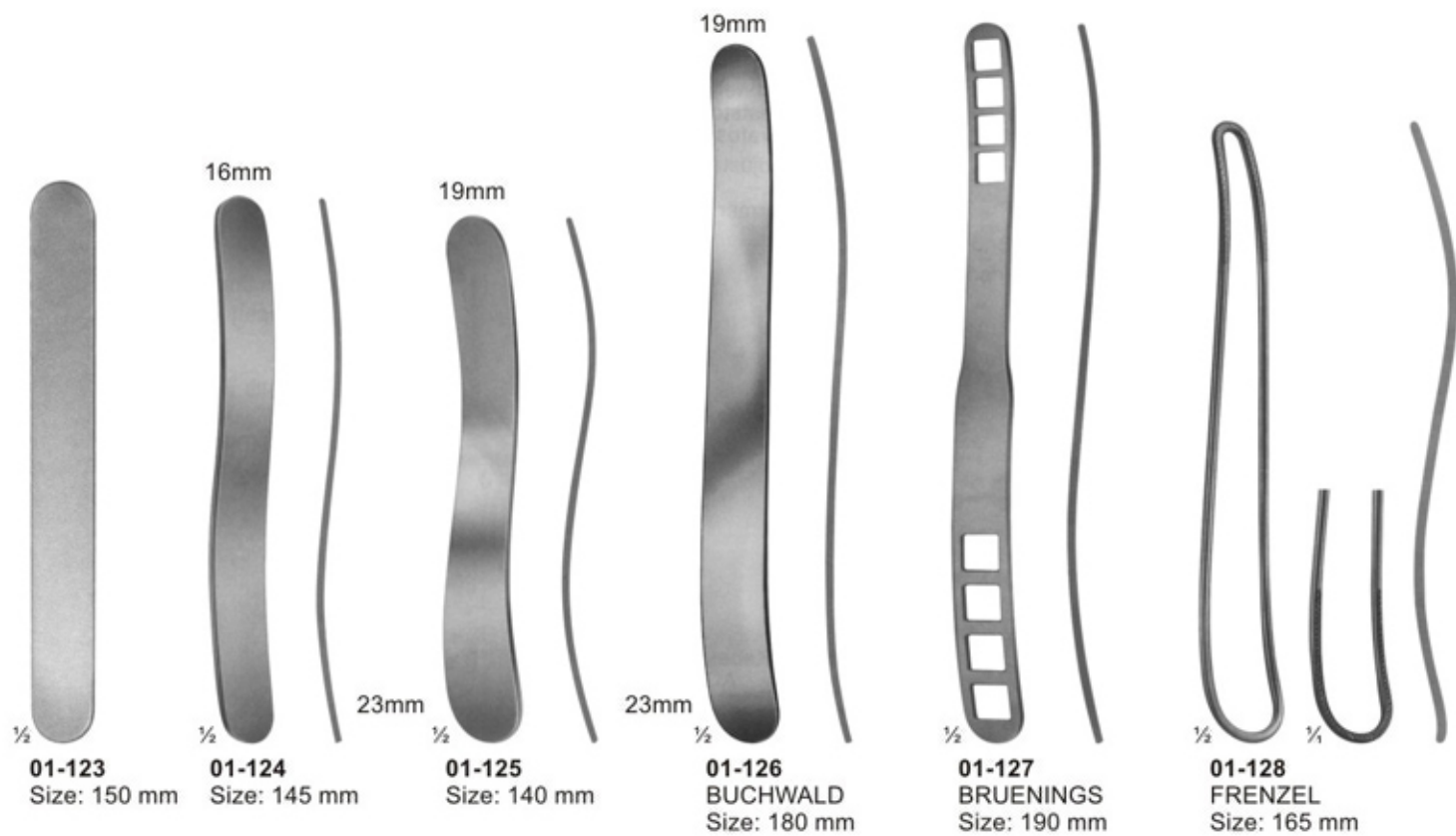

Instruments for Anaesthesia and Tongue Forceps



½

01-134
SCHIMMELBUSCH
Ether mask



½

01-135
HEISTER
Mouth gag
Size: 130 mm



½

01-136
FERGUSSON-ACKLAND
Mouth gag
Size: 145 mm



½

01-137
DENHARDT
Mouth gag with silicon
inserts, interchangeable
Size: 125 mm



½

01-138
ROSER KOENIG
Mouth gag
Size: 160 mm, 185 mm



½

01-139
YOUNG
Size: 165 mm



¼

1 Pair Of
Rubber Pads

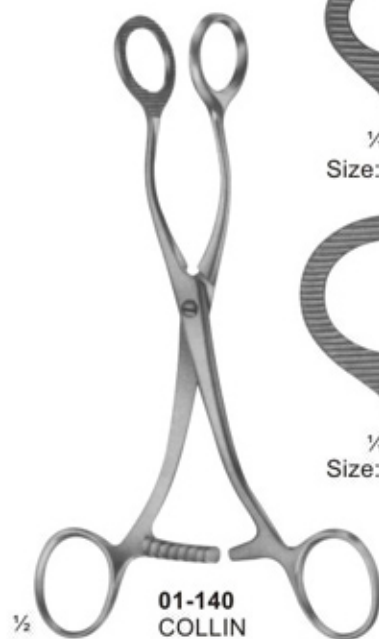

½

01-140
COLLIN
Size: 160 mm,
170 mm



¼

Size: 160 mm



¼

Size: 170 mm

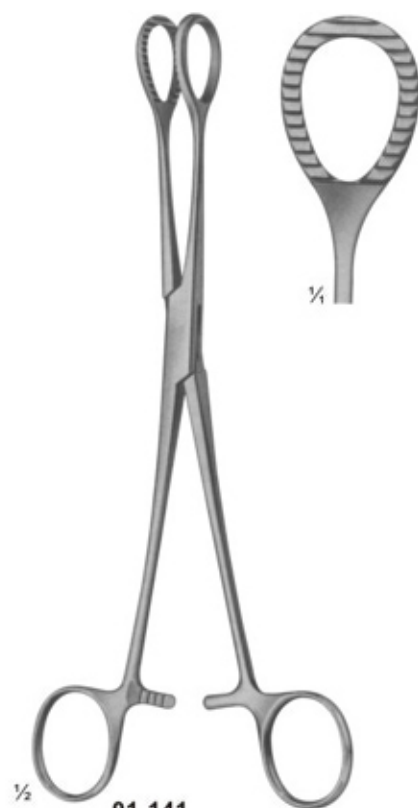

½

01-141
HEYWOOD-SMITH
modif. Size: 215 mm

Blood Lancets and Laryngeal Mirrors

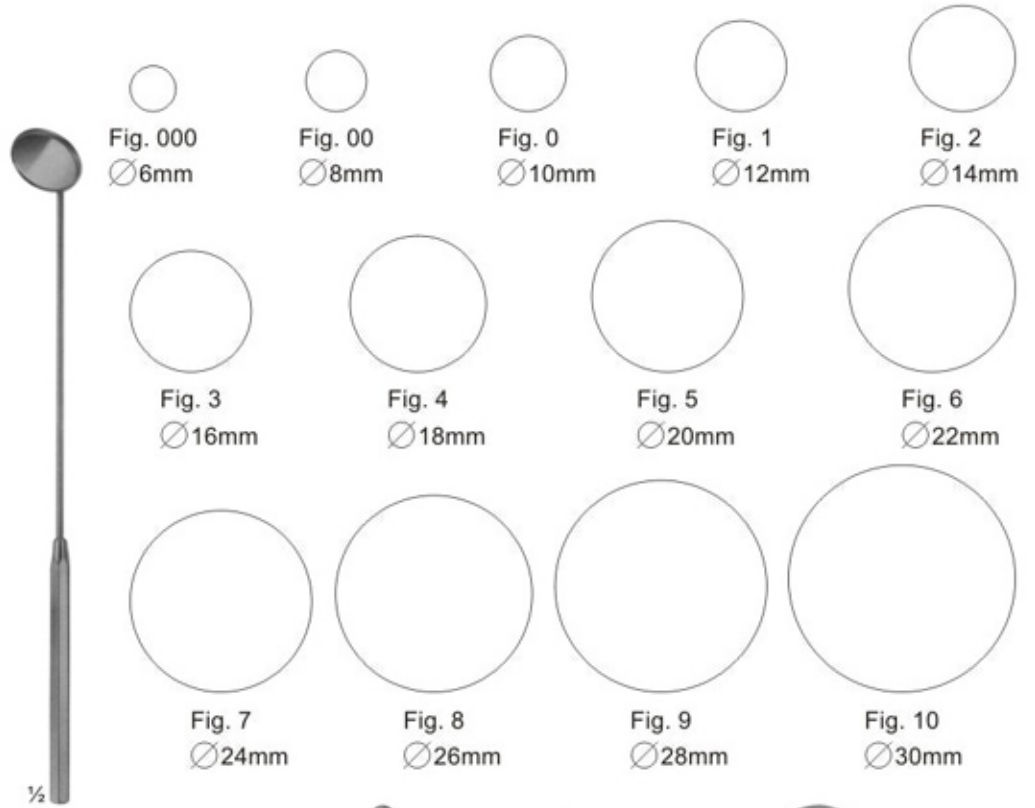

01-143
Laryngeal mirrors with
hexagonal handle
Size: 180 mm

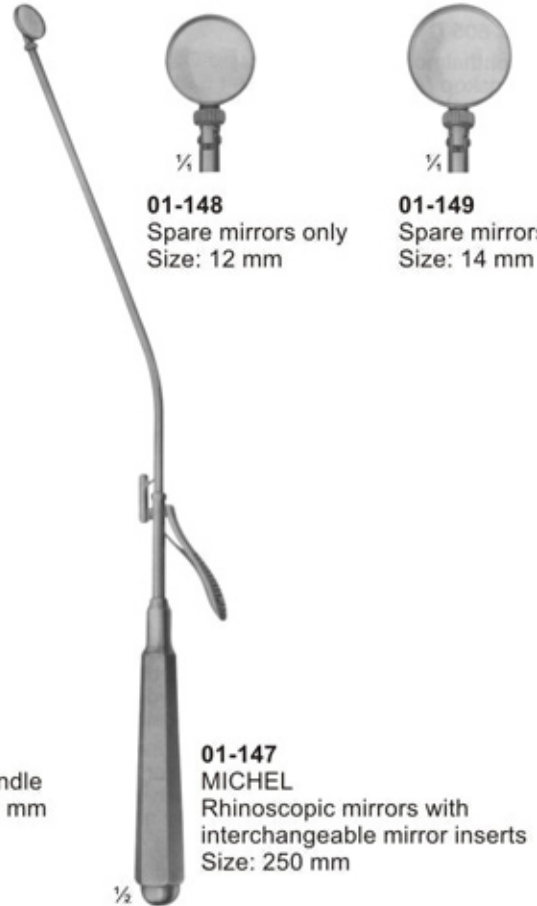
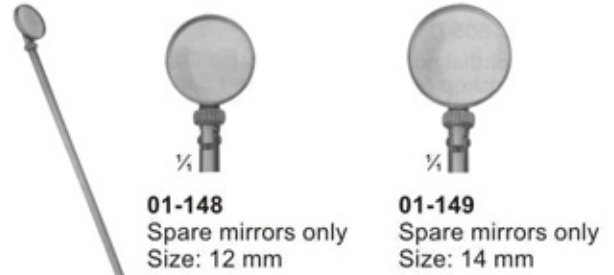

Laryngoscope and Diagnostic Sets



01-150
Infants
Size: 150 mm



01-151
Children
Size: 200 mm



01-152
Adults
Size: 250 mm



01-150 - 152
MAGILL



01-154



01-153
Medium battery handle
only, 25 mm diam.



01-153-A
Spare bulb
2.7 volt, for
otoscopes



01-153-B
Spare bulb
2.6 volt, for
ophthalmoscopes



01-155



01-156
Otoscope set, consists of
battery handle without batteries,
3 ear specula, 1 bulb in valvet lined case



01-157
Diagnostic set, otoscope with three specula,
nasal speculam, lamp holder, two laryngeal
mirrors, tongue blade holder

Laryngoscopes



1/3

01-158
MILLER
 Laryngoscope set, consists of battery handle (without battery)
 with four miller laryngoscope blades

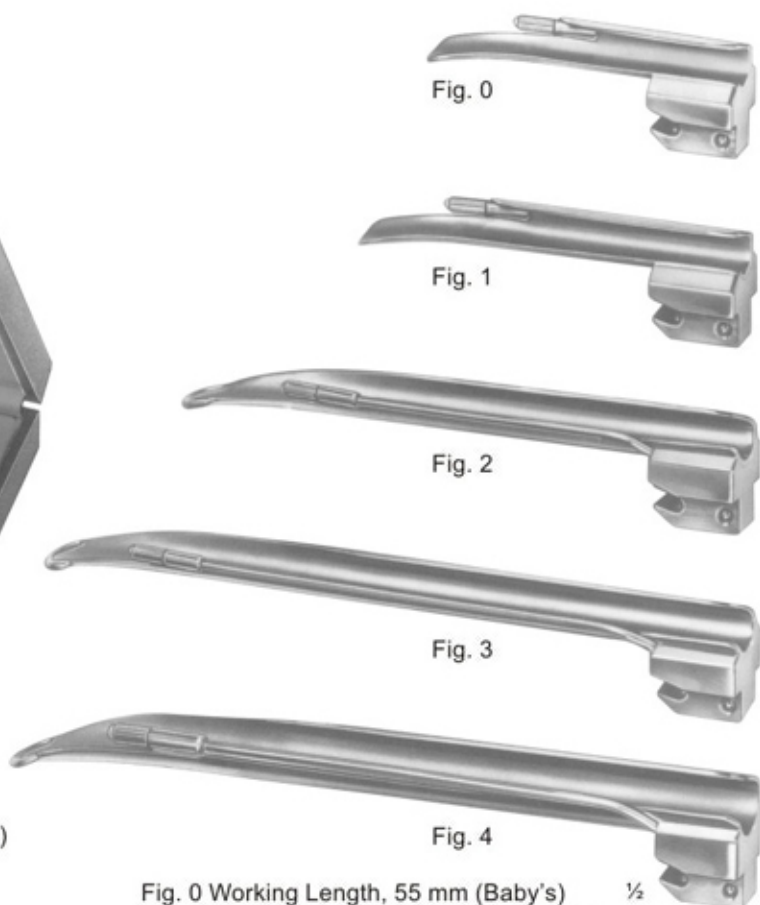

Fig. 0 Working Length, 55 mm (Baby's) 1/3
 Fig. 1 Working Length, 80 mm (Children's)
 Fig. 2 Working Length, 130 mm (Adolescent's)
 Fig. 3 Working Length, 170 mm (Women's)
 Fig. 4 Working Length, 180 mm (Men's)



1/3

01-159
GUEDEL-NEGUS
 Laryngoscope set, consists of battery handle (without battery)
 with four miller laryngoscope blades

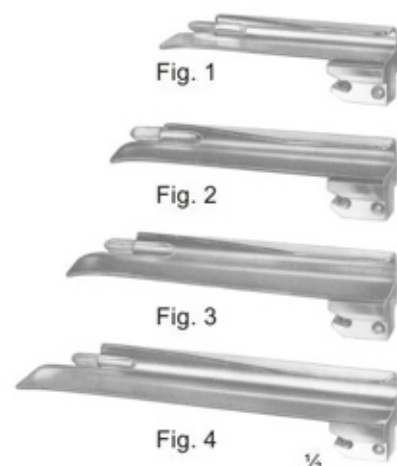

Fig. 1 Working Length, 70 mm (Children's) 1/3
 Fig. 2 Working Length, 90 mm (Adolescent's)
 Fig. 3 Working Length, 110 mm (Women's)
 Fig. 4 Working Length, 135 mm (Men's)

Laryngoscopes



1/3

01-160
McINTOSH
Laryngoscope Set, Consists Of Battery Handle (Without Battery)
With Three McIntosh Blades, Fig. 1, Fig. 2, Fig. 3

01-161
McINTOSH
Laryngoscope Set, Consists Of Battery Handle (Without Battery)
With Five McIntosh Blades, Fig. 0, Fig. 1, Fig. 2, Fig. 3, Fig. 4

Fig. 0

Fig. 1

Fig. 2

Fig. 3

Fig. 4

1/2

01-161 A Fig. 0 Working Length, 55 mm (Baby's)
01-161 B Fig. 1 Working Length, 75 mm (Children's)
01-161 C Fig. 2 Working Length, 90 mm (Adolescent's)
01-161 D Fig. 3 Working Length, 110 mm (Women's)
01-161 E Fig. 4 Working Length, 135 mm (Men's)

01-162
FOREGGER
Laryngoscope Set, Consists Of
Battery Handle (Without Battery)
With Three Foregger Blades,
Fig. 1, Fig. 2, Fig. 3,



1/3

01-163
FOREGGER
Laryngoscope Set, Consists Of
Battery Handle (Without Battery)
With Four Foregger Blades,
Fig. 1, Fig. 2, Fig. 3, Fig. 4,

Fig. 1

Fig. 2

Fig. 3

Fig. 4

1/2

01-162 A Fig. 1 Working Length, 70 mm (Children's)
01-162 B Fig. 2 Working Length, 90 mm (Adolescent's)
01-162 C Fig. 3 Working Length, 110 mm (Women's)
01-162 D Fig. 4 Working Length, 135 mm (Men's)



1/2

01-164
Fiber Optic
Battery Handle
30mm diam.



1/2

01-165
Fiber Optic
Battery Handle
18mm diam.



1/4

01-166
Replacement Lamp
(Krypton) 2.5 V



1/4

01-167
Replacement Lamp
(Halogen) 2.5 V

Examination & Measuring Instruments

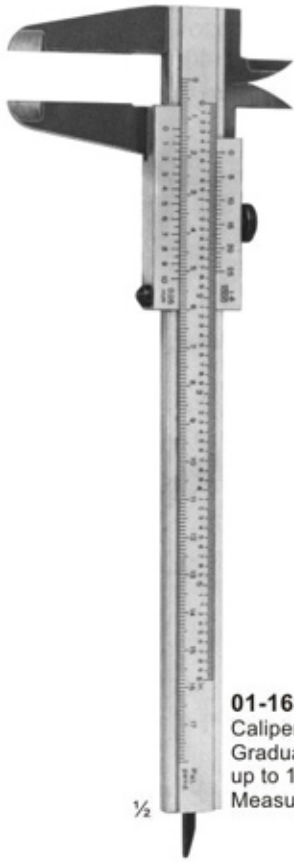

01-168
Caliper Of Aluminium
Graduated in mm & inches
up to 180mm
Measuring Range up to 139mm



01-169
VERNIER
Universal Caliper Of Steel
Graduated in mm & inches
up to 180mm
Measuring Range up to 120mm
with Vernier in 1/10mm & 1/16"



01-170
CARROLL
Size: 145 mm
Finger Goniometer



01-171
TOWNLEY
Graduated in
mm & inches
Size: 115 mm



01-172
COLLIN
Druck Pressure 72 kg
Size: 125 mm



01-173
BERTILLON
Caliper For Measuring The Head
Size: 320 mm



01-174
CASTROVIEJO
Caliper
Size: 75mm



01-175
MOLTGEN
Goniometer



01-176
Size: 150 mm



01-177
Size: 500 mm



Dissecting Knives



1/2
02-101 - 110
 Fig. 1 - 10



1/4
02-101
 Fig. 1
 30 mm



02-102
 Fig. 2
 36 mm



02-103
 Fig. 3
 40 mm



02-104
 Fig. 4
 45 mm



02-105
 Fig. 5
 50 mm



1/4
02-106
 Fig. 6
 27 mm



02-107
 Fig. 7
 35 mm



02-108
 Fig. 8
 40 mm



02-109
 Fig. 9
 47 mm



02-110
 Fig. 10
 50 mm

Amputating Knives, Cartilage Knives and Autopsy Knives



- LISTON**
02-111
Size: 130 mm
- 02-112**
Size: 160 mm
- 02-113**
Size: 190 mm
- 02-114**
Size: 200 mm
- 02-115**
CATLIN
Size: 160 mm
- 02-116**
LANGENBECK
Size: 120 mm
- 02-117**
Size: 110 mm
Blade length
Interosseous
Knives
- 02-118**
Size: 55 mm
Blade length
with raspatory,
Wooden handle
- 02-119**
Size: 70 mm
Blade length
Wooden handle
- 02-120**
Size: 80 mm
Blade length
Metal handle
- 02-121**
Size: 195 mm
Blade length
Metal handle

Blade length
Amputating Knives

Cone Knives, Myomatome, Trigeminal and Tonsil Knives



02-122
AYRE
 Size: 235 mm
 Cone Knife

02-123
 Size: 230 mm
 Cone Knife

02-124
SEGOND
 Size: 270 mm
 Myomatome

02-125
OLIVECRONA
 Size: 205 mm
 Trigeminal
 Knife

02-126
 Size: 230 mm
 Trigeminal
 Knife

02-127
FOWLER
 Size: 200 mm
 Tonsil Knife

02-128
ABRAHAM
 Size: 215 mm
 Tonsil Knife

02-129
BRUNINGS
 Size: 215 mm
 Tonsil Knife

Scalpel Handles

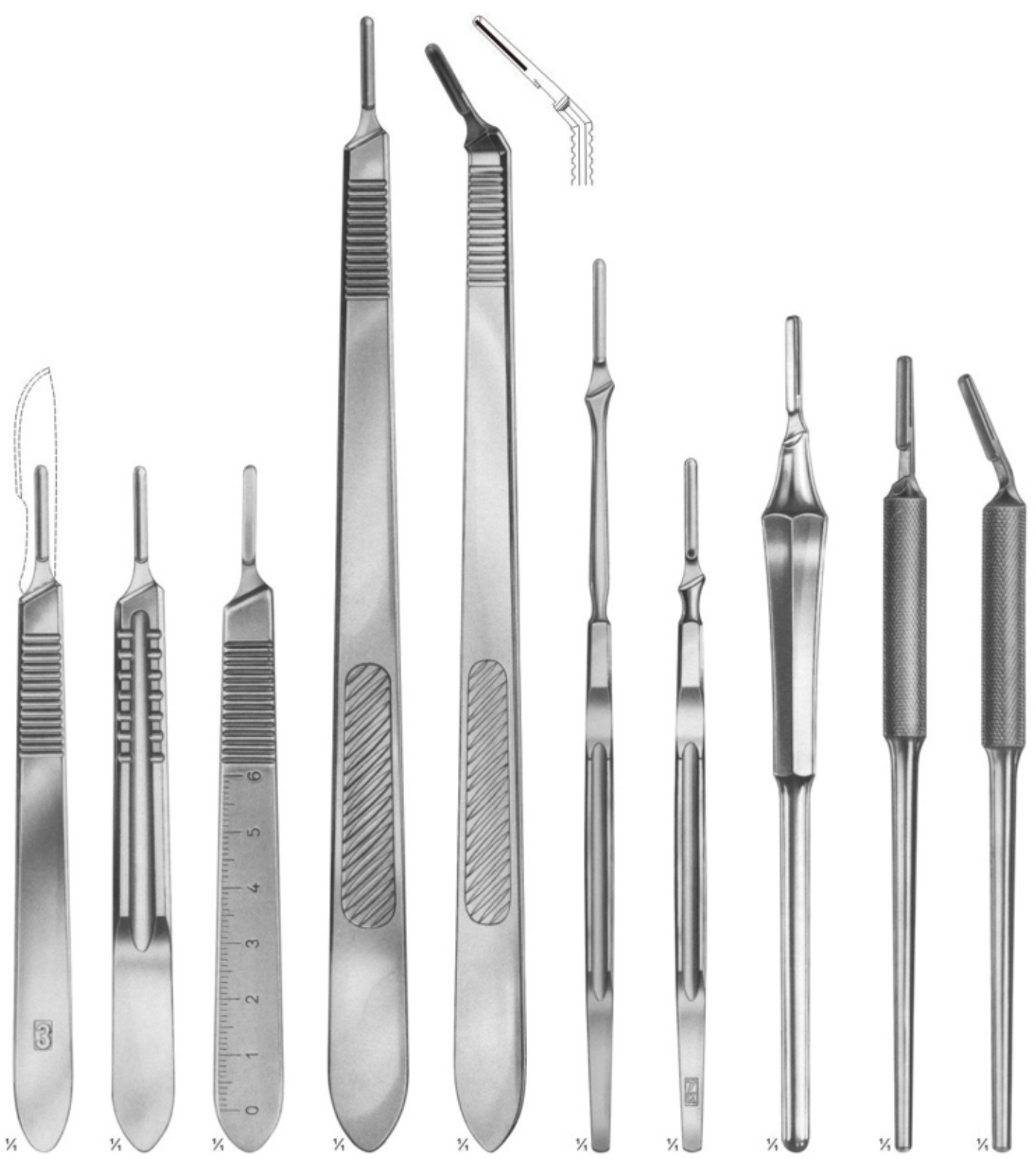

$\frac{1}{2}$	$\frac{1}{2}$	$\frac{1}{2}$	$\frac{1}{2}$	$\frac{1}{2}$	$\frac{1}{2}$	$\frac{1}{2}$	$\frac{1}{2}$	$\frac{1}{2}$	$\frac{1}{2}$
02-130 STANDARD No. 3 Solid 12 cm	02-131 No. 3 Solid 12 cm	02-132 No. 3 Solid 12 cm	02-133 No. 3 L Straight Solid 21.5 cm	02-134 No. 3 L Angled Solid 21 cm	02-135 No. 7 Solid 16 cm	02-136 No. 7 K Solid 12.5 cm	02-137 Hollow-Round 15.5 cm	02-138 No. 3 Straight Solid, Round 14.5 cm	02-139 No. 3 Angled Solid, Round 14 cm

Micro Scissors (Spring Type) with Flat Handles

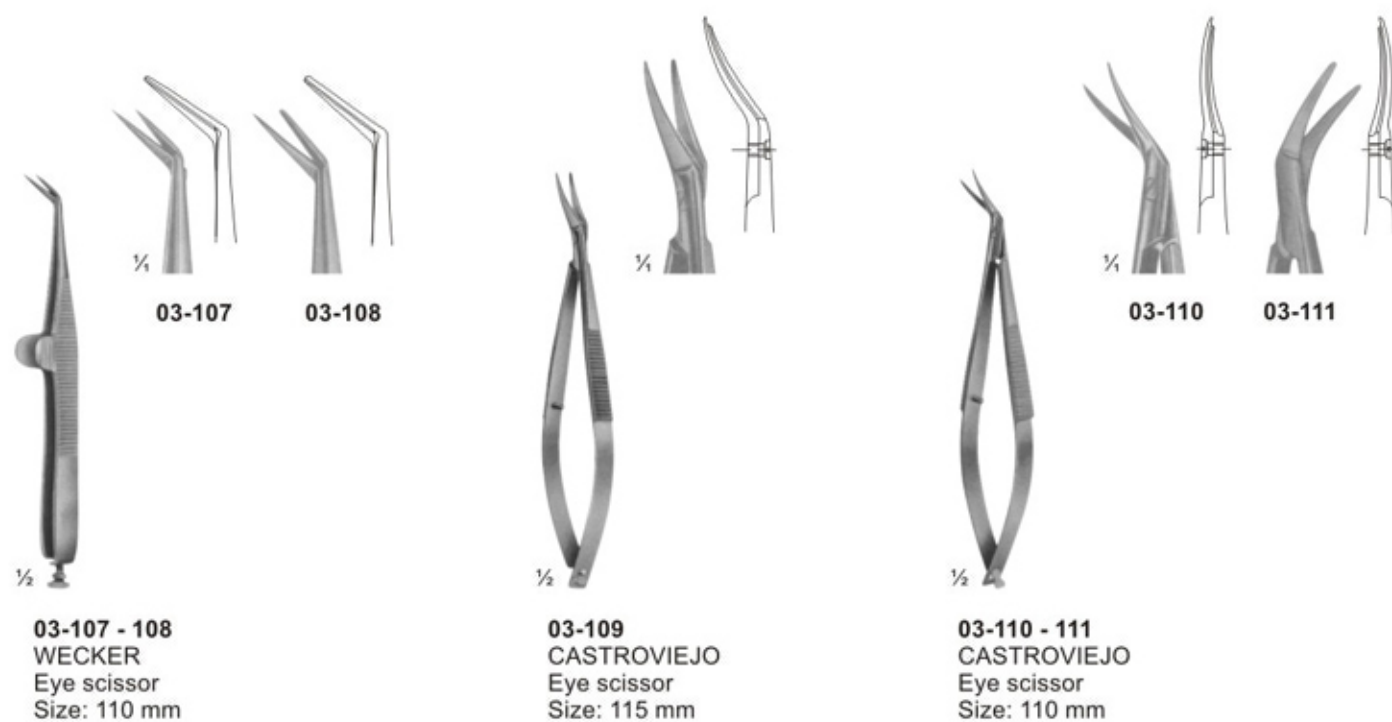
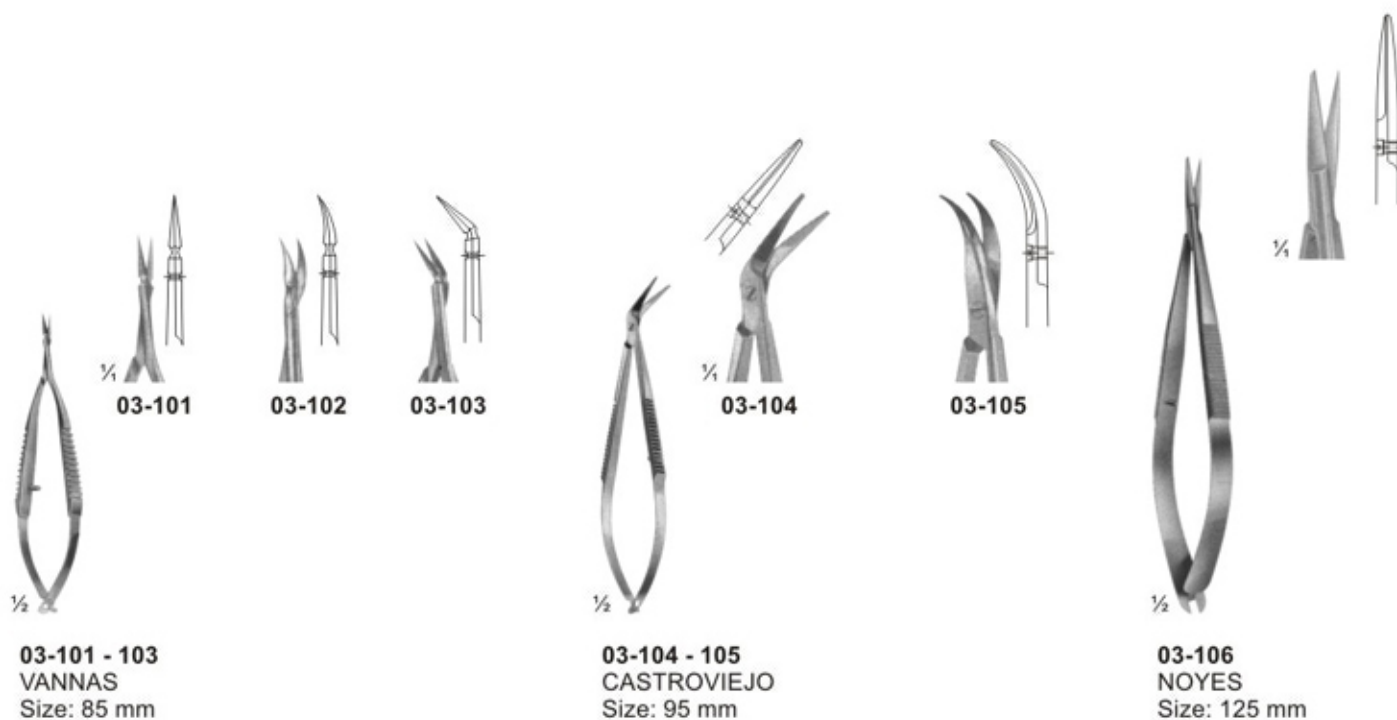

Micro Scissors (Spring Type) with Flat Handles

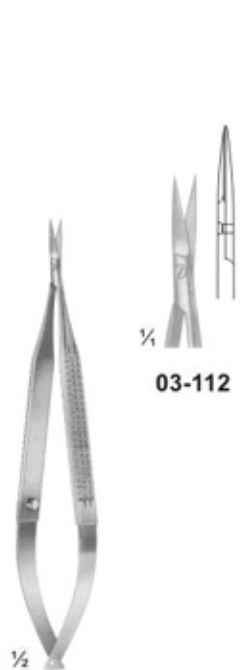

03-112



03-113



03-114
BIEMER
Vein scissor
Size: 130 mm



03-115
Size: 160 mm



03-116

03-117

03-116 - 117
VANNAS
Size: 160 mm

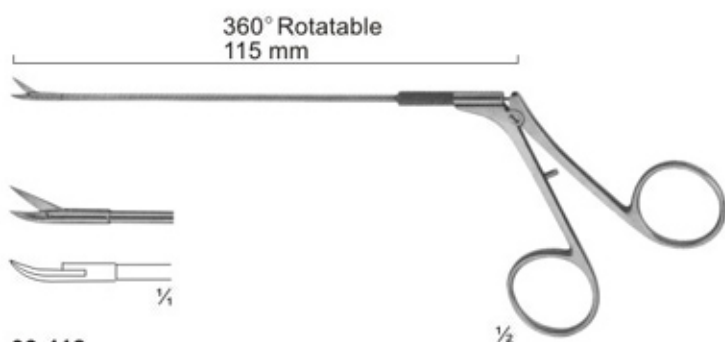

03-118
CASPAR
Micro scissor curved
Size: 115 mm



03-119



03-120



03-121



03-119 - 121
Micro dissecting scissor
Size: 145 mm

Micro Scissors (Spring Type) bayonet-Shaped



03-122
YASARGIL
Size: 245 mm



03-123
45°



03-124
45°



03-123 - 124
laterally angled
Size: 200 mm



125°



03-125
laterally angled
Size: 190 mm

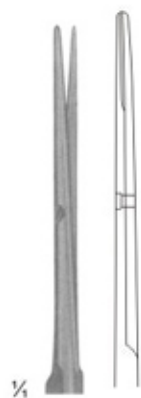

03-126



03-127



03-126 - 127
YASARGIL
Size: 225 mm

Delicate Scissors

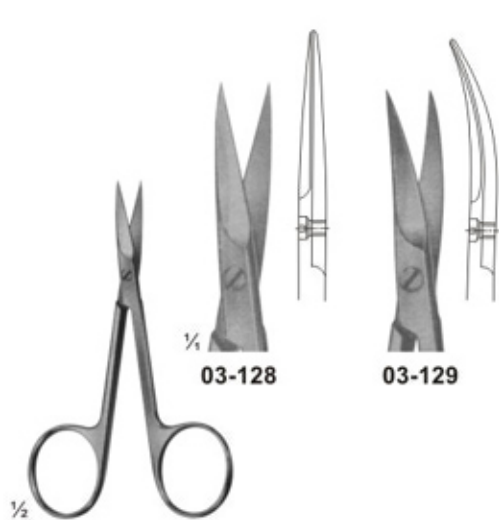

03-128 - 129
Size: 90 mm



03-130 - 131
Size: 95 mm

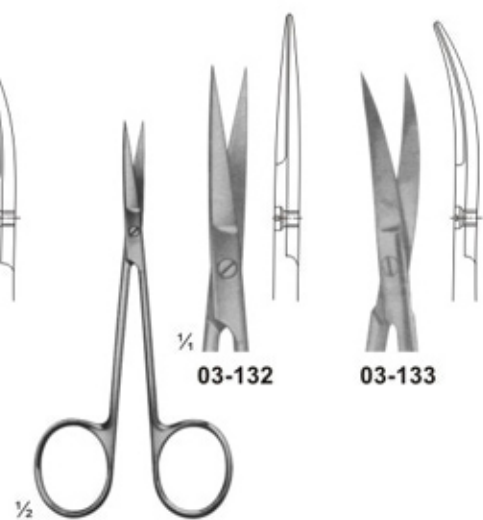

03-132 - 133
Size: 105 mm

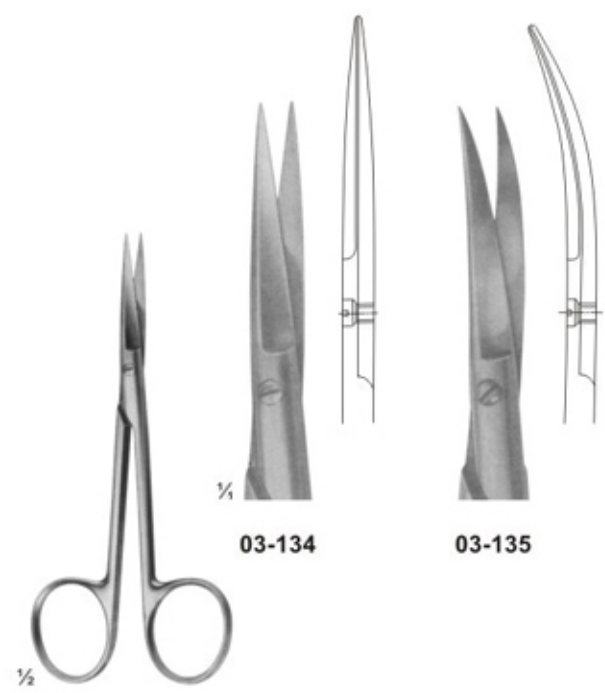

03-134 - 135
Size: 120 mm



03-136 - 137
Size: 115 mm

Delicate Scissors



03-138



03-139



03-140



03-138 - 140
Size: 120 mm



03-141



03-142



03-143



03-144

03-141 - 144
Size: 130 mm

Surgical Scissors

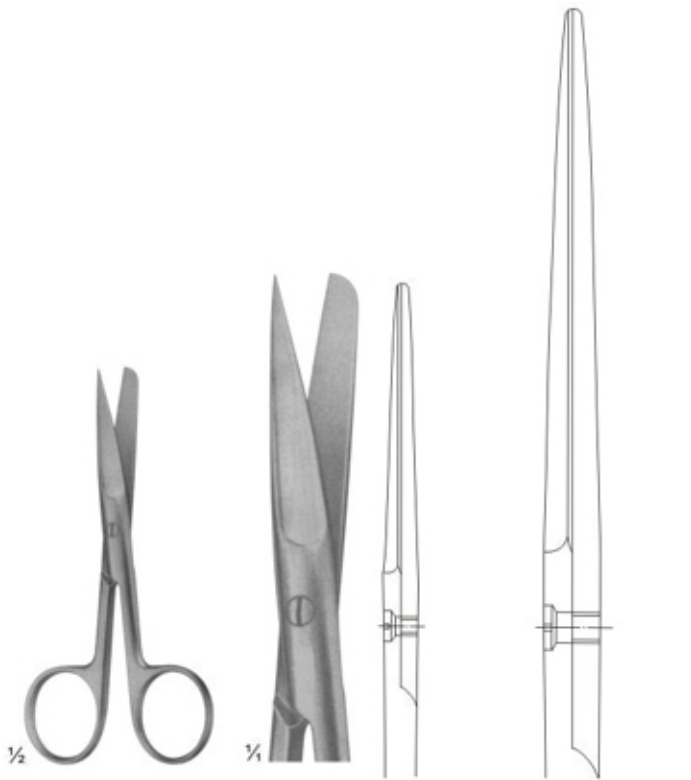

03-145 - 153 (Standard types)
 03-145 (105 mm)
 03-146 (115 mm)
 03-147 (130 mm)
 03-148 (145 mm)
 03-149 (150 mm)
 03-150 (165 mm)
 03-151 (175 mm)
 03-152 (185 mm)
 03-153 (200 mm)

03-145
 Size: 105 mm

03-153
 Size: 200 mm



03-154 - 160 (Standard types)
 03-154 (115 mm)
 03-155 (130 mm)
 03-156 (145 mm)
 03-157 (150 mm)
 03-158 (165 mm)
 03-159 (175 mm)
 03-160 (185 mm)

03-154
 Size: 115 mm

03-160
 Size: 185 mm

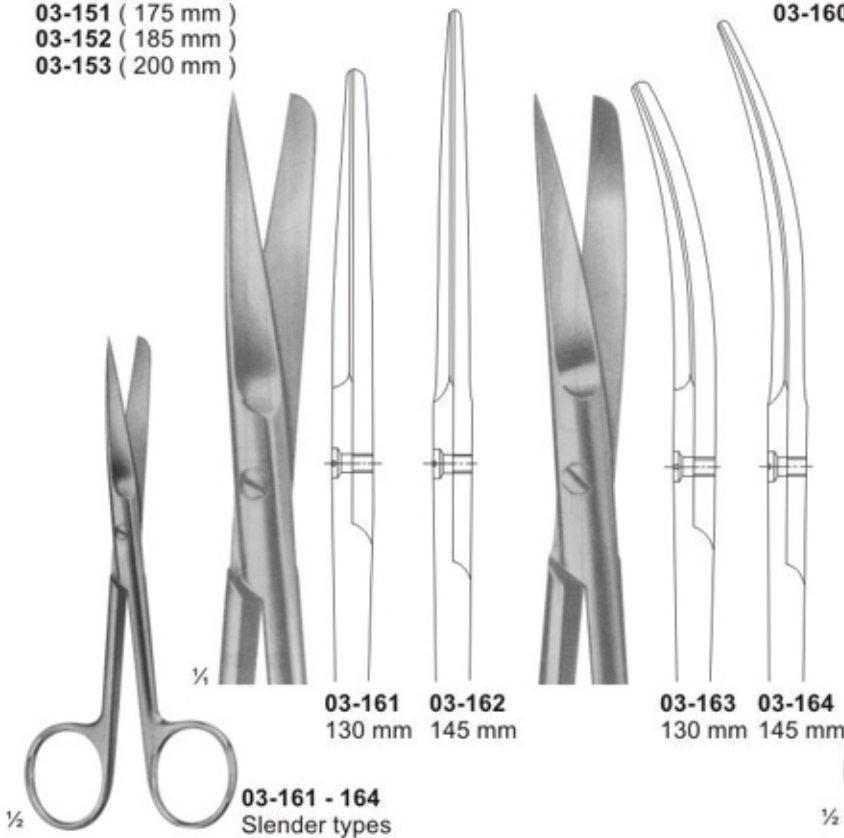

03-161 - 164
 Slender types

03-161
 130 mm

03-162
 145 mm

03-163
 130 mm

03-164
 145 mm

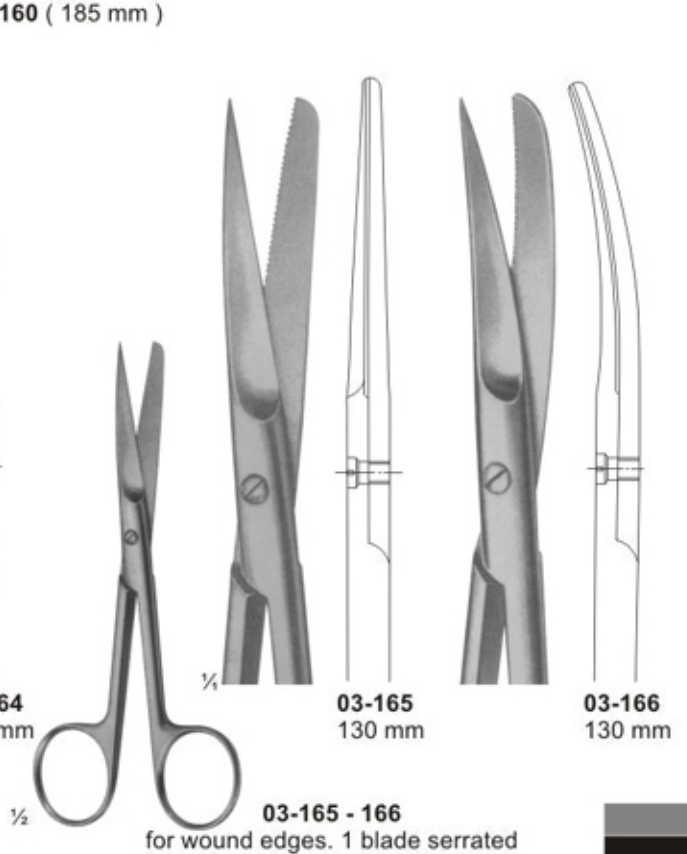

03-165 - 166
 for wound edges. 1 blade serrated

03-165
 130 mm

03-166
 130 mm

Surgical Scissors



03-167 - 169
DEAVER
with flat lock

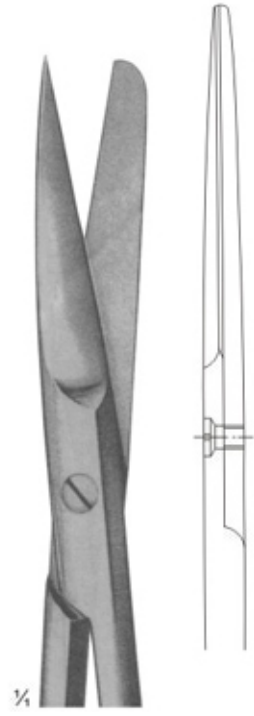

03-167
Size: 145 mm

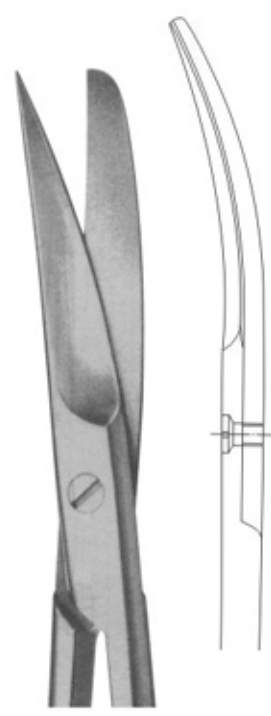

03-168
Size: 145 mm

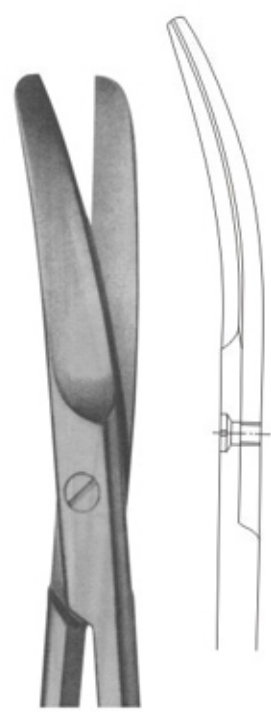

03-169
Size: 145 mm



03-170 - 172
Incision scissors

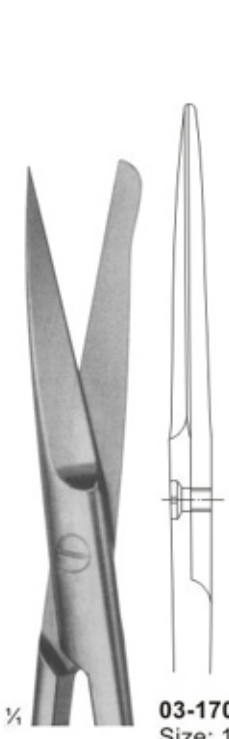

03-170
Size: 130 mm



03-171
Size: 145 mm



03-172
Size: 165 mm



03-173
SYSTRUNK
Nail splitting scissors

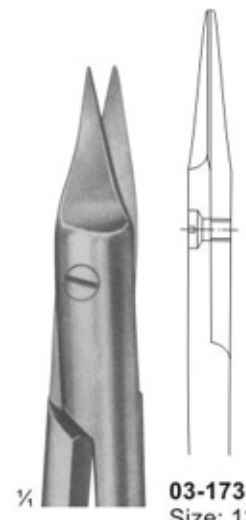

03-173
Size: 130 mm

Dissecting Scissors

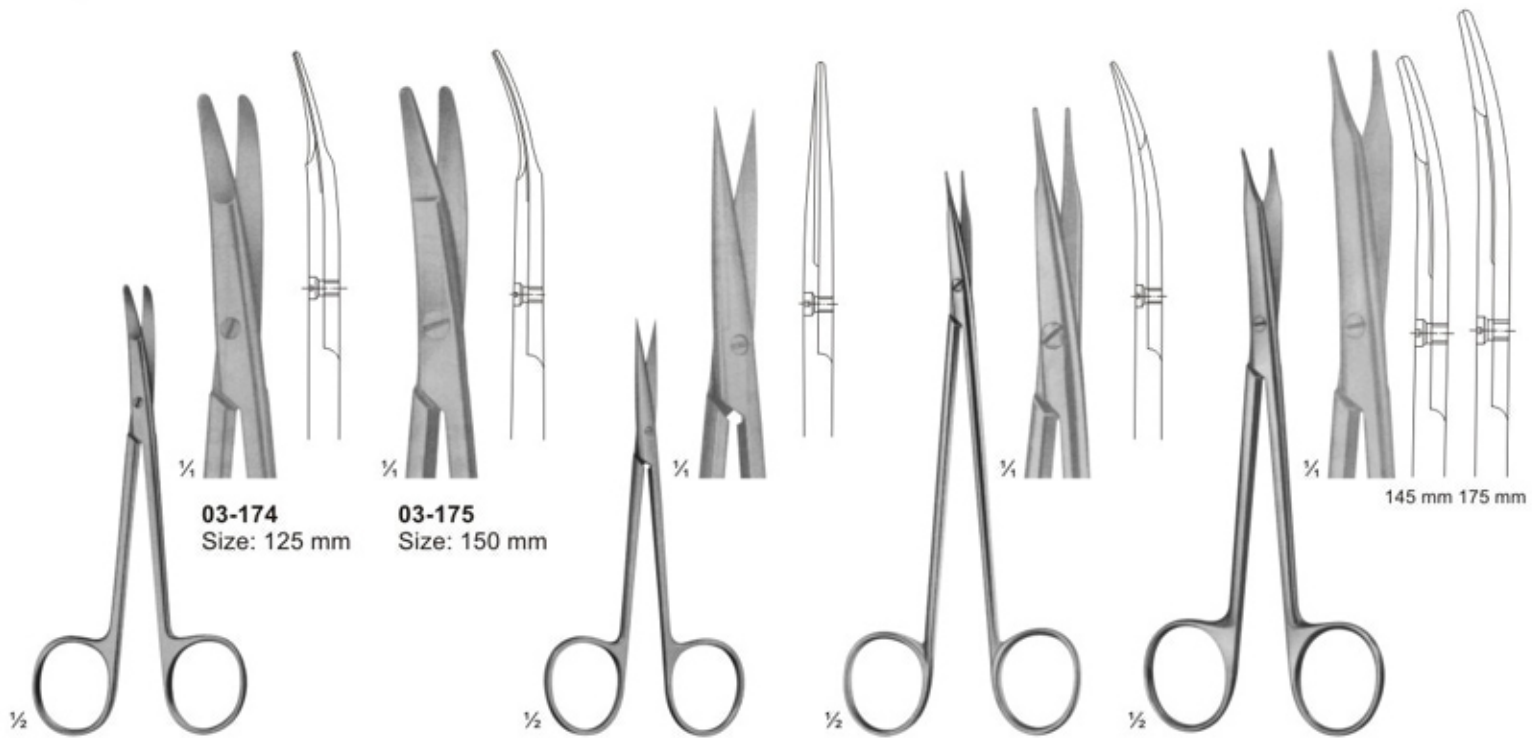

03-174 - 175
KILNER
 Special flat points for dissecting and undermining the skin

03-176
KILNER
 Fine dissecting scissors
 Size: 115 mm

03-177
JAMESON
 Dissecting scissors
 Size: 150 mm

03-178
REYNOLDS
 Dissecting scissors
 Size: 145 - 175 mm

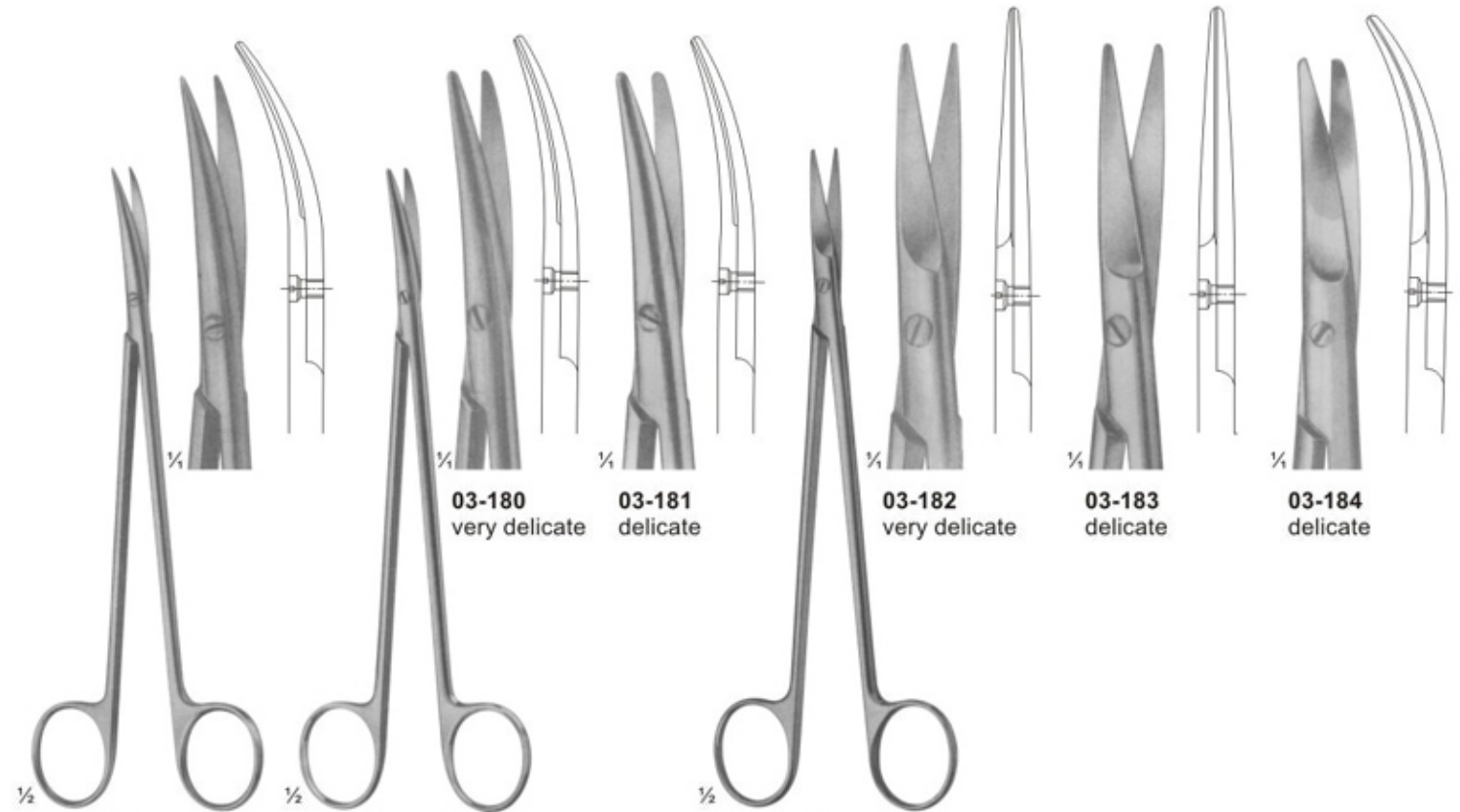

03-179
DE BAKEY
 Arteriotomy scissors
 Size: 175 mm

03-180 - 181
TOENNIS ADSON
 Dissecting scissors
 Size: 175 mm

03-182 - 184
TOENNIS
 Dissecting scissors
 Size: 180 mm

Dissecting Scissors

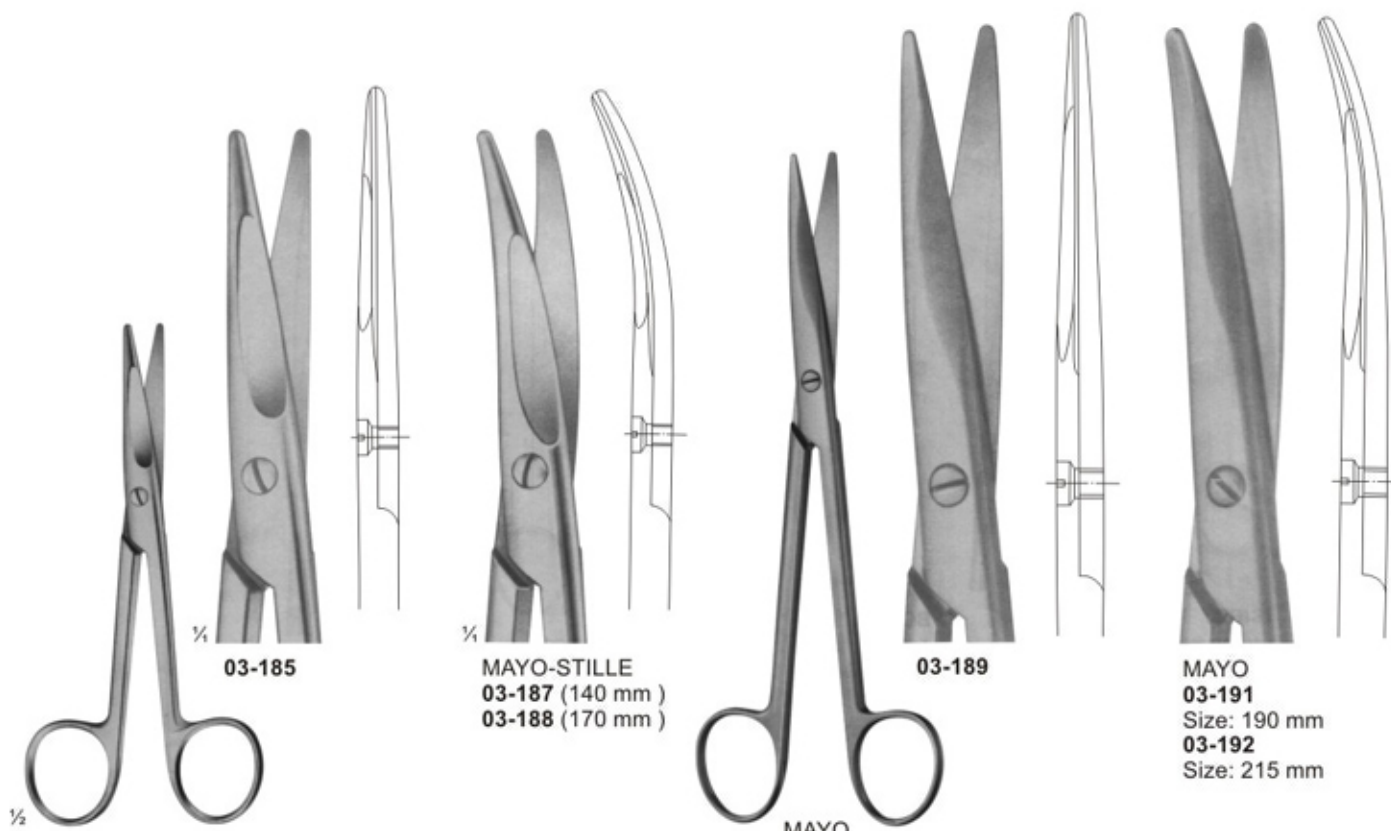

03-185 - 186
MAYO-STILLE
 with chamfered blades
03-185 (140 mm)
03-186 (170 mm)

MAYO
 with chamfered blades
03-189 (190 mm)
03-190 (215 mm)

MAYO
03-191
 Size: 190 mm
03-192
 Size: 215 mm

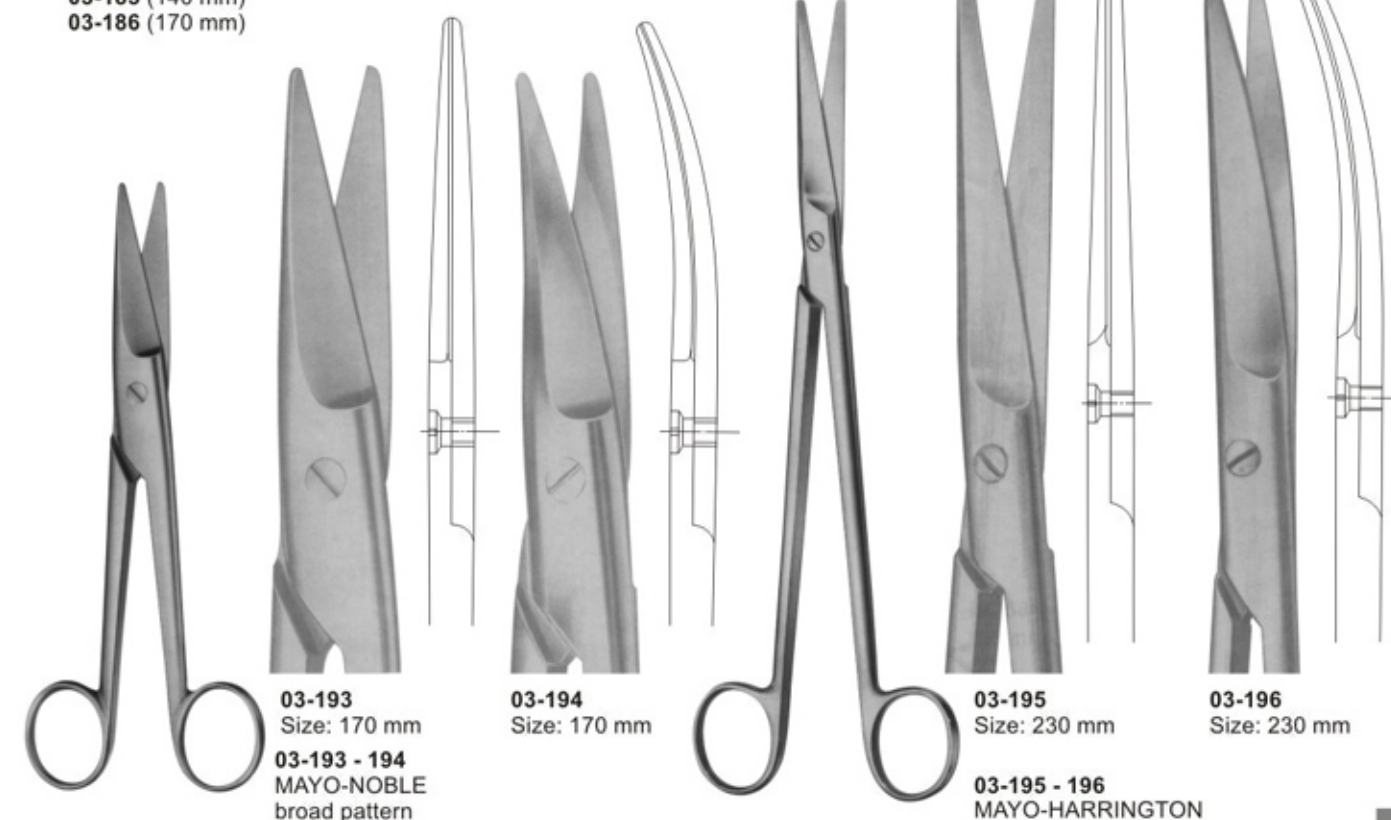

03-193
 Size: 170 mm
03-193 - 194
MAYO-NOBLE
 broad pattern

03-194
 Size: 170 mm

03-195
 Size: 230 mm

03-196
 Size: 230 mm

03-195 - 196
MAYO-HARRINGTON

Scissors for Cardiovascular and Neuro-Surgery



03-197
OLIVECRONA
Dura scissors

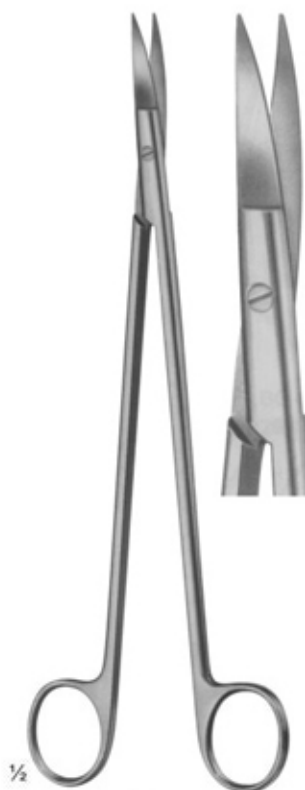

03-198
STRULLY
pointed
Size: 220 mm

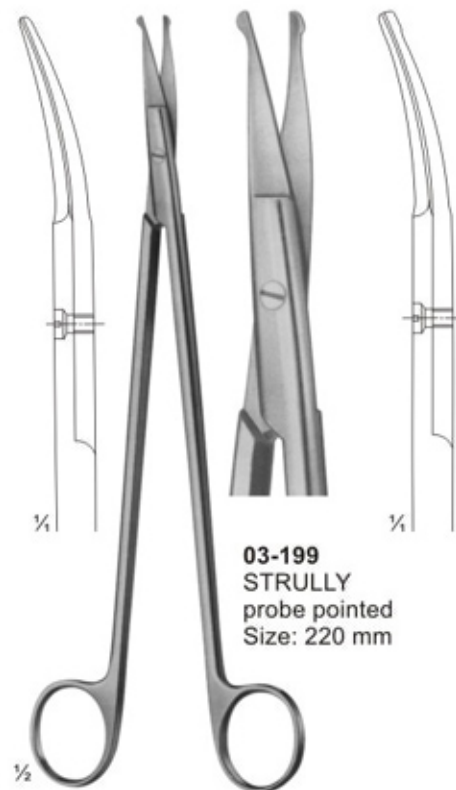

03-199
STRULLY
probe pointed
Size: 220 mm

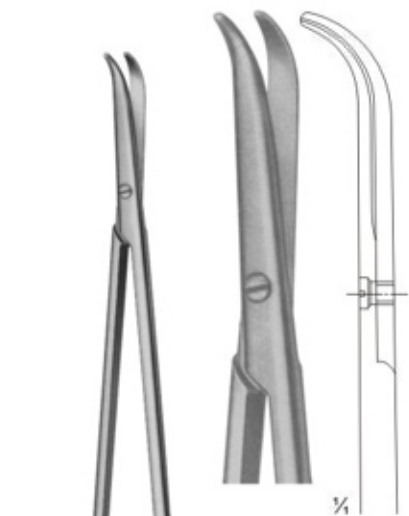

03-200
THOREK
Size: 180 mm

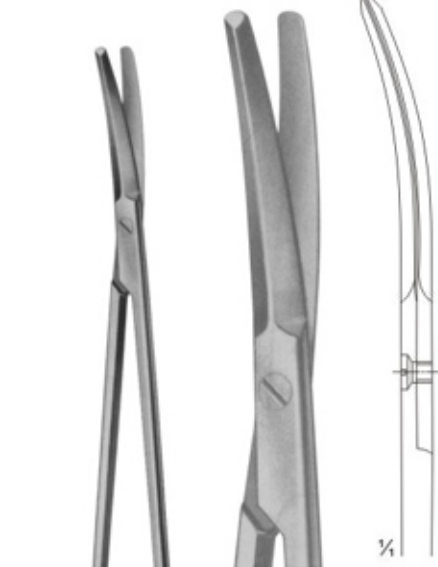

03-201
POTTS-SMITH
Size: 190 mm

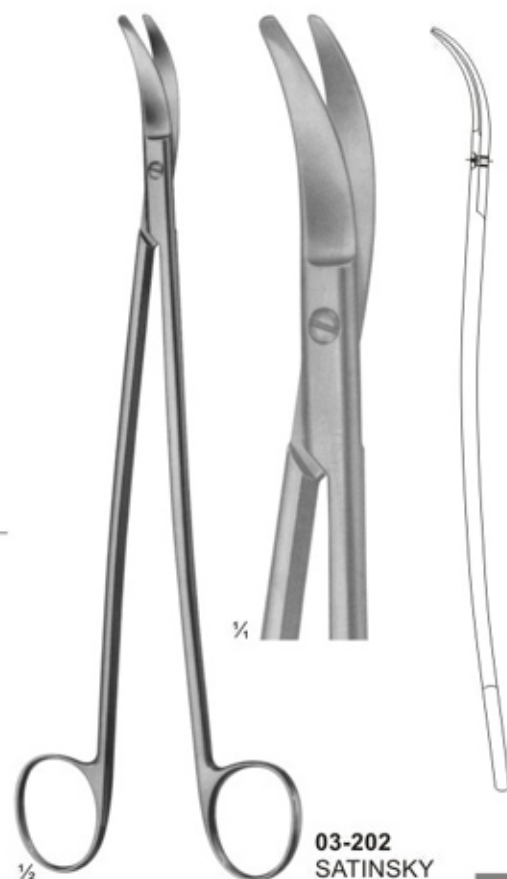

03-202
SATINSKY
Size: 245 mm

Delicate, Nasal and Tonsil Scissors

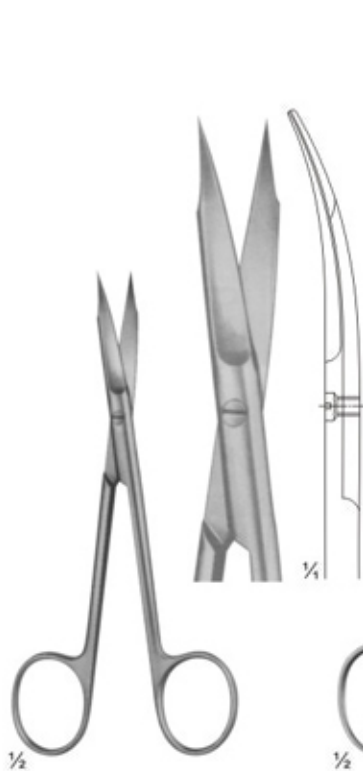

03-203
1 finely toothed blade
Size: 130 mm

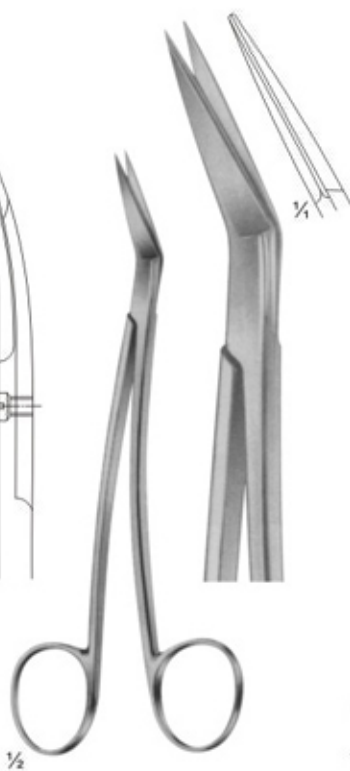

03-204
LOCKLIN
curved sideways,
1 toothed blade
Size: 155 mm



03-205
FOMON
blades serrated
Size: 145 mm

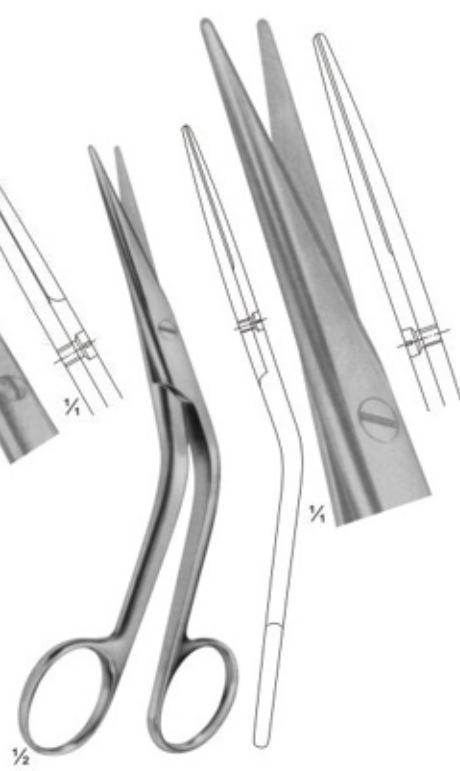

03-206
COTTLE
Size: 165 mm



03-207
HEYMANN-KNIGHT
Size: 175 mm

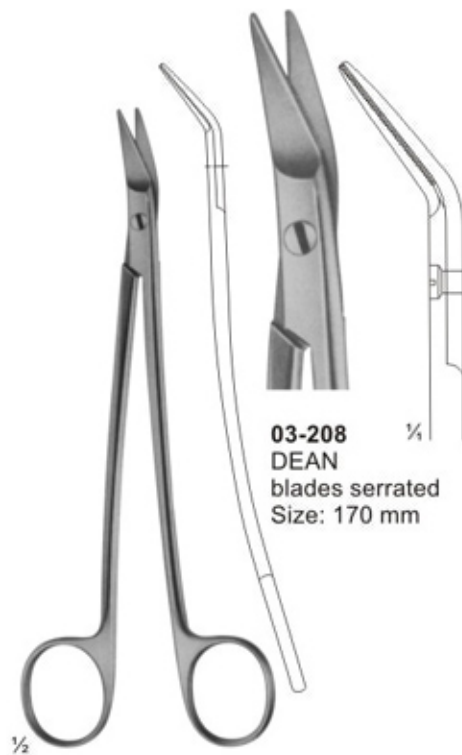

03-208
DEAN
blades serrated
Size: 170 mm

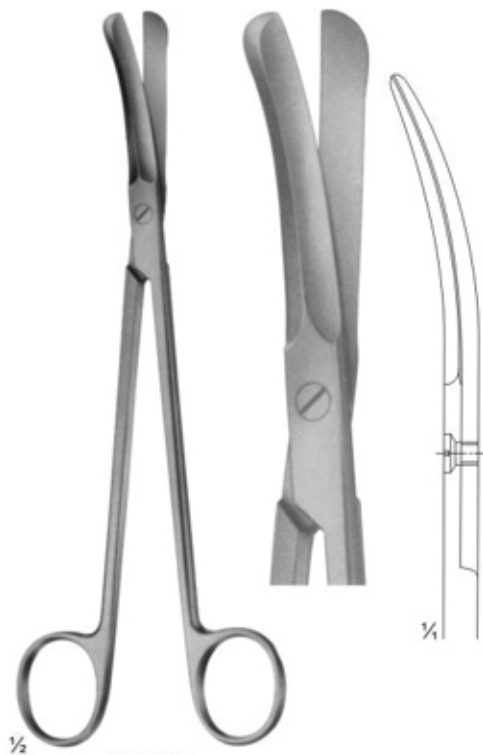

03-209
GOOD
Size: 195 mm

Bone Shears

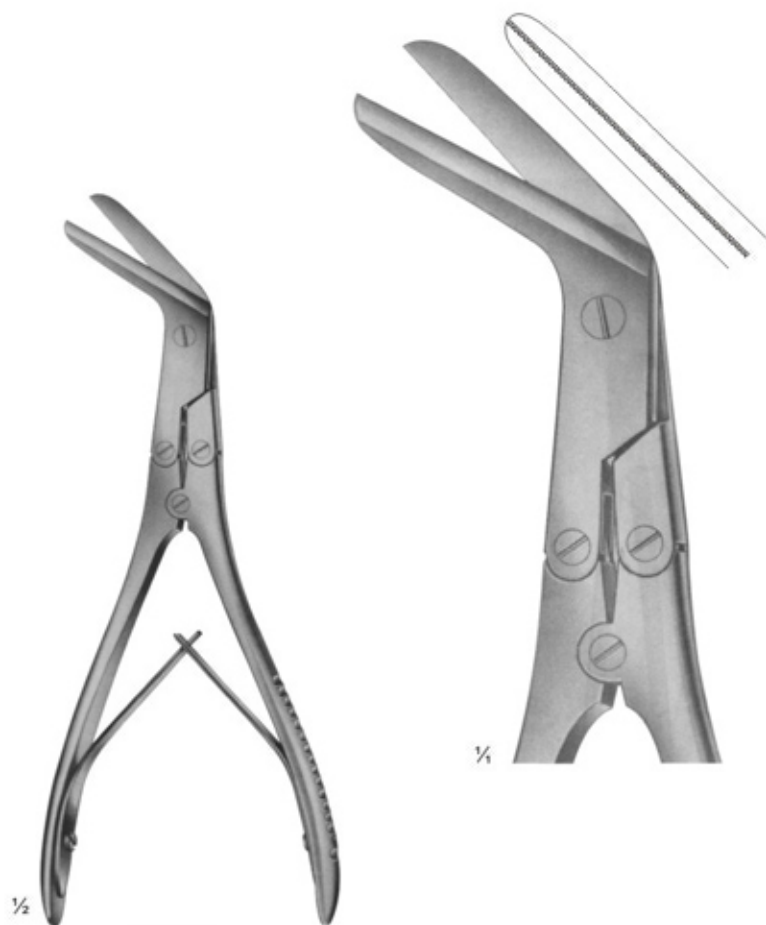

03-210
KILLIAN
Size: 200 mm



03-211 - 03-212

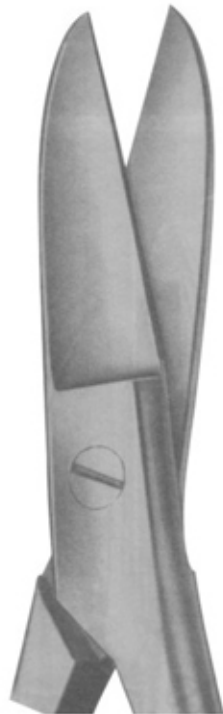

03-211
195 mm



03-212
225 mm

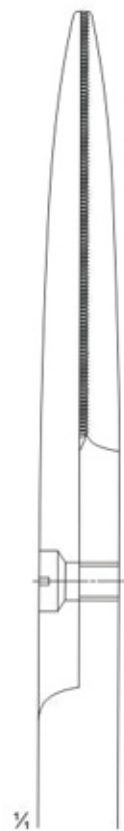

**Scissors for deep operations and
for Gynaecology**

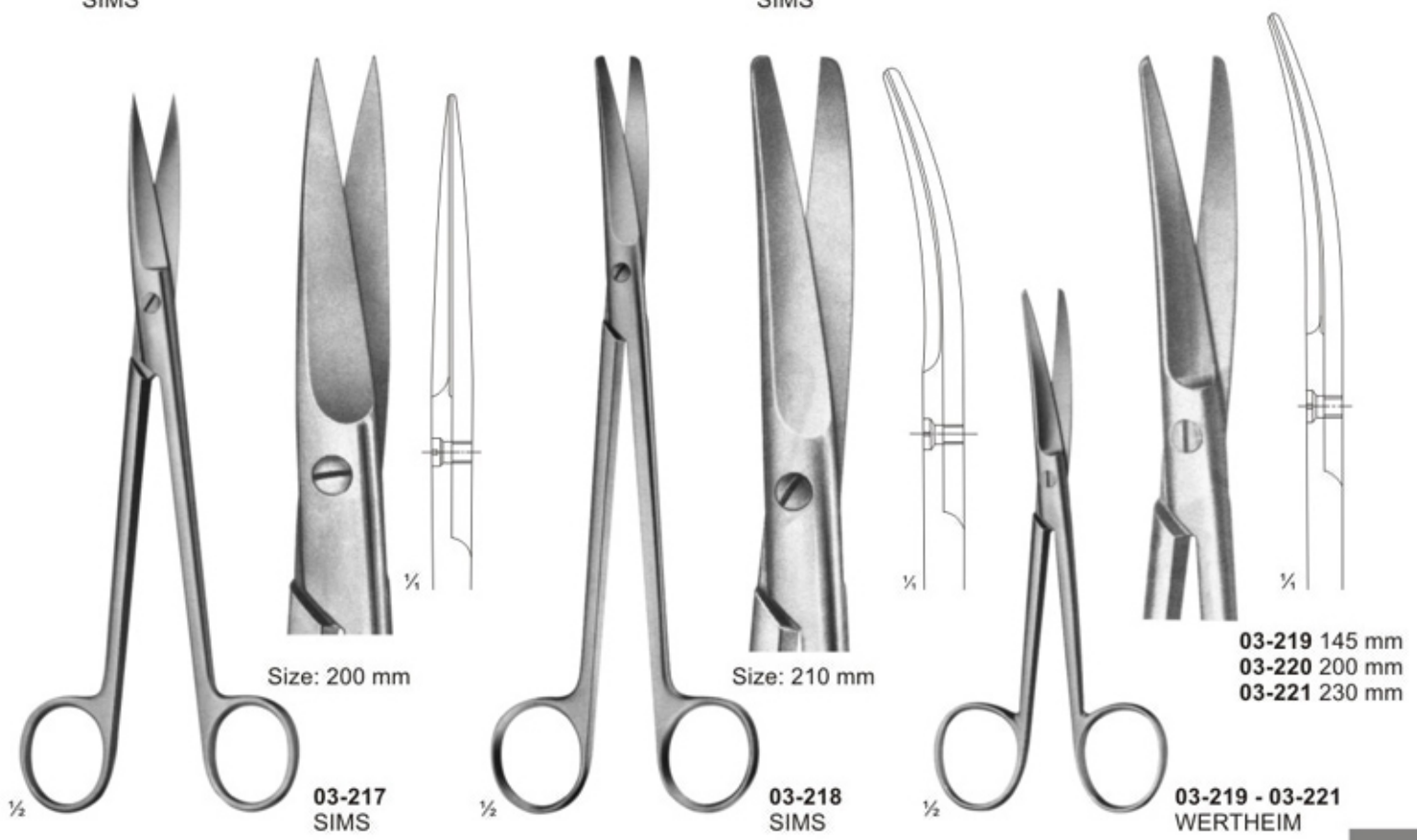
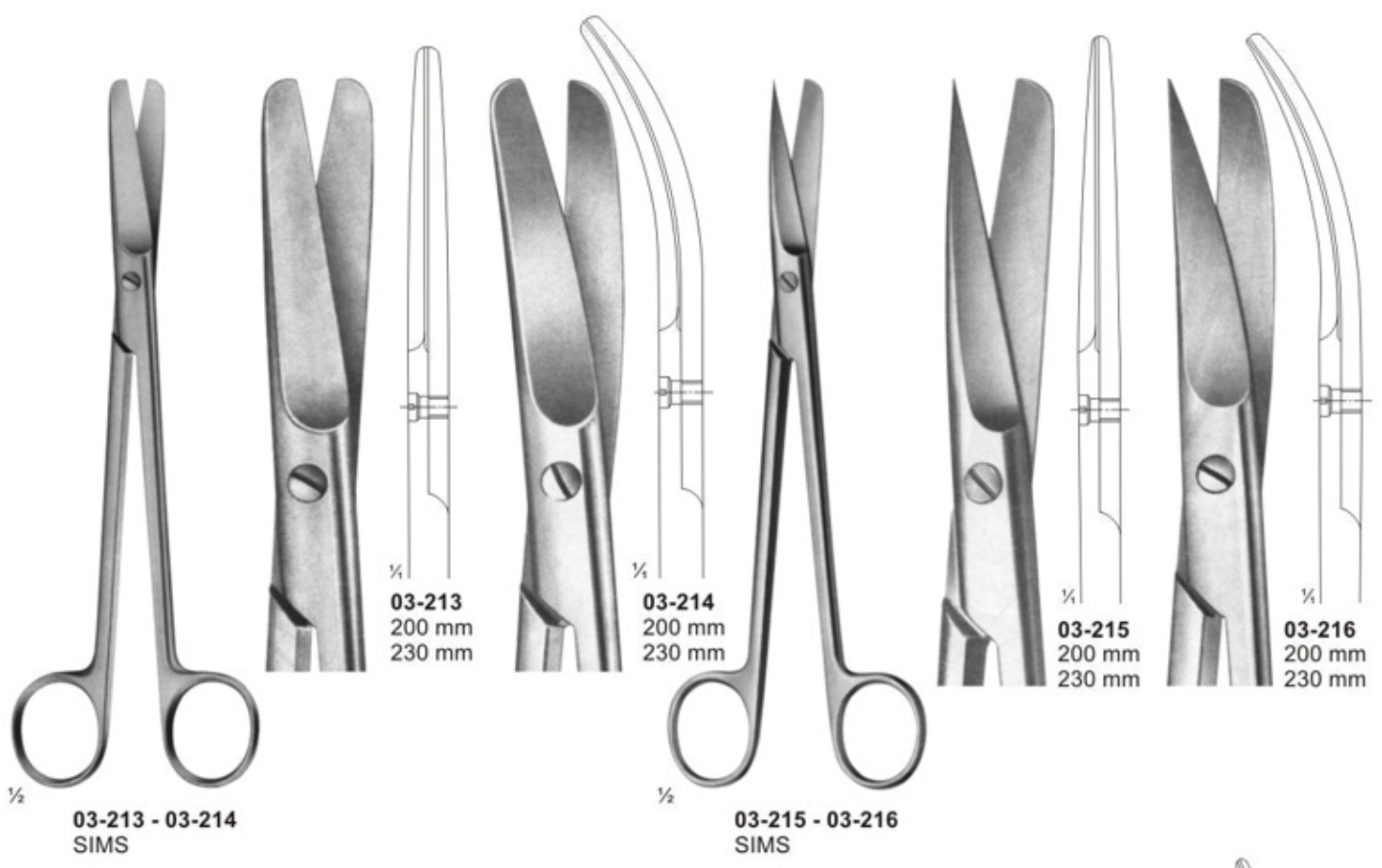

Scissors for Obstetrics



03-222
SCHUMACHER
 Umbilical cord scissors
 Size: 155 mm

03-223
 Umbilical cord scissors
 Size: 105 mm

03-224
 Umbilical cord scissors

135 mm



03-225 - 03-226
BRAUN-STADLER
 Episiotomy scissors

03-225
 145 mm

03-226
 200 mm

03-227
 Episiotomy scissors
 240 mm

Wire and Plate Scissors



1/2

03-228 - 03-232
BEEBE
Size: 110 mm

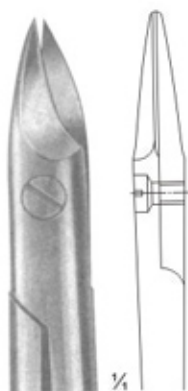

03-228

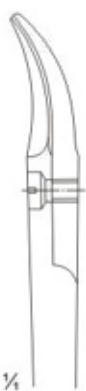

03-229

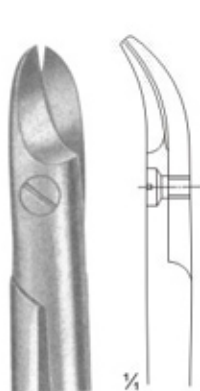

03-230
broad blades

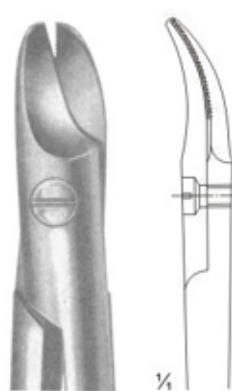

03-231
1 blade serrated

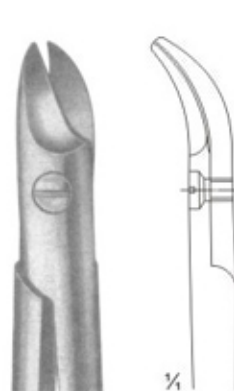

03-232
NAUJOKS
strongly curved

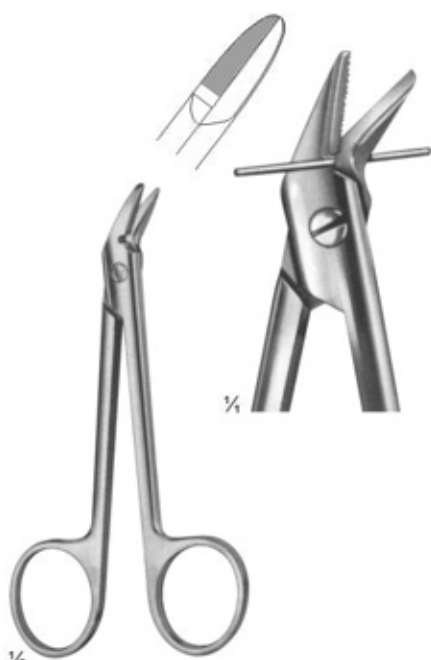

1/2

03-233
1 blade serrated
Size: 120 mm

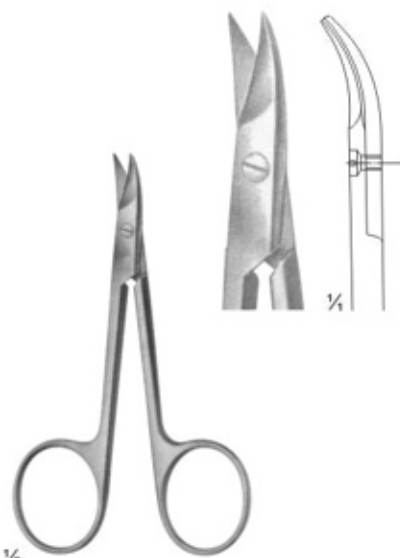

1/2

03-234
STRACK
Size: 100 mm

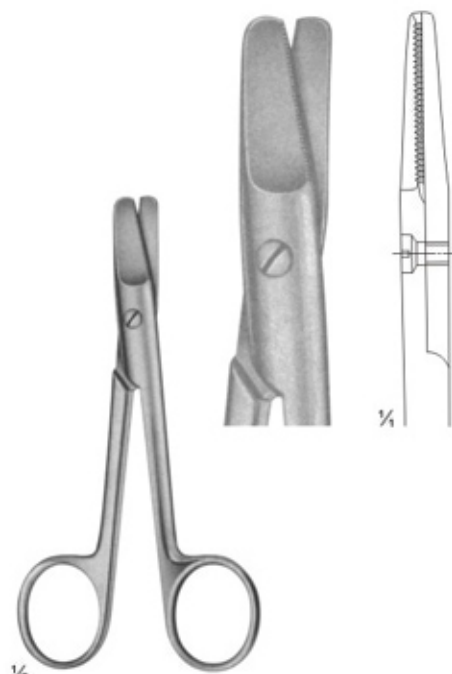

1/2

03-235
HARVEY
blades serrated
Size: 125 mm

Bandage and Cloth Scissors



½

03-236
Universal bandage and cloth scissors,
with toothed edges
180 mm

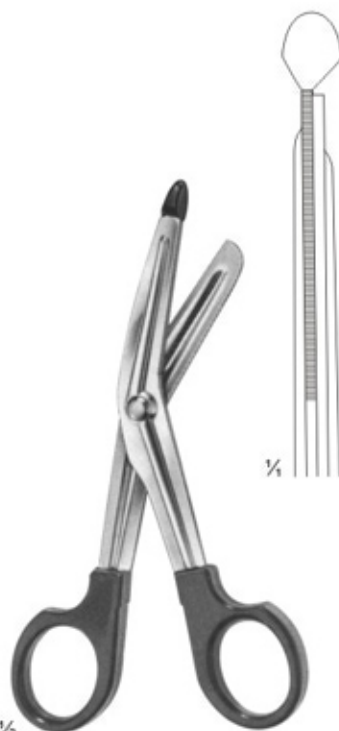

½

03-237
LISTER
Universal bandage and cloth scissors,
with toothed edges
Size: 145 mm

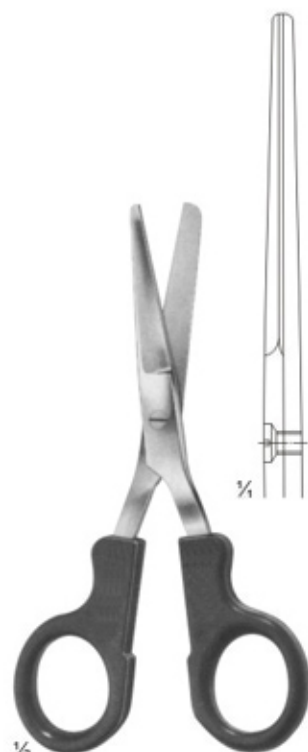

½

03-238
LISTER
Nurse's scissors
Size: 145 mm

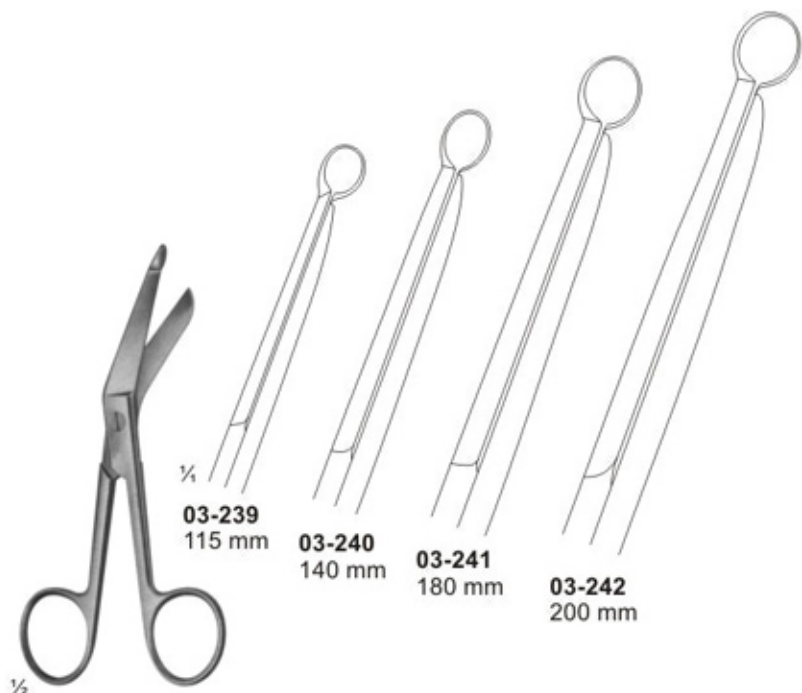

½

03-239 - 03-242
LISTER

03-239
115 mm

03-240
140 mm

03-241
180 mm

03-242
200 mm

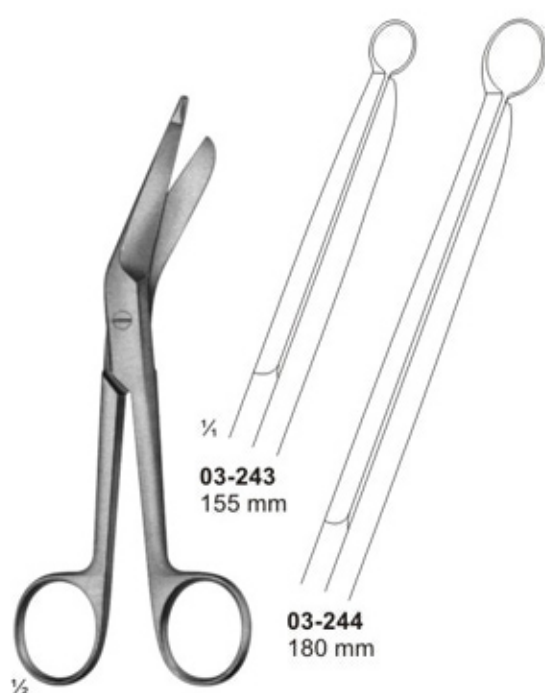

½

03-243 - 03-244
LISTER

03-243
155 mm

03-244
180 mm

Bandage-, Cloth-, and Plaster Scissors



03-245
CLOTH SCISSORS
205 mm



03-246
BRAUN-STADLER
225 mm



03-247
SEUTIN
230 mm



03-248 200 mm
03-249 230 mm

03-248 - 03-249
ESMARCH

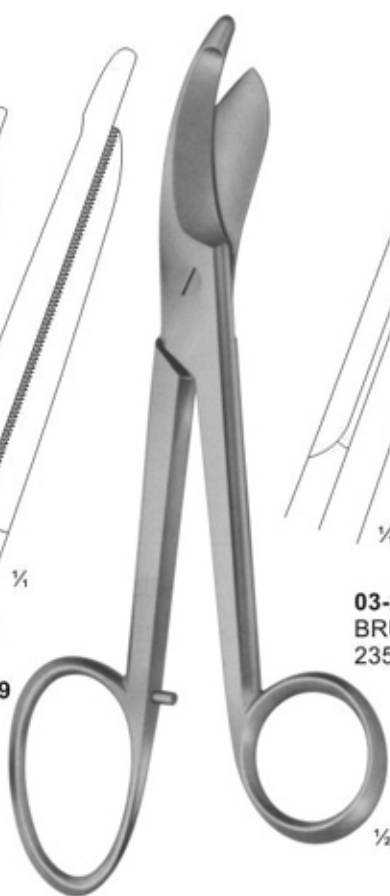

03-250
BRUNS
235 mm

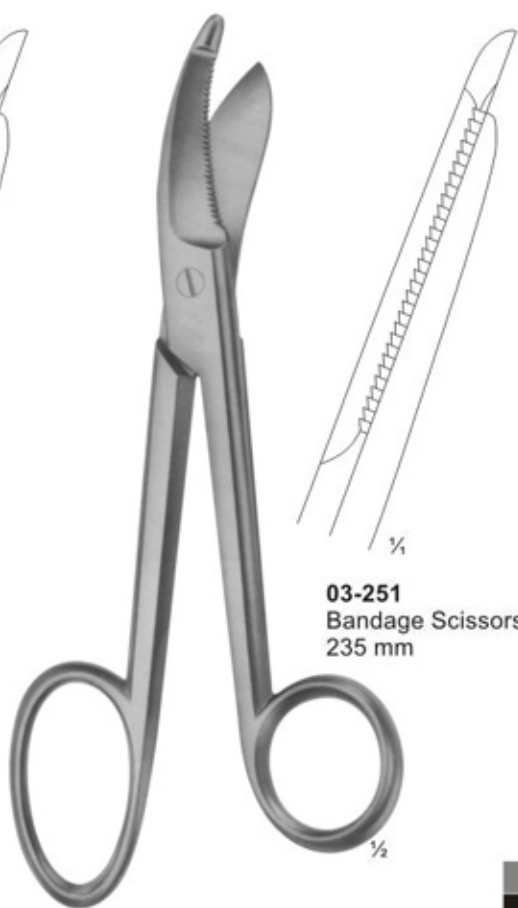

03-251
Bandage Scissors
235 mm

Forceps for grasping tissue, tumors etc.

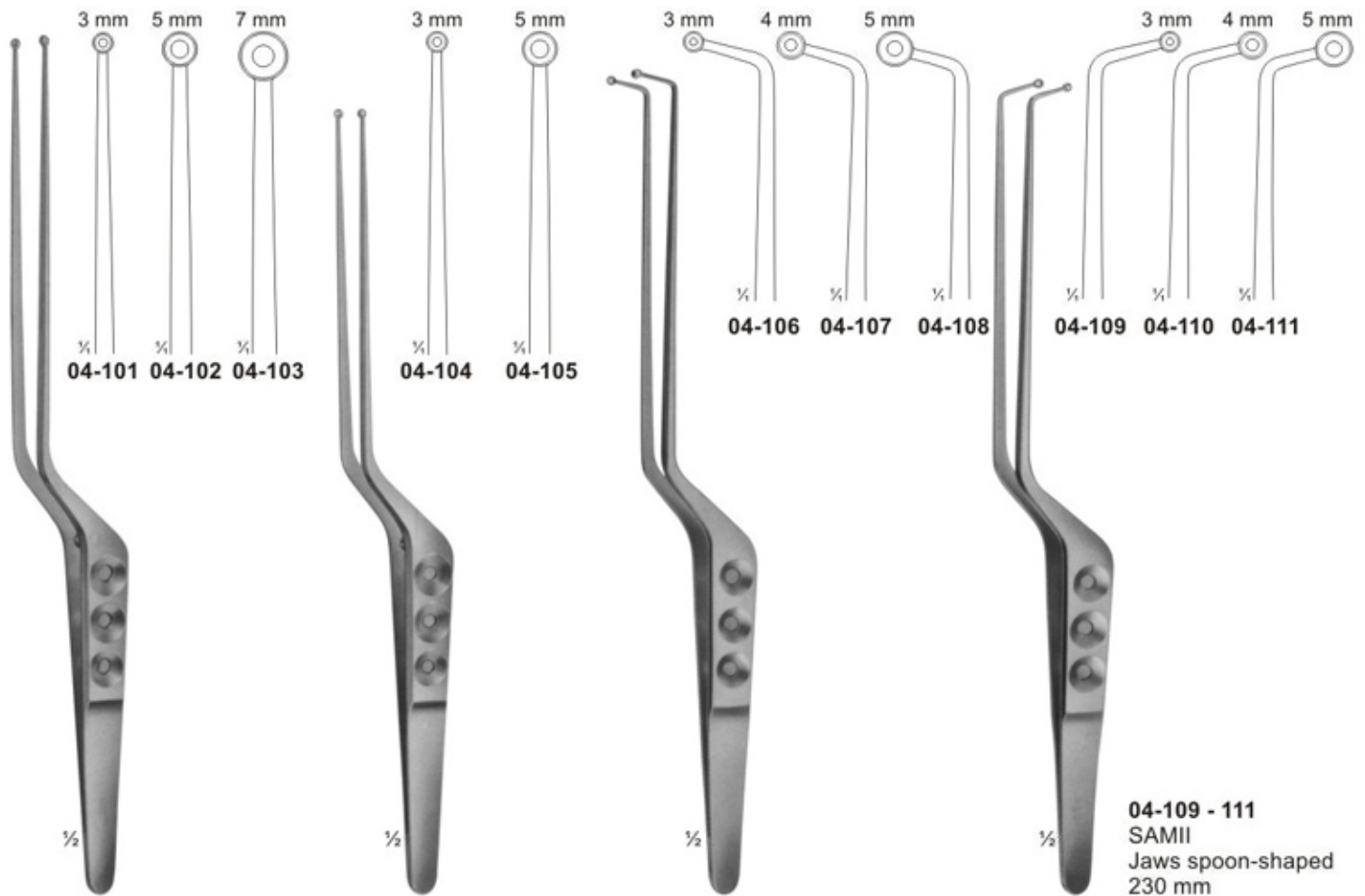

04-101 - 103
YASARGIL-SAMII
Jaws spoon-shaped
240 mm

04-104 - 105
YASARGIL
Jaws spoon-shaped
220 mm

04-106 - 108
SAMII
Jaws spoon-shaped
230 mm

04-109 - 111
SAMII
Jaws spoon-shaped
230 mm

04-112
HUNT
Tumor-and
vessel forceps
200 mm

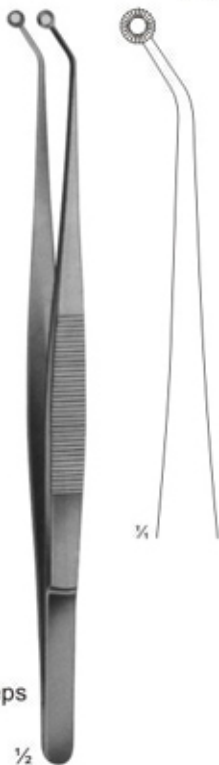

04-113
HUNT
Tumor-and
vessel forceps
200 mm



04-114
YASARGIL
Tumor-and
vessel forceps
200 mm



Delicate Dissecting, Microscopic, Sterilizing Forceps



04-115
THORPE
Corneal forceps
120 mm

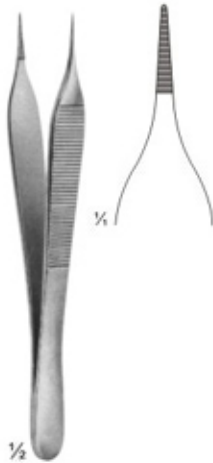

04-116
MICRO-ADSON
120 mm

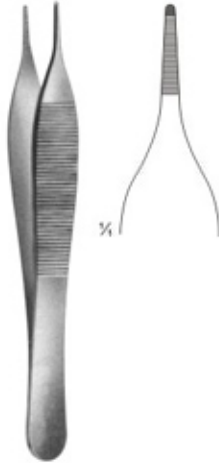

04-117
ADSON
120 mm



04-118
MICRO-ADSON
150 mm



04-119 - 121
100 mm



04-119



04-120



04-121

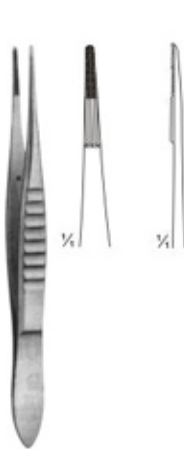

04-122
BONACCOLTO
110 mm

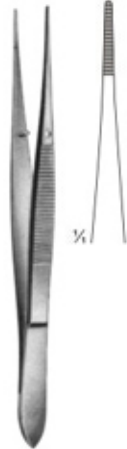

04-123
115 mm



04-124 - 133

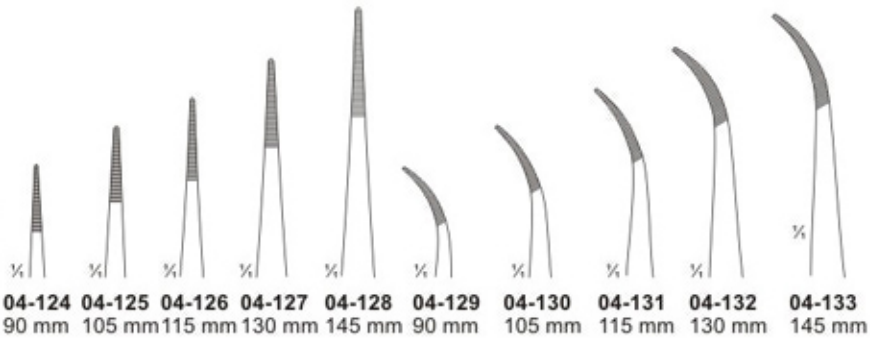

04-124 90 mm **04-125** 105 mm **04-126** 115 mm **04-127** 130 mm **04-128** 145 mm **04-129** 90 mm **04-130** 105 mm **04-131** 115 mm **04-132** 130 mm **04-133** 145 mm



04-134
100 mm



04-135
100 mm



04-136
100 mm

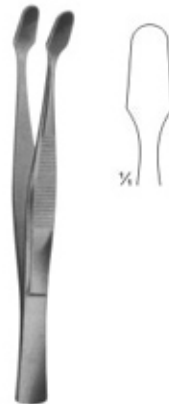

04-137
KUHNE
Cover glass forceps, 105 mm



04-138
160 mm

Delicate Dissecting Forceps

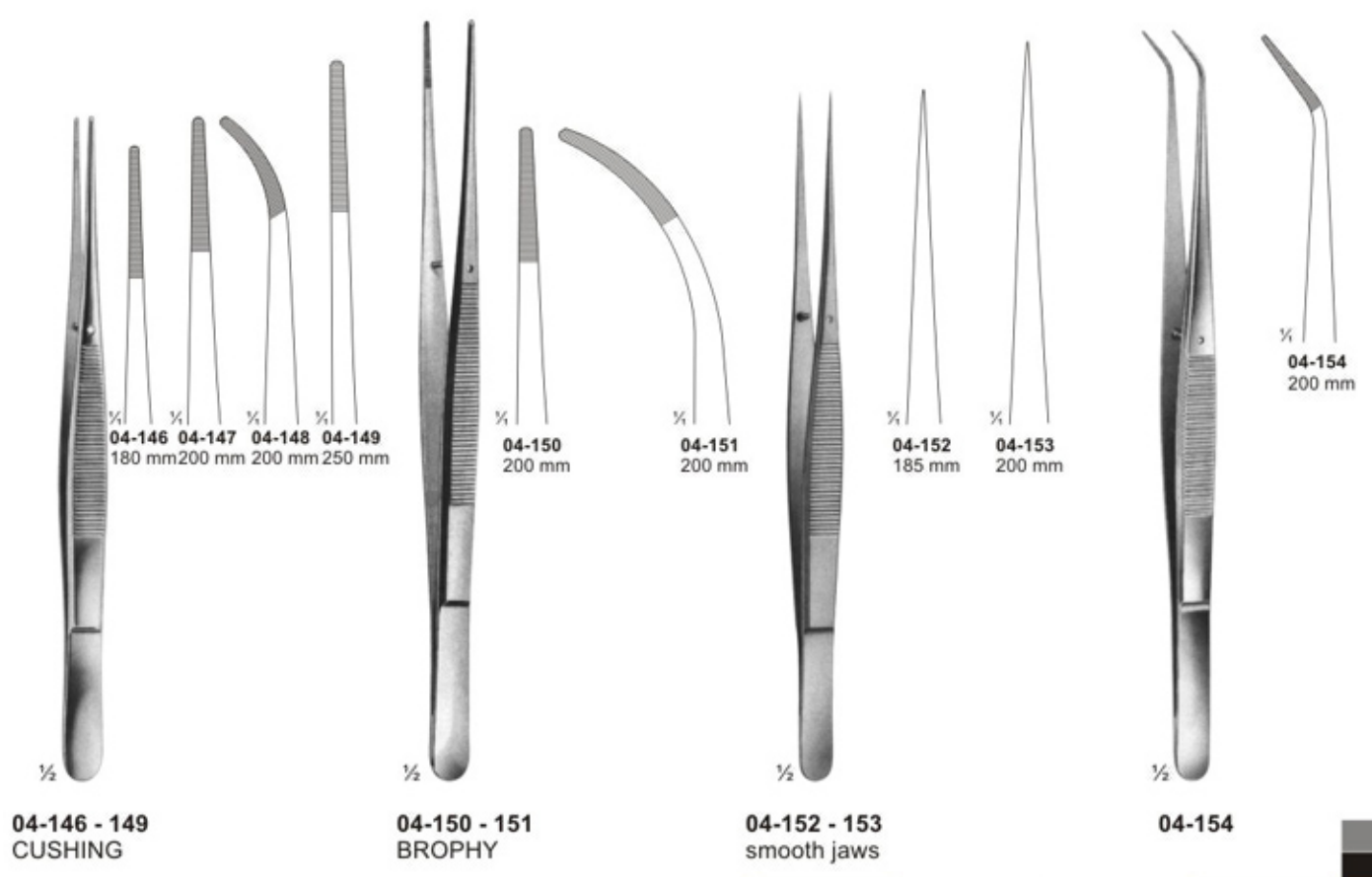
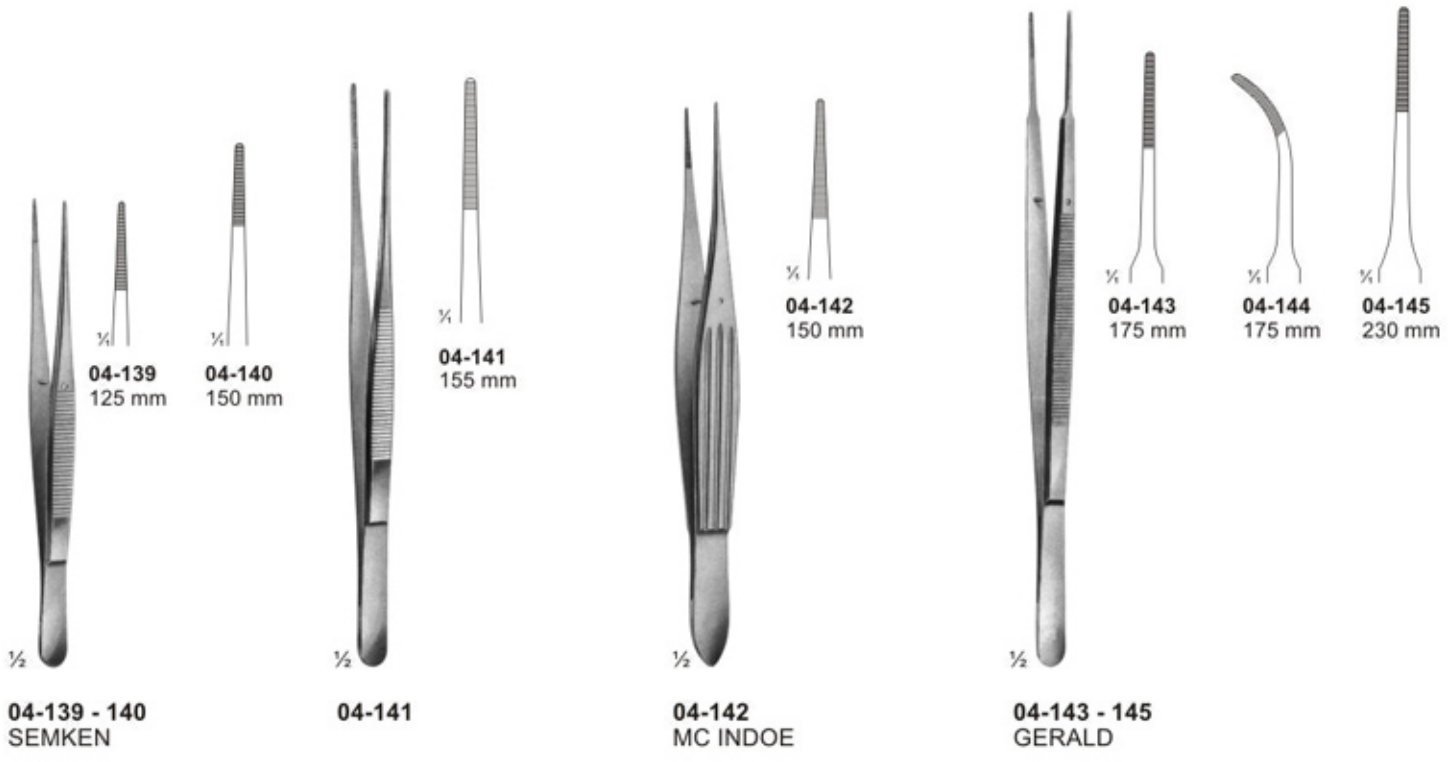

Dissecting Forceps

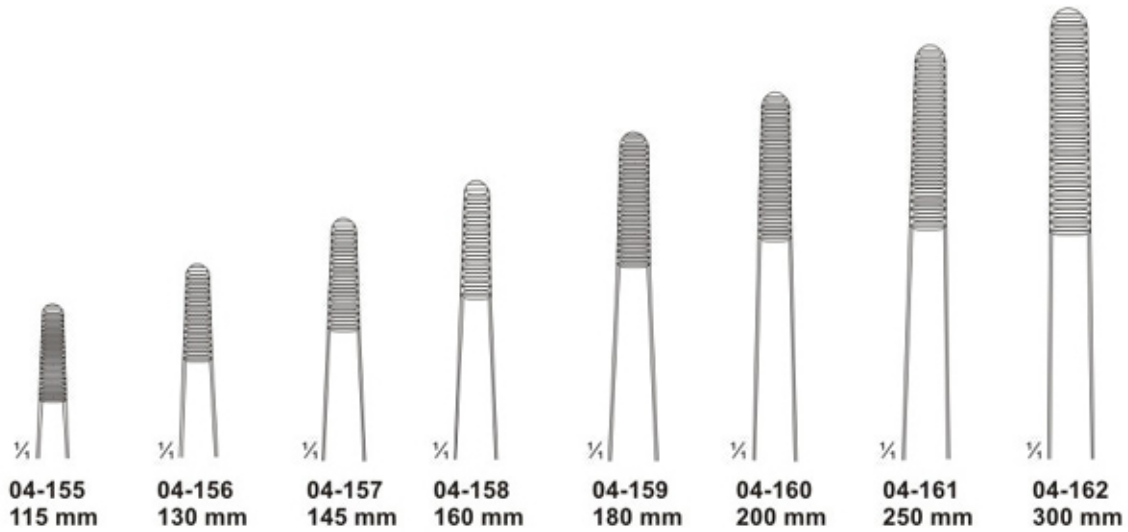

04-155 - 04-162
STANDARD

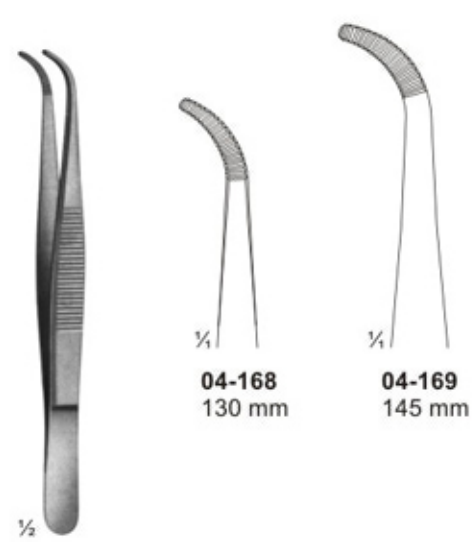
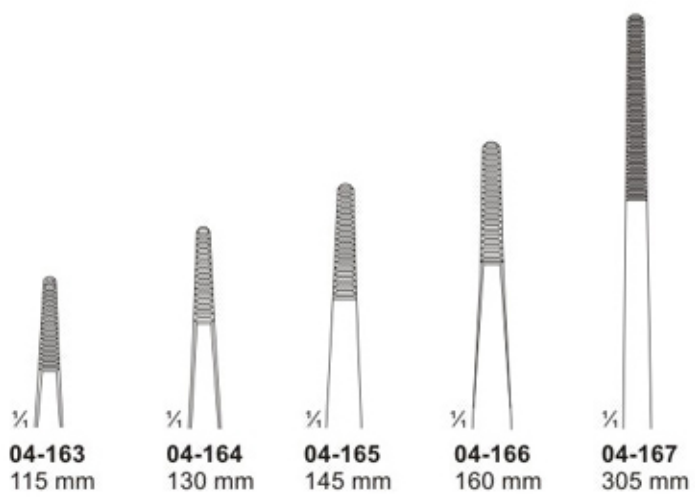

04-163 - 04-167
MEDIUM

04-168 - 04-169
MEDIUM

Forceps

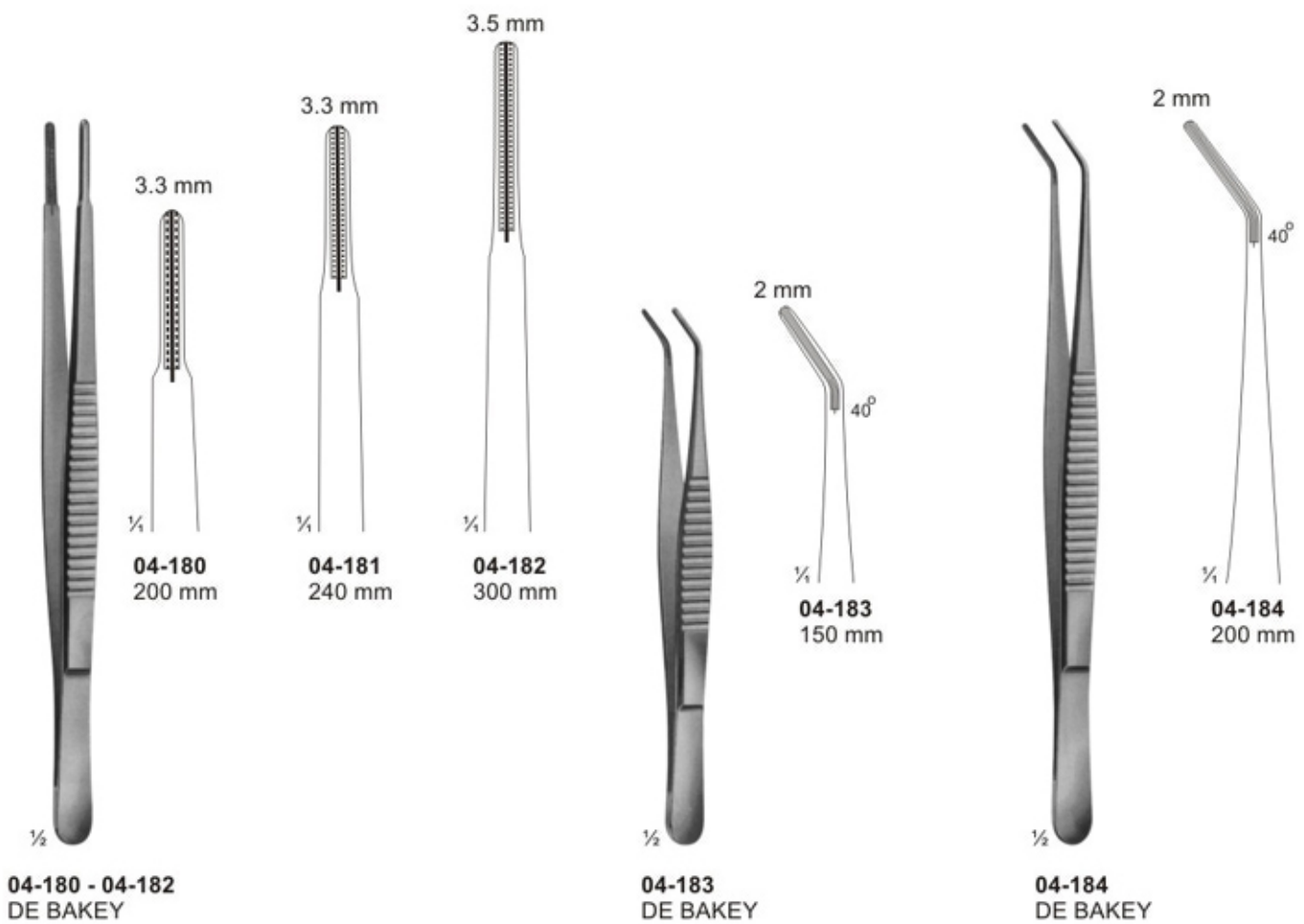
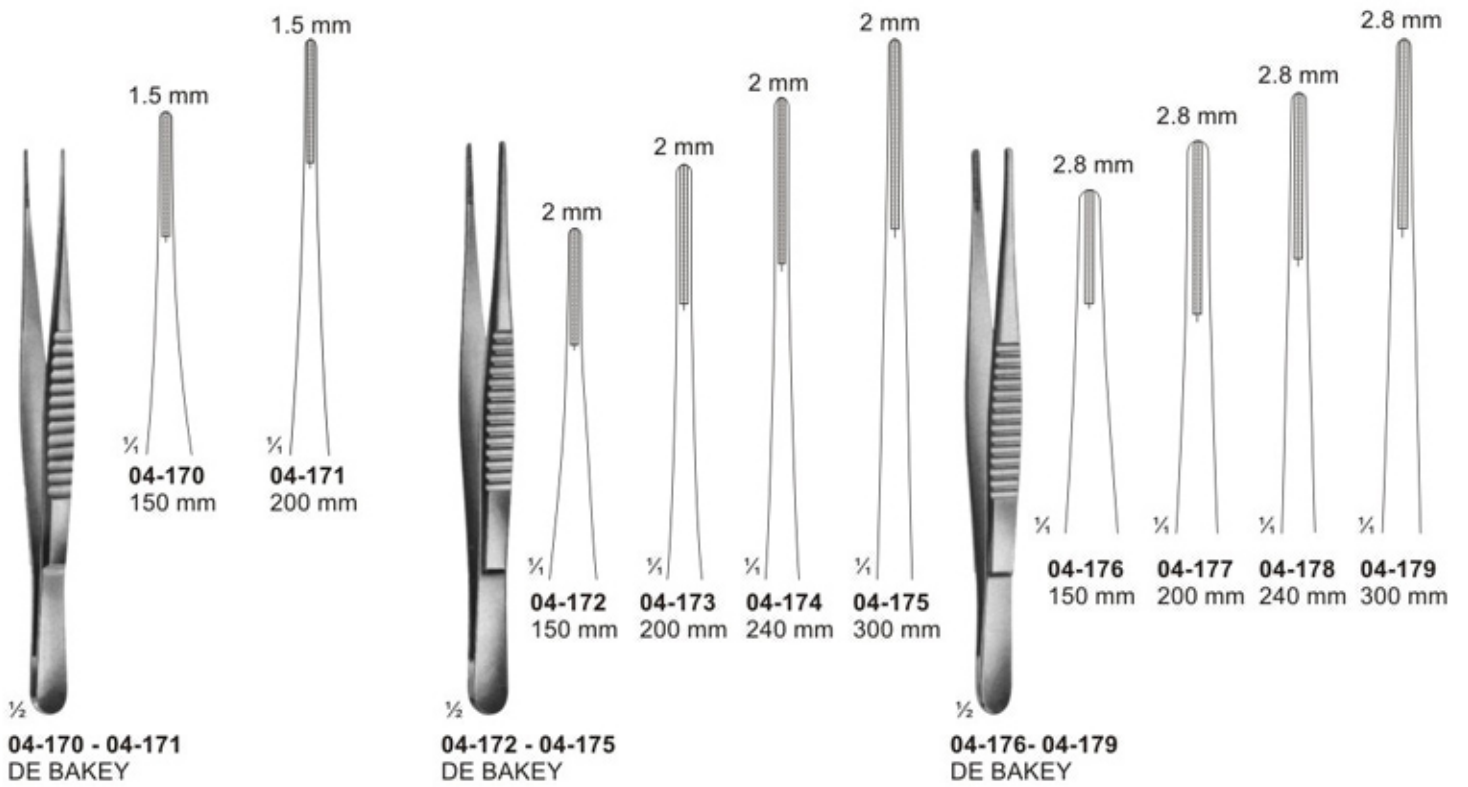

Delicate Tissue Forceps



04-185
BISHOP-HARMON
85 mm

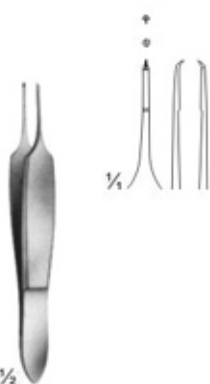

04-186
ST.MARTIN
80 mm

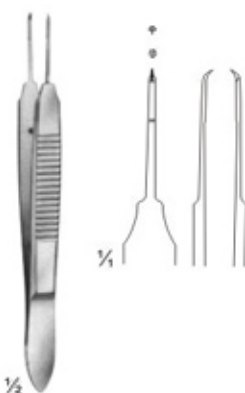

04-187
CASTROVIEJO
teeth 0.9 mm
100 mm

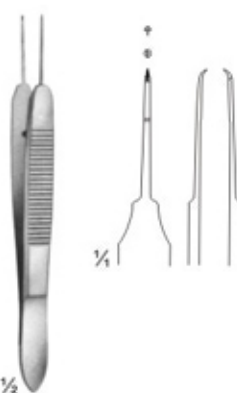

04-188
CASTROVIEJO
teeth 0.5 mm
100 mm

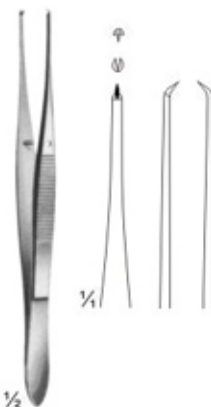

04-189
ELSCHING
110 mm

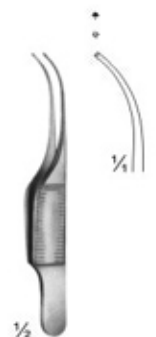

04-190
GILL
75 mm



04-191
GILL - HESS
75 mm

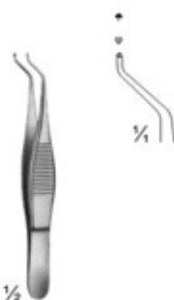

04-192
HESS
70 mm

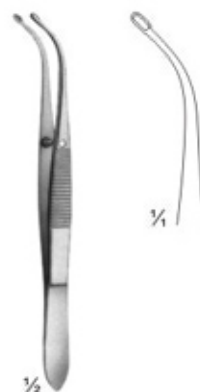

04-193
ARRUGA
100 mm

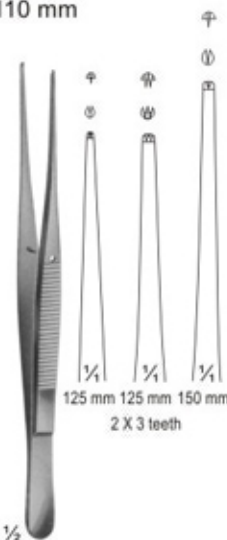

04-194
SEMKEN
125 mm 125 mm 150 mm
2 X 3 teeth

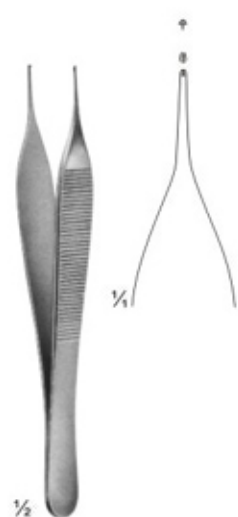

04-195
MICRO-ADSON
120 mm

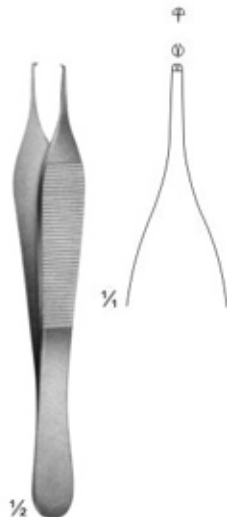

04-196
ADSON
120 mm



04-197
ADSON
120 mm



04-198
ADSON
120 mm

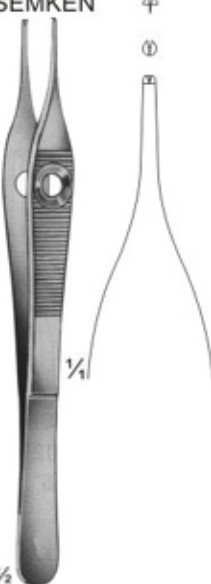

04-199
ADSON
150 mm

Tissue Forceps

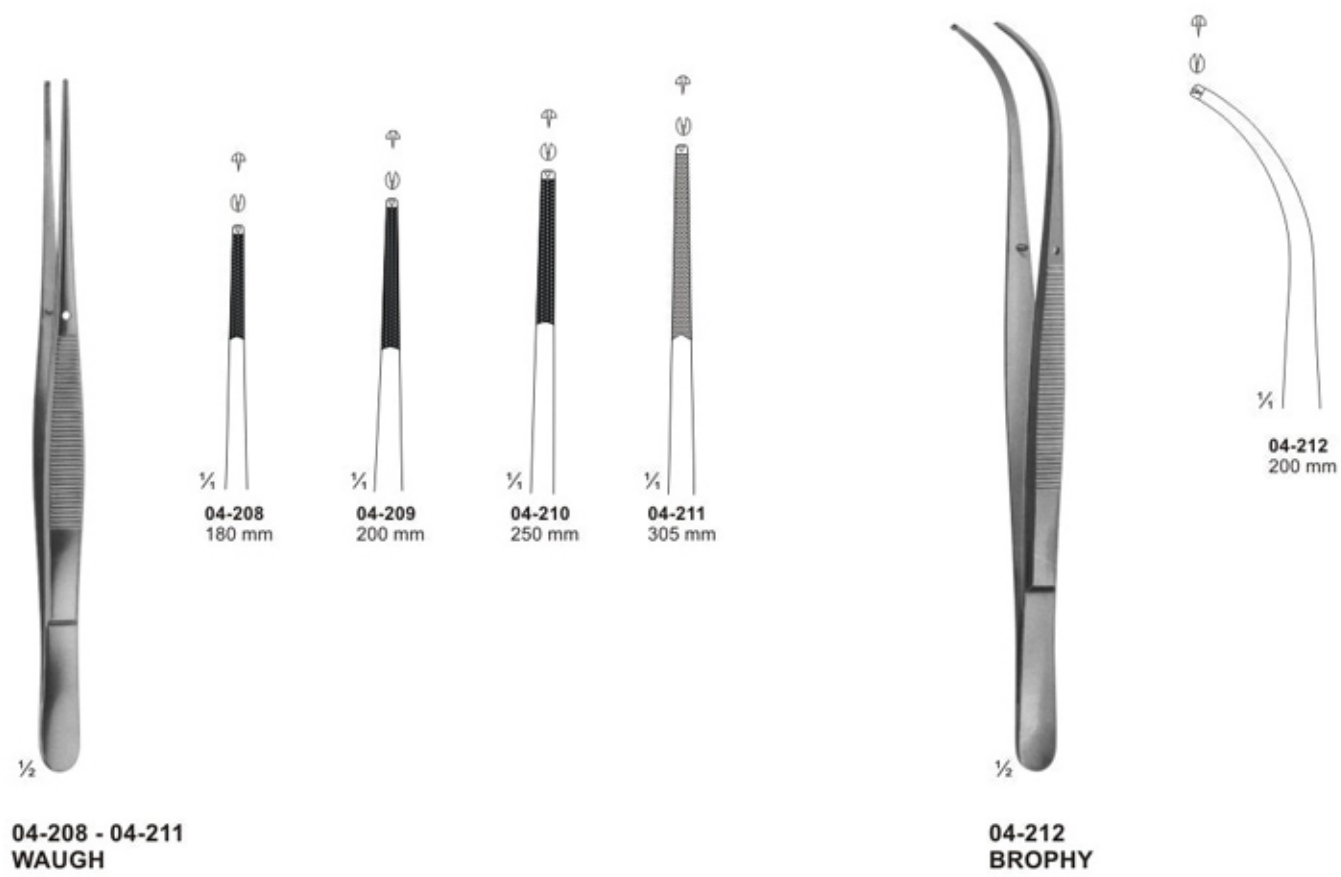
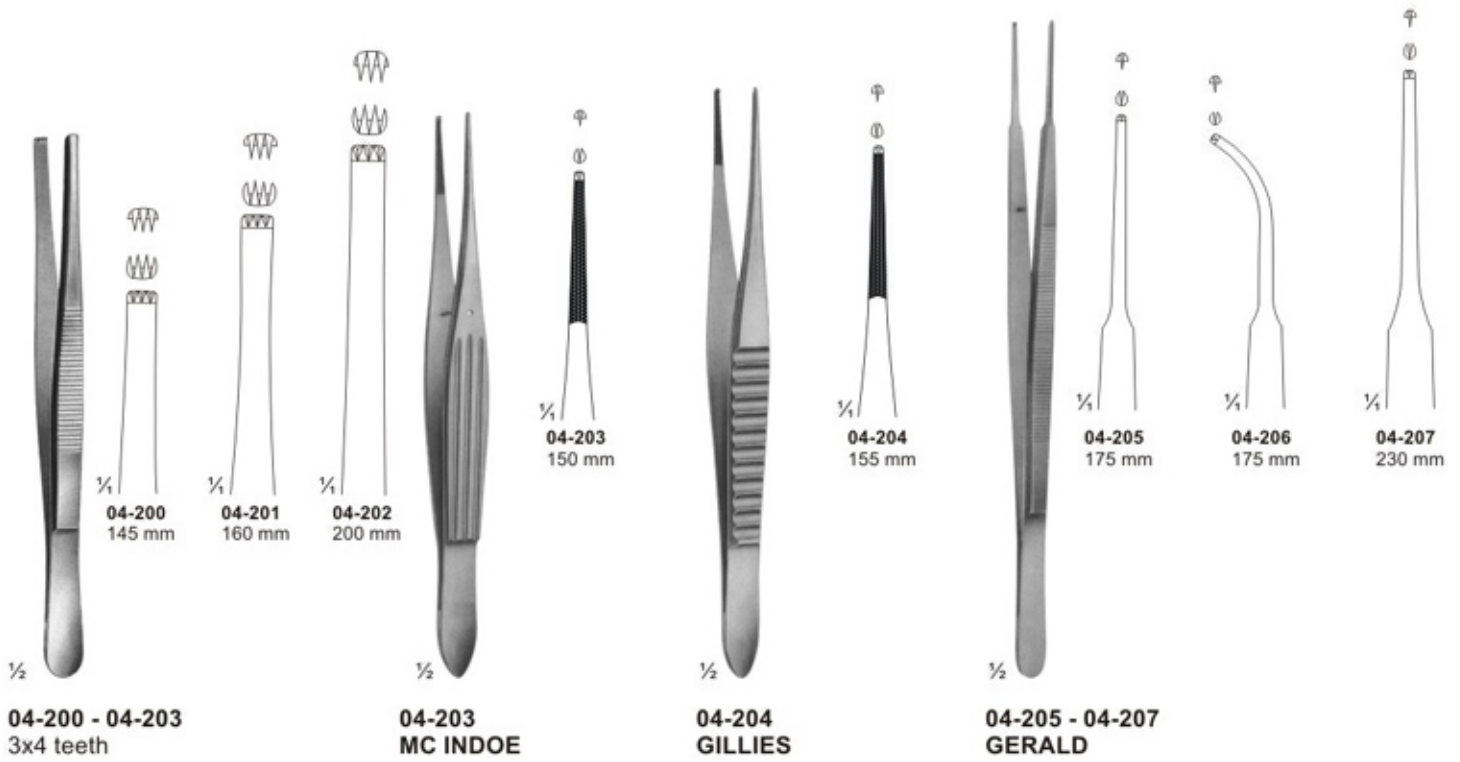

Tissue Forceps

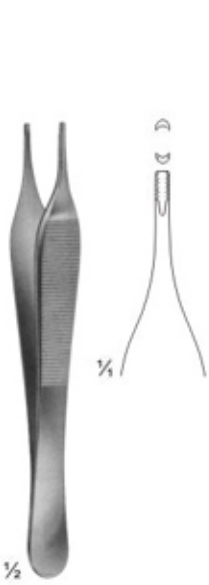

04-213
ADSON - BROWN
 Non-traumatic
 120 mm

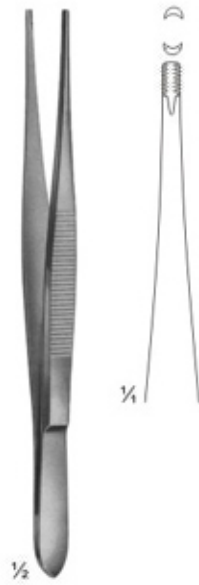

04-214
BROWN
 120 mm



04-215
GRAEFE
 110 mm



04-216
GRAEFE
 With Catch
 110 mm

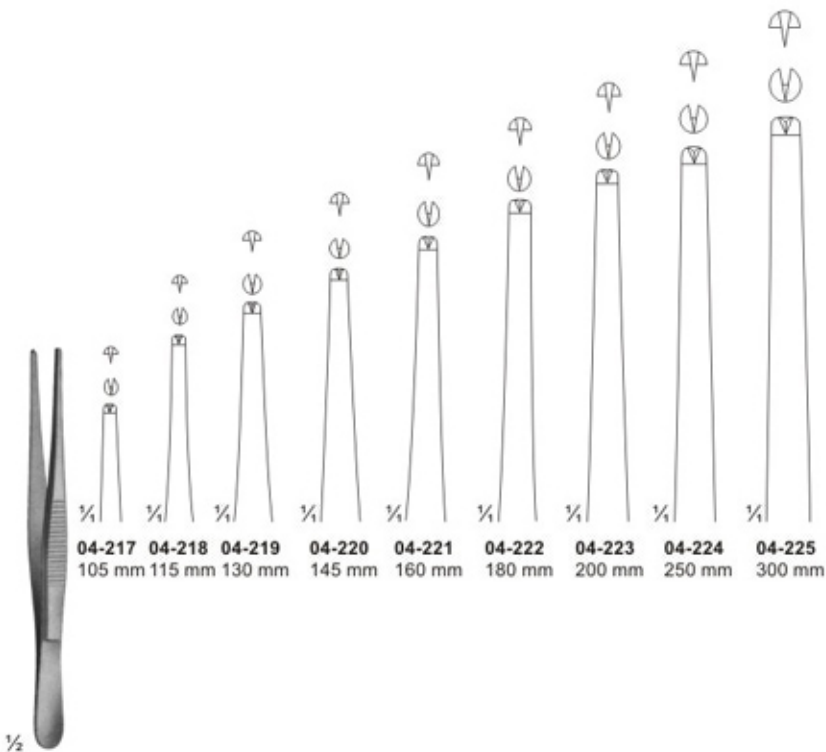

04-217 - 04-225
STANDARD

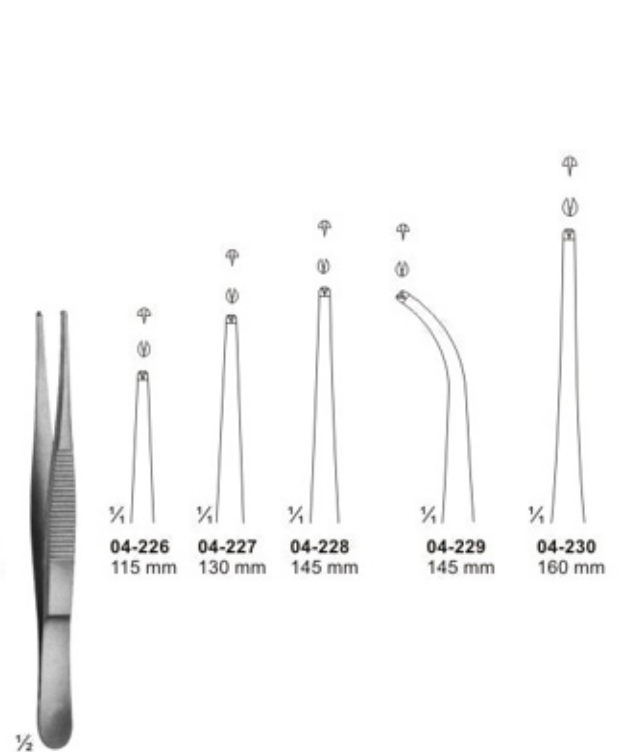

04-226 - 04-230
GRAEFE
 110 mm

Forceps, Bayonet - Shaped

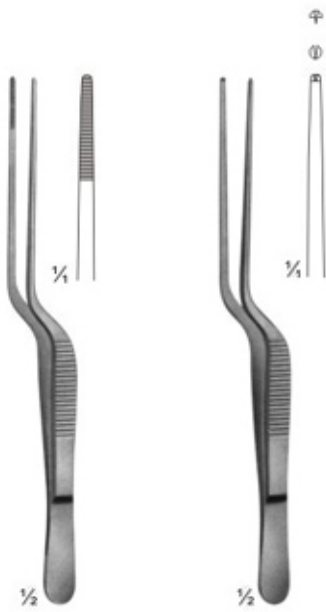

04-231
LUCAE
140 mm



04-232
LUCAE
1x2 teeth
140 mm



04-233
COTTLE
Forceps with
jaws toothed
and serrated
140 mm



04-234
JANSEN
160 mm



04-235
GRUENWALD
200 mm



04-236
1x2 teeth
200 mm

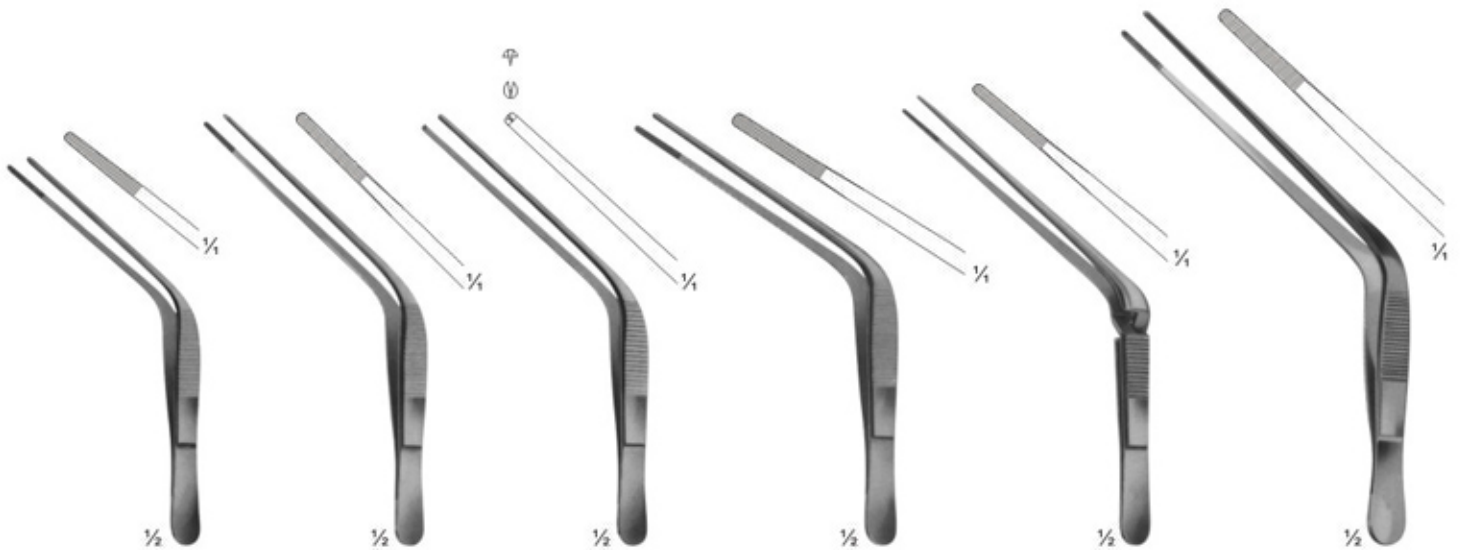

04-237
TROELTSCH
100 mm

04-238
TROELTSCH
115 mm

04-239
TROELTSCH
1X2 teeth
115 mm

04-240
WILDE
115 mm

04-241
TROELTSCH
Cross action
120 mm

04-242
TROELTSCH
140 mm

Tissue Forceps, Lung Dissecting Forceps

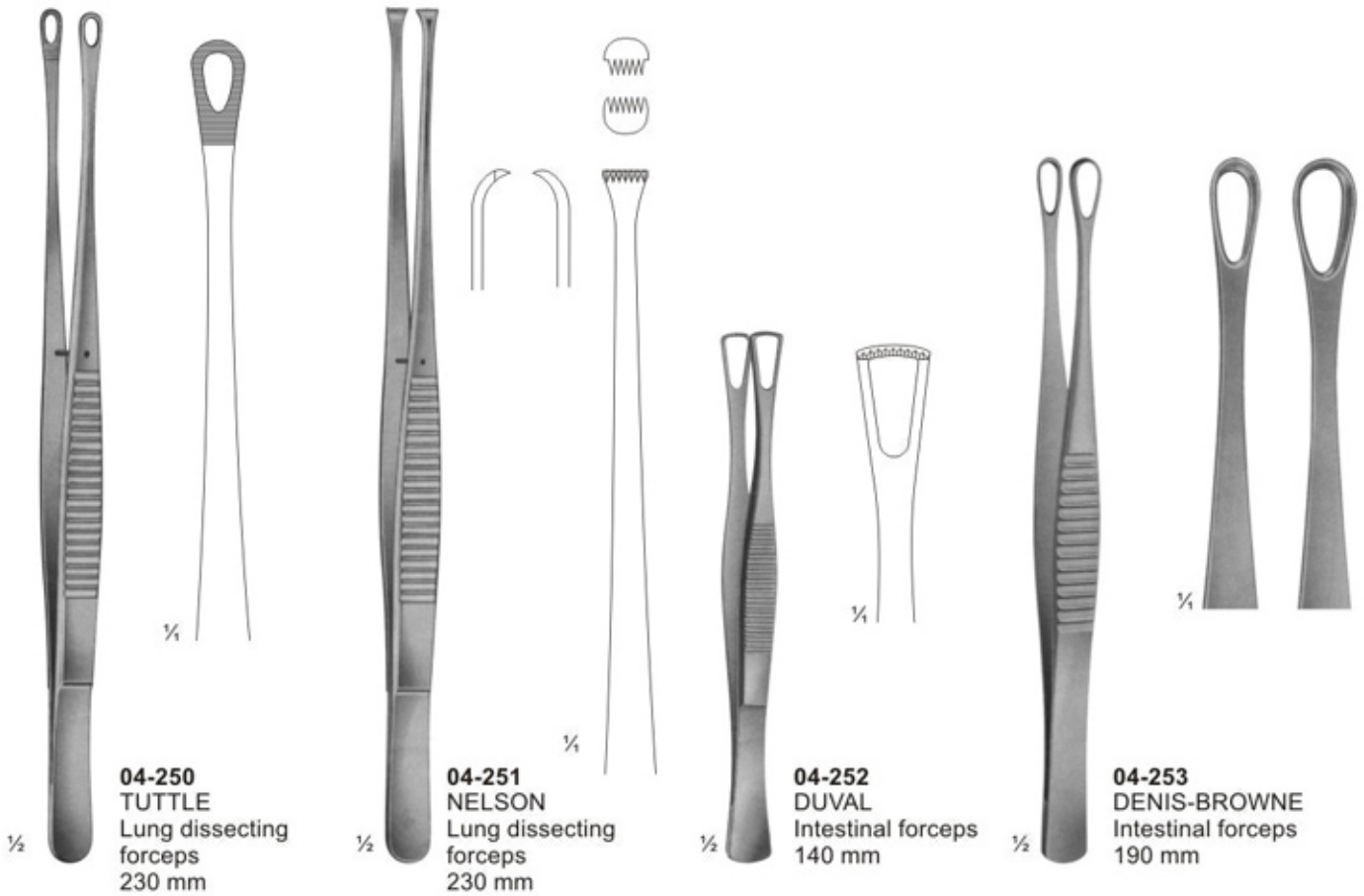
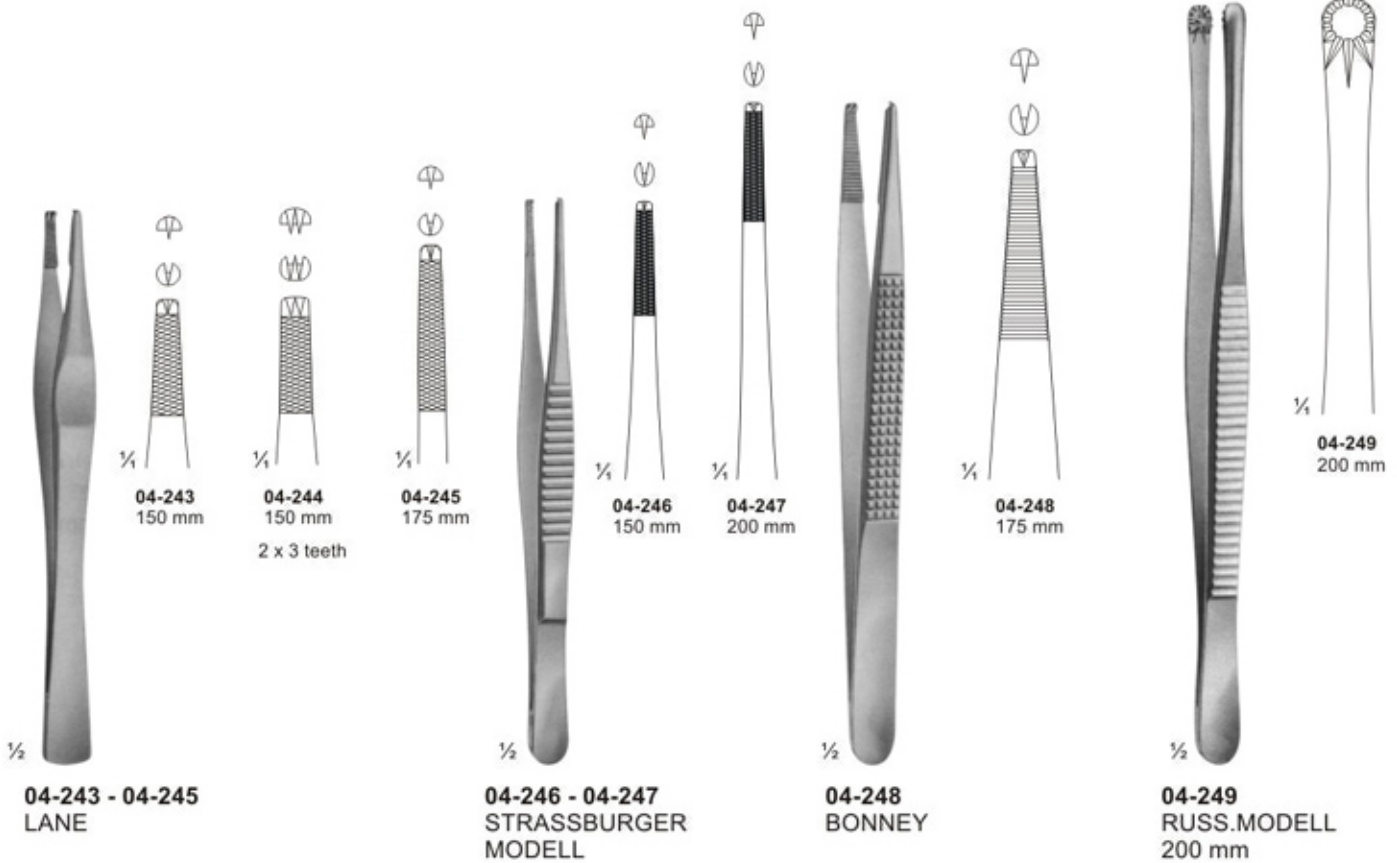

Splinter and Cilia Forceps

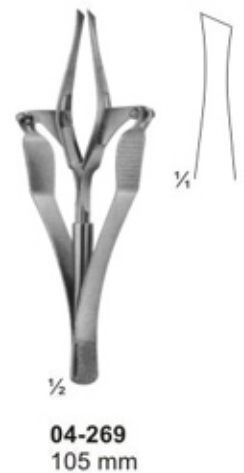
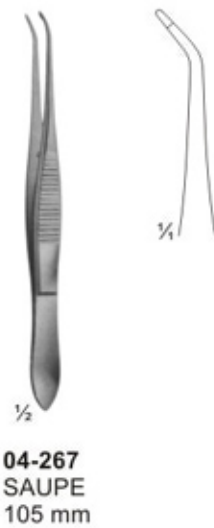
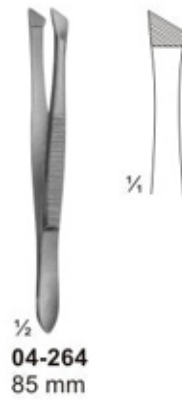
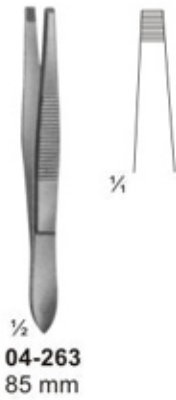
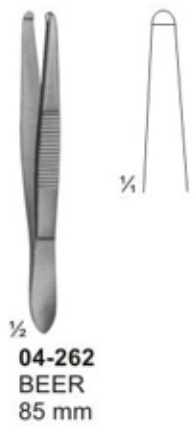
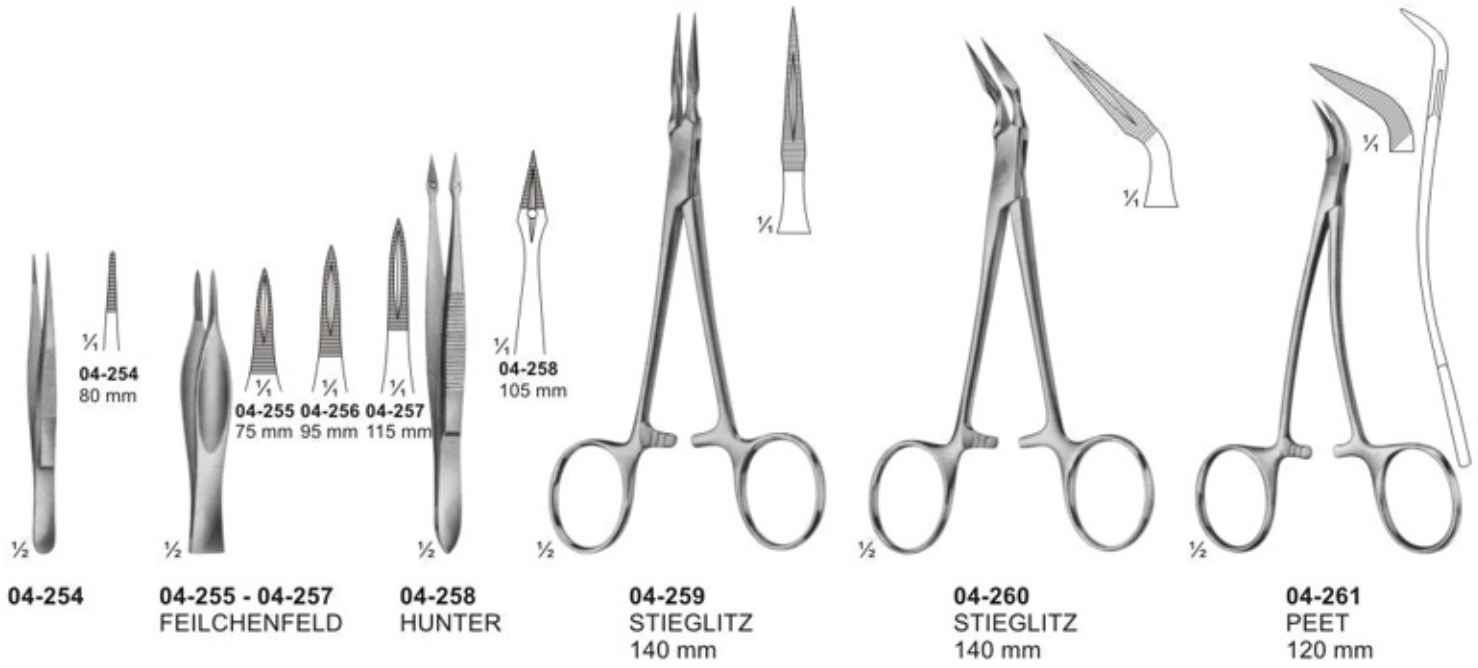

Sponge and Dressing Forceps



04-270
BRYANT
130 mm

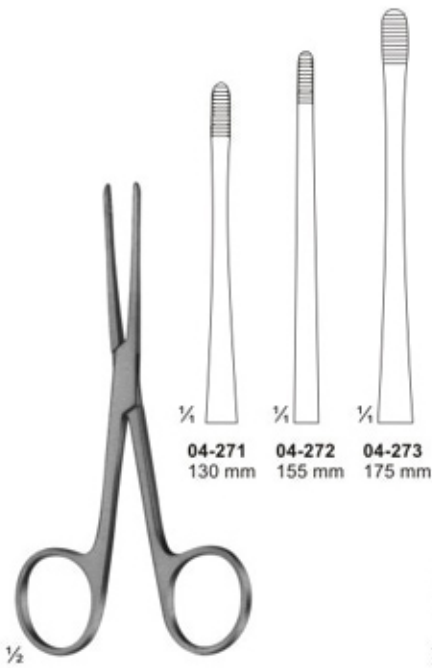

04-271 - 04-273
LISTER
Sinus forceps

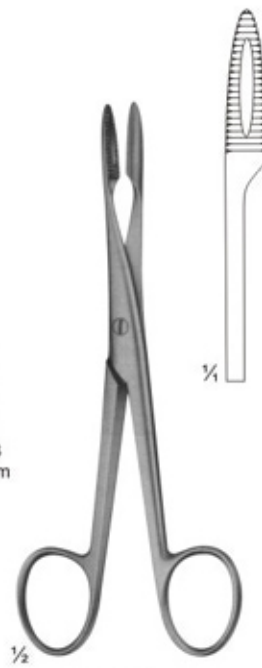

04-274
without ratchet
145 mm

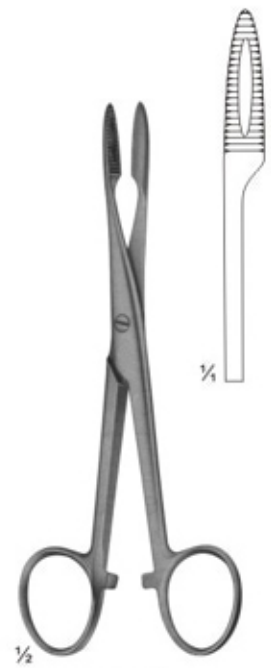

04-275
with ratchet
145 mm

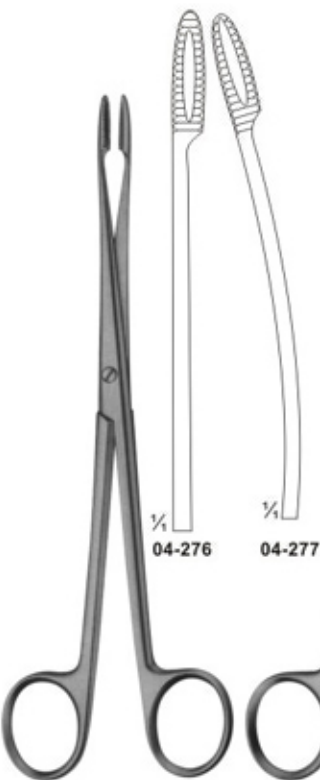

04-276 - 04-277
GROSS
without ratchet
180 mm



04-278 - 04-279
GROSS
with ratchet
180 mm

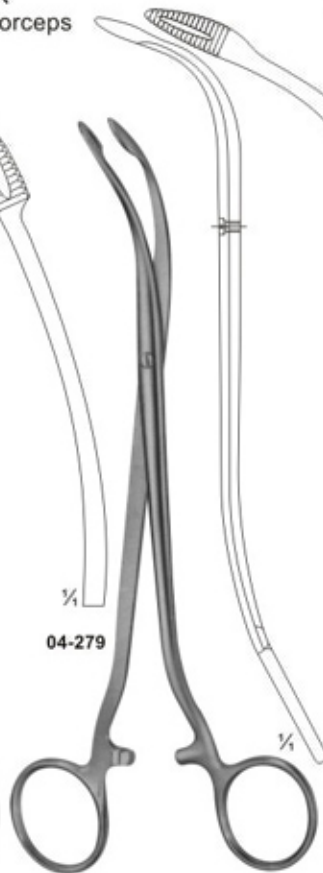

04-280
DUPLAY
190 mm

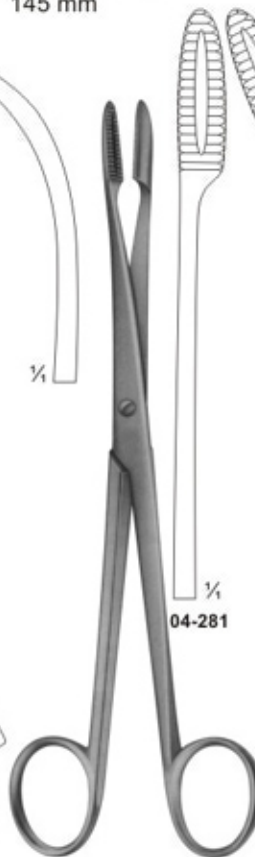

04-281 - 04-282
GROSS
without ratchet
200 mm

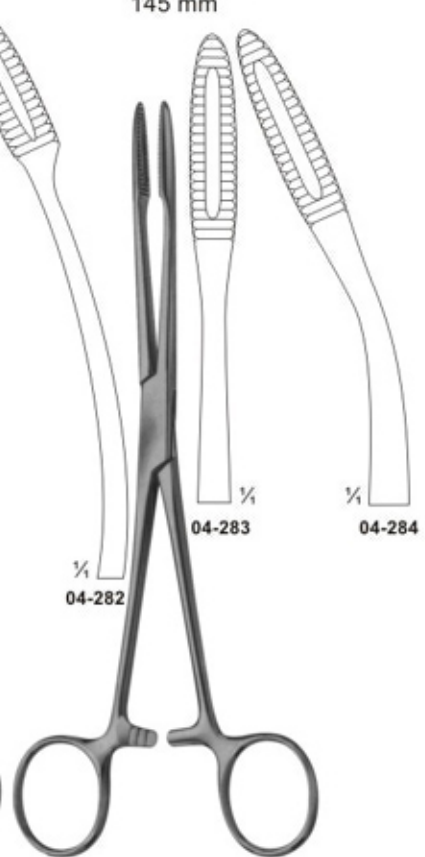

04-283 - 04-284
GROSS
200 mm

Dressing-, Sponge holding-, Organ- and Tissue Grasping Forceps

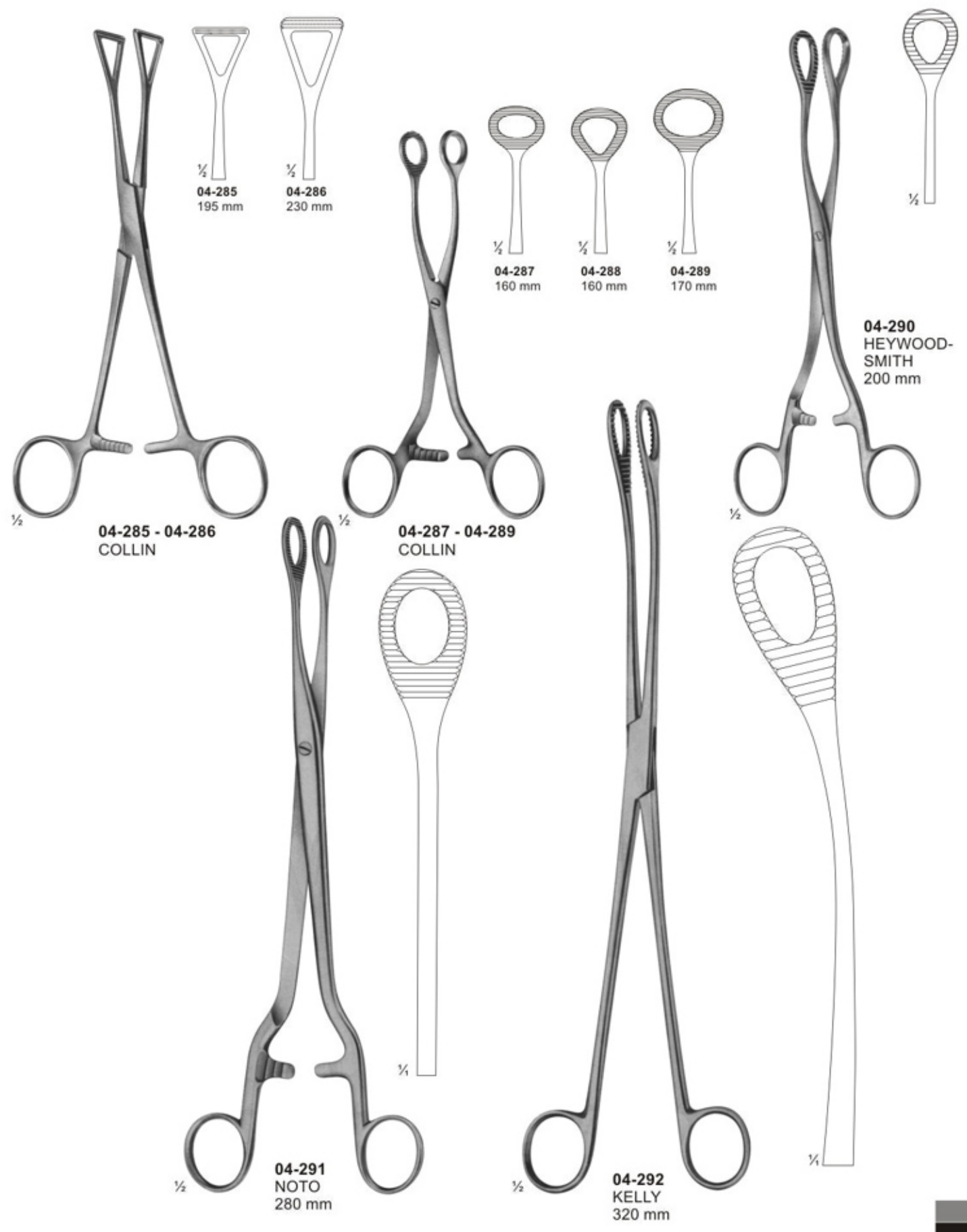

Dressing, Sponge holding, Organ and Tissue Grasping Forceps

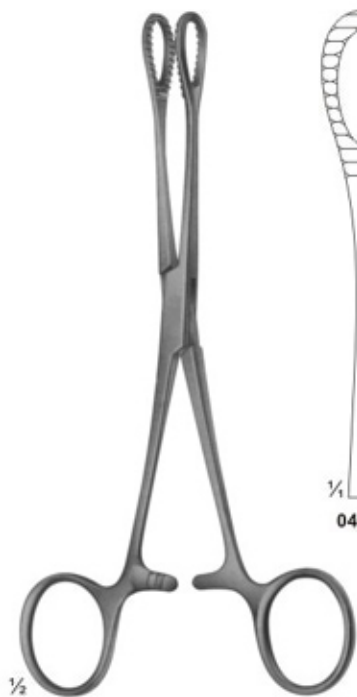

04-293 - 04-294
FOERSTER-BALLENGER
180 mm



04-293



04-294



04-295 - 04-296
RAMPLEY



04-295
180 mm



04-296
250 mm



04-297 - 04-300
FOERSTER-BALLENGER
240 mm



04-297
Smooth Jaws



04-298
Smooth Jaws



04-299
Serrated Jaws



04-300
Serrated Jaws

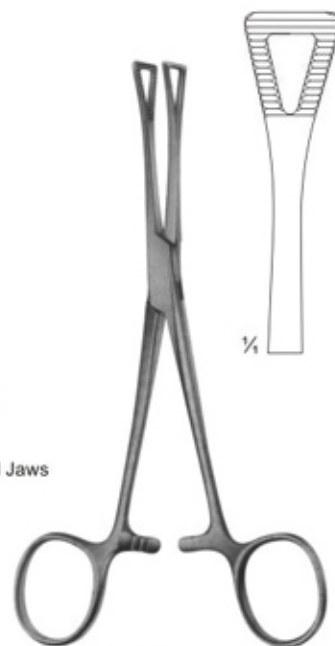

04-301
PENNINGTON
155 mm



04-301

Intestinal Grasping Forceps

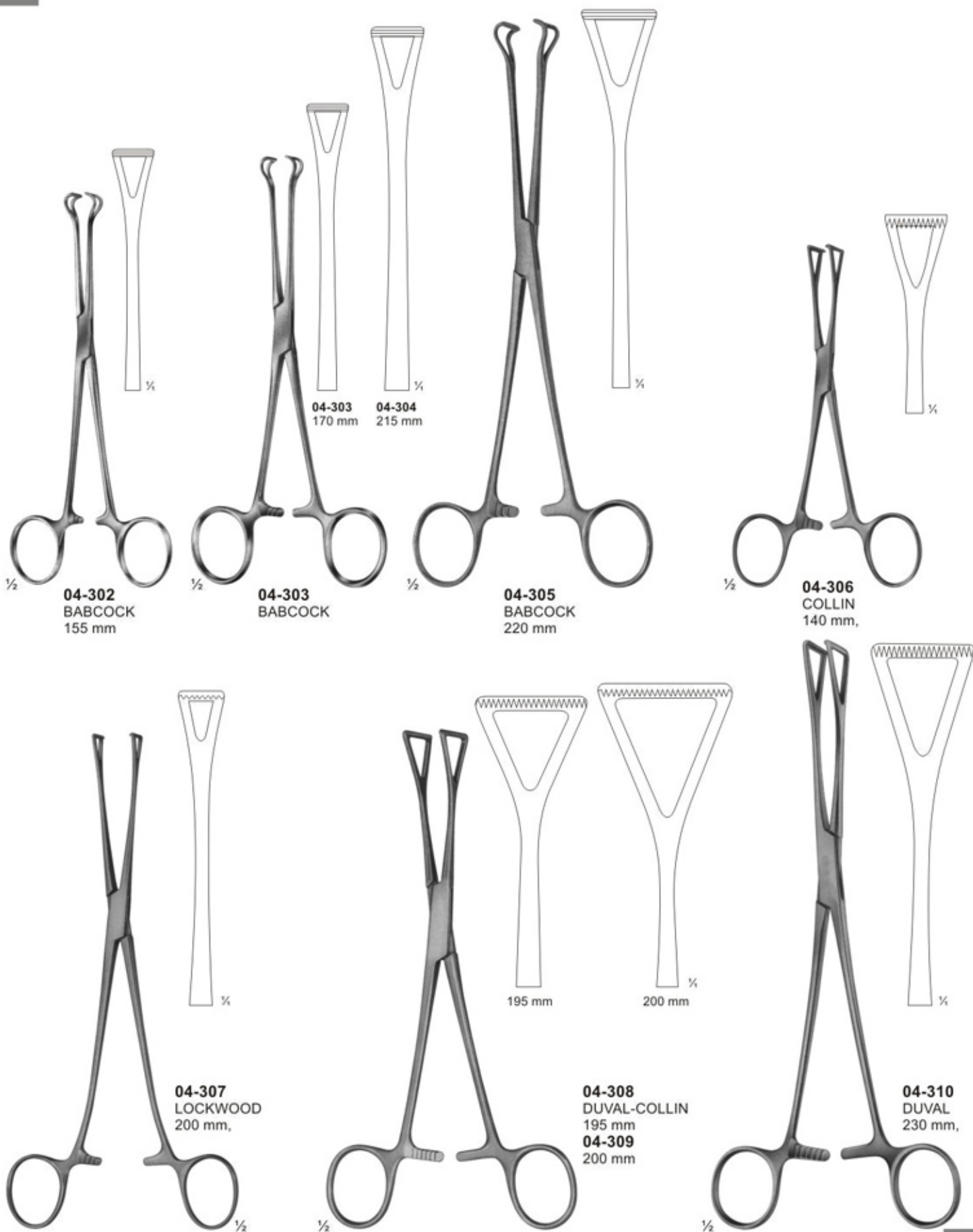

Artery Traction - and Tissue Grasping Forceps

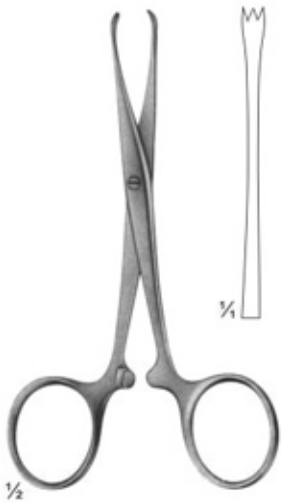

04-311
CHAPUT
 2 x 3 teeth
 125 mm

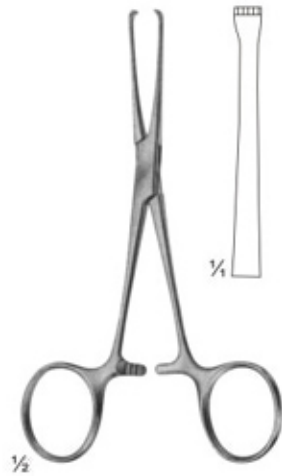

04-312
BABY-ALLIS
 4 x 5 teeth
 130 mm

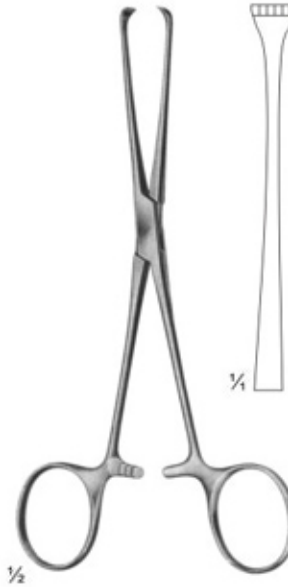

04-313
BOYS-ALLIS
 5 x 6 teeth sharp
 155 mm

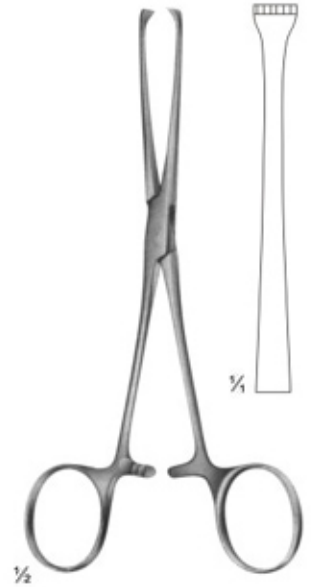

04-314
ALLIS
 5 x 6 teeth
 155 mm



04-315
LAHEY
 155 mm

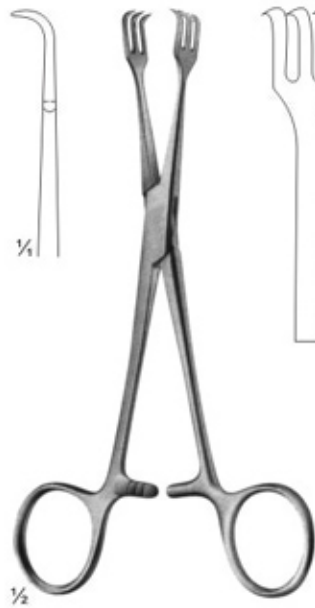

04-316
LAHEY
 155 mm

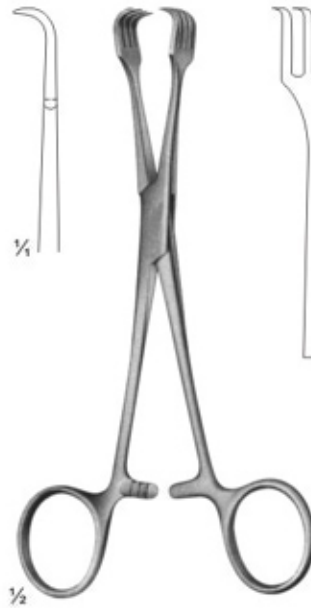

04-317
BRAUN
 155 mm

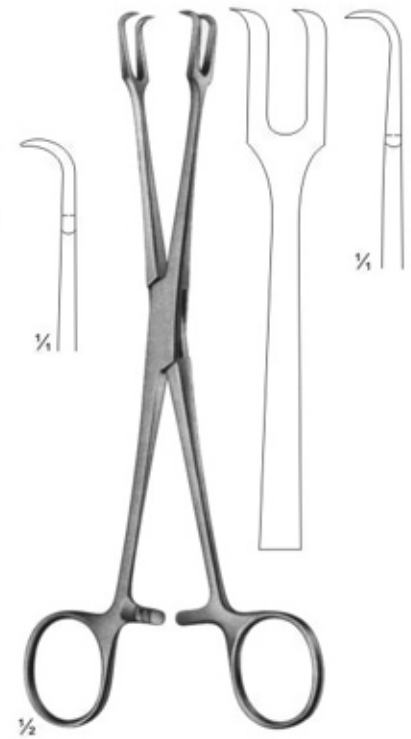

04-318
MUSEUX
 200 mm

Towel Clamps

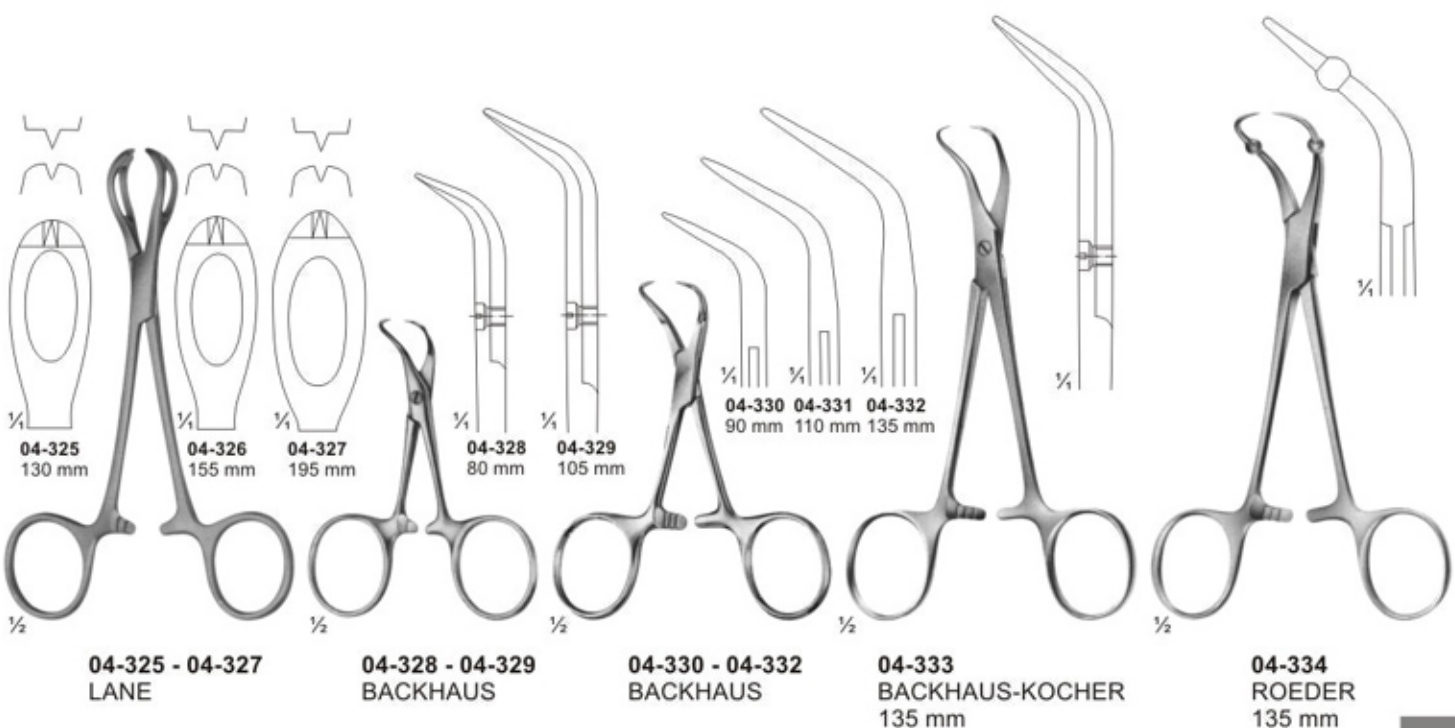
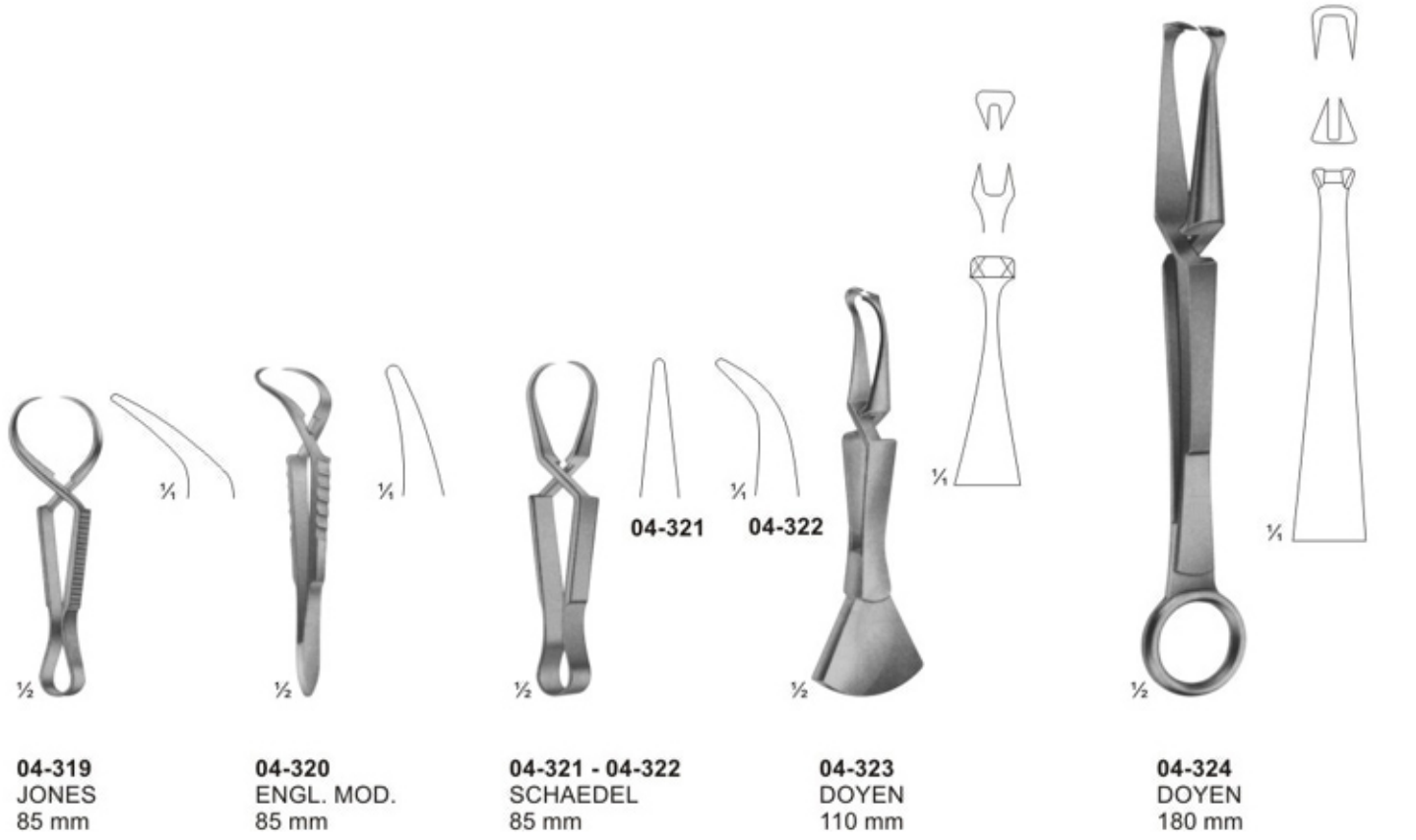

Muller Vessel Clips and Bulldog Clamps

Closing force

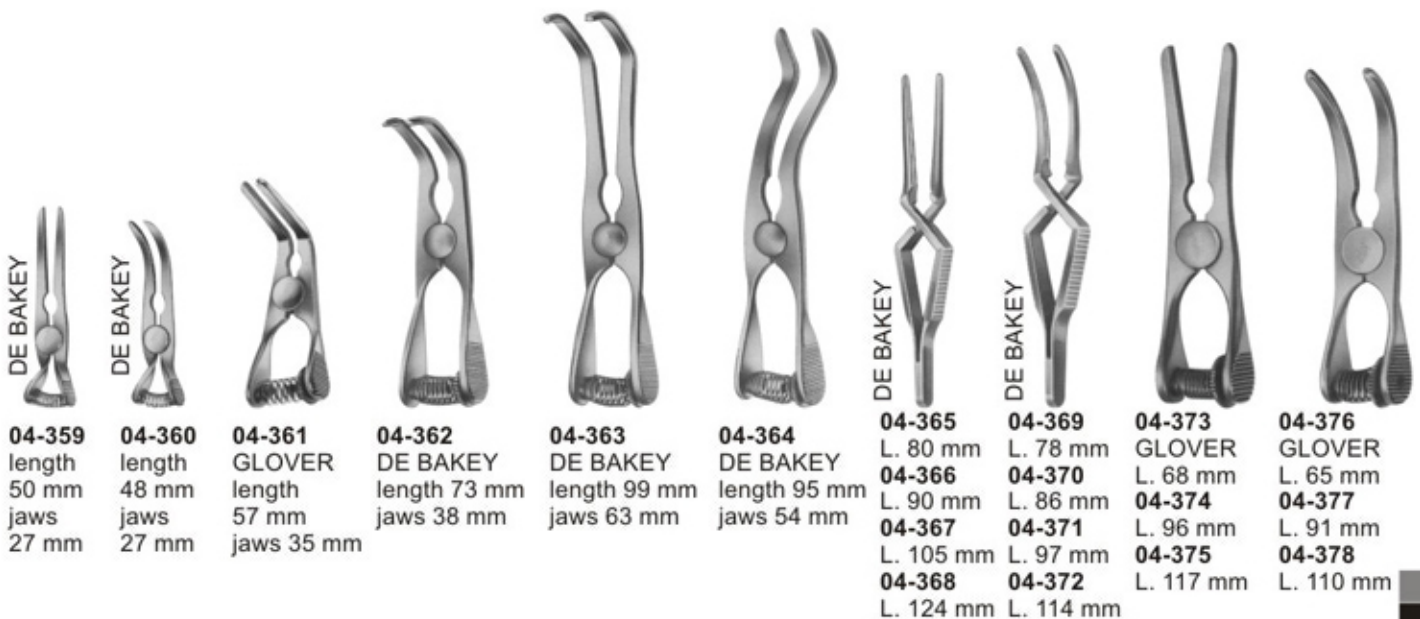
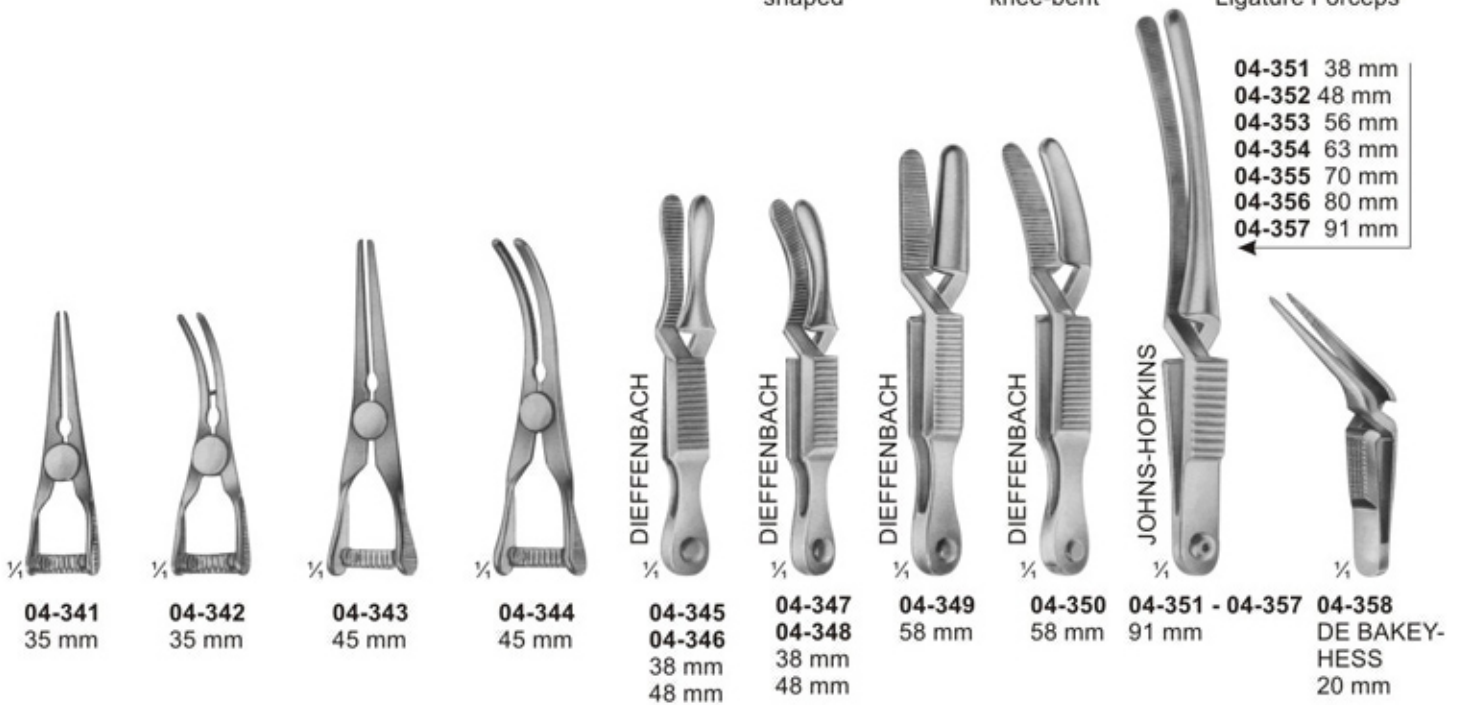
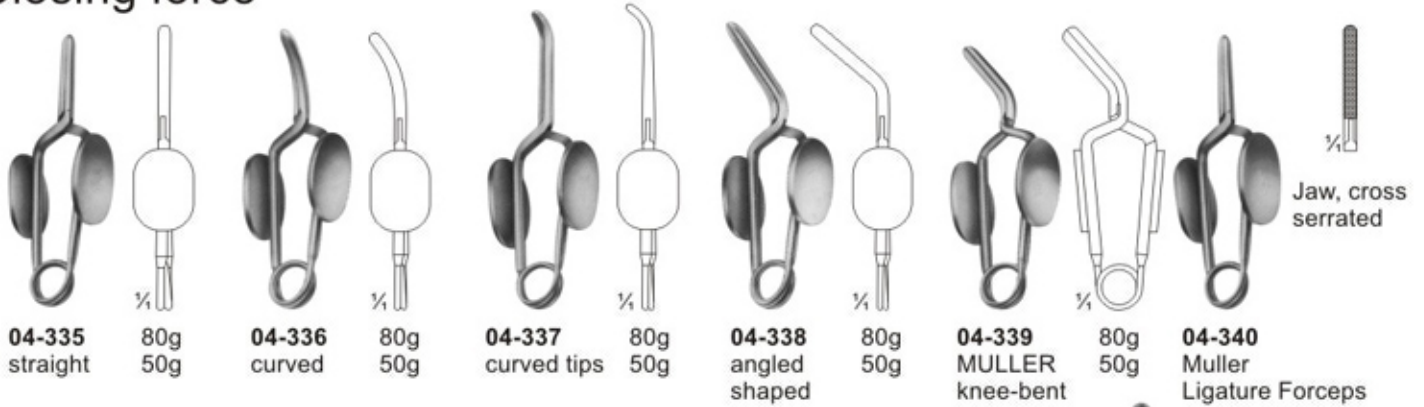

Delicate Haemostatic Forceps

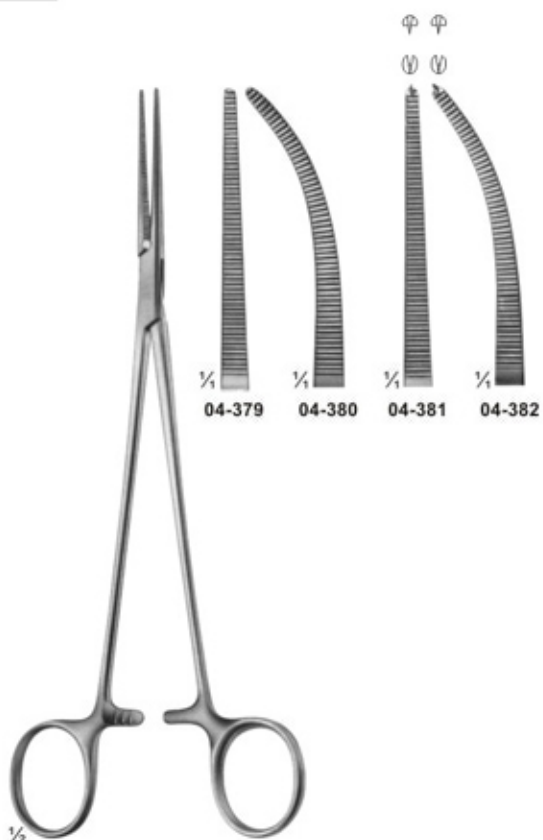

04-379 - 04-382
HALSTED-MOSQUITO
200 mm

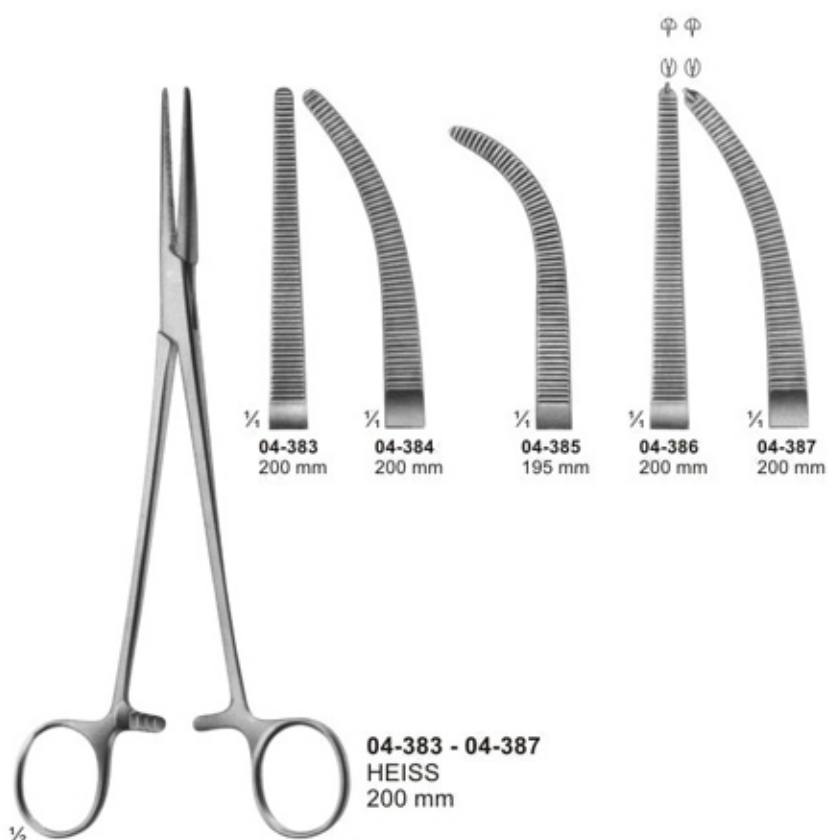

04-383 - 04-387
HEISS
200 mm



04-388 - 04-389
HALSTED
215 mm

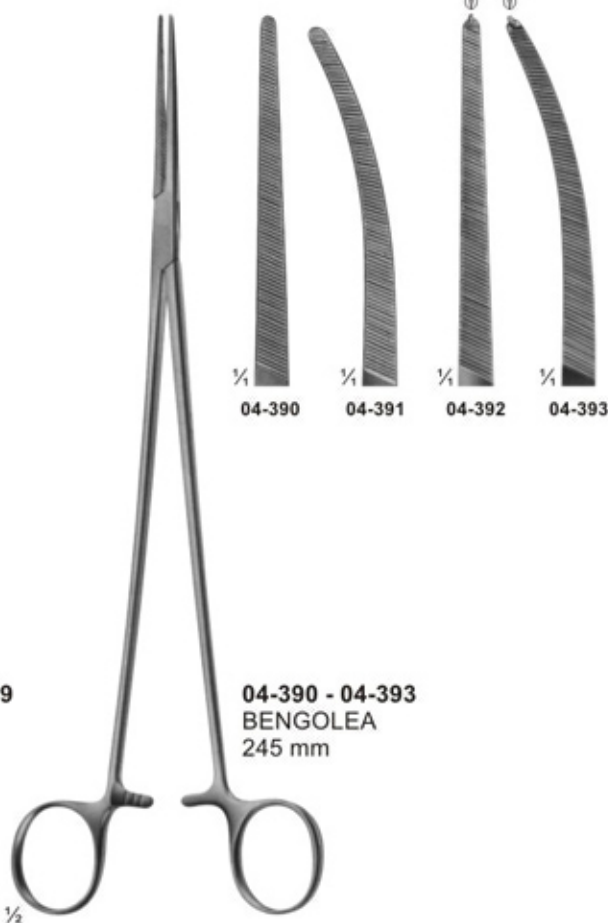

04-390 - 04-393
BENGOLEA
245 mm

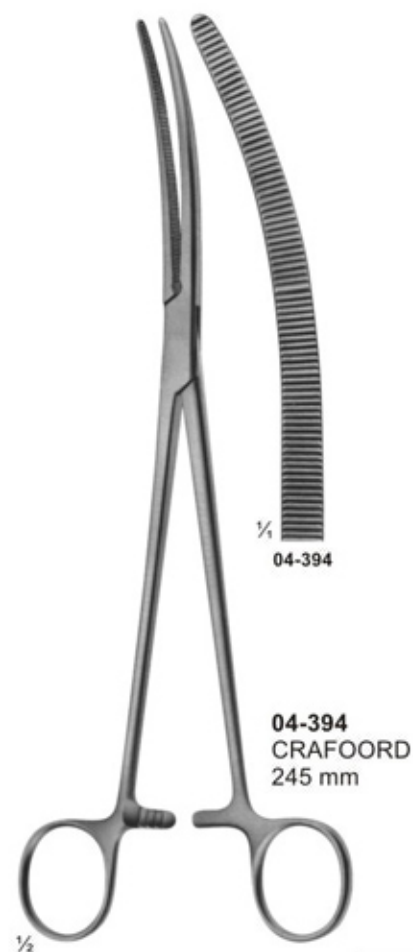

04-394
CRAFOORD
245 mm

Delicate Haemostatic Forceps



04-395
CARREL
85 mm



04-396 - 04-399
BABY-MOSQUITO
(HARTMANN)
100 mm

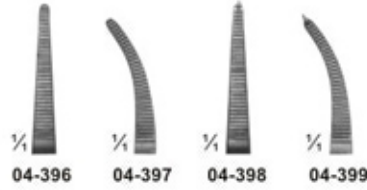

04-400 - 04-403
MICRO-HALSTED
125 mm

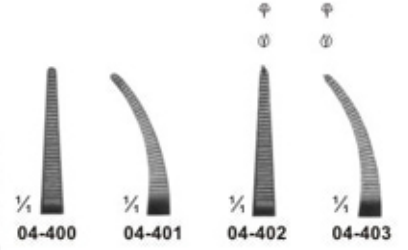

04-404 - 04-407
HALSTED-MOSQUITO
125 mm

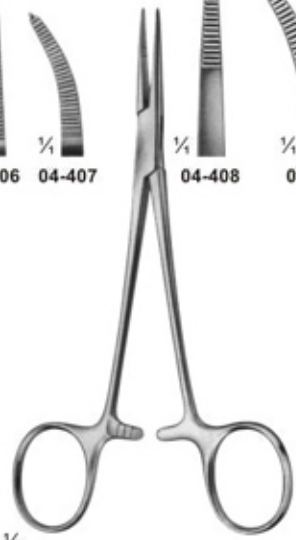
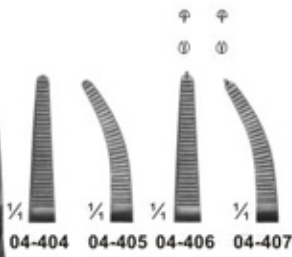

04-408 - 04-409
PROVIDENCE-HOSPITAL
140 mm

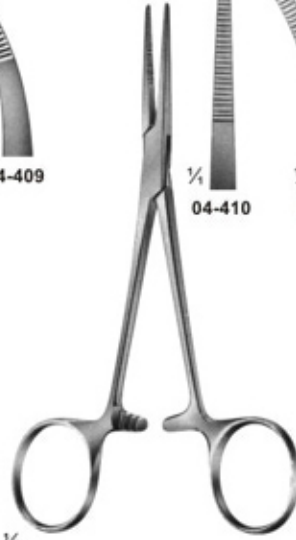
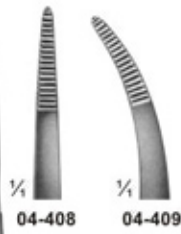

04-410 - 04-411
KELLY
140 mm

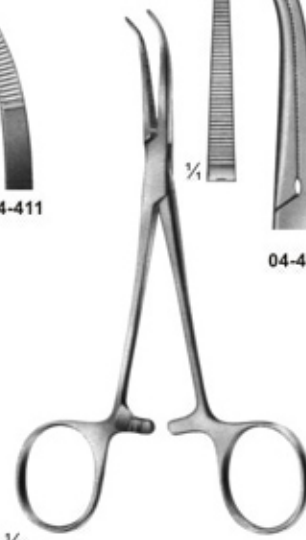
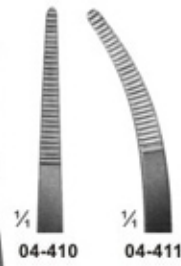

04-412 - 04-413
DANDY
Curved sideways
140 mm

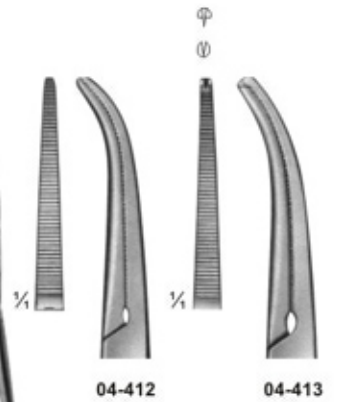

Delicate Haemostatic Forceps

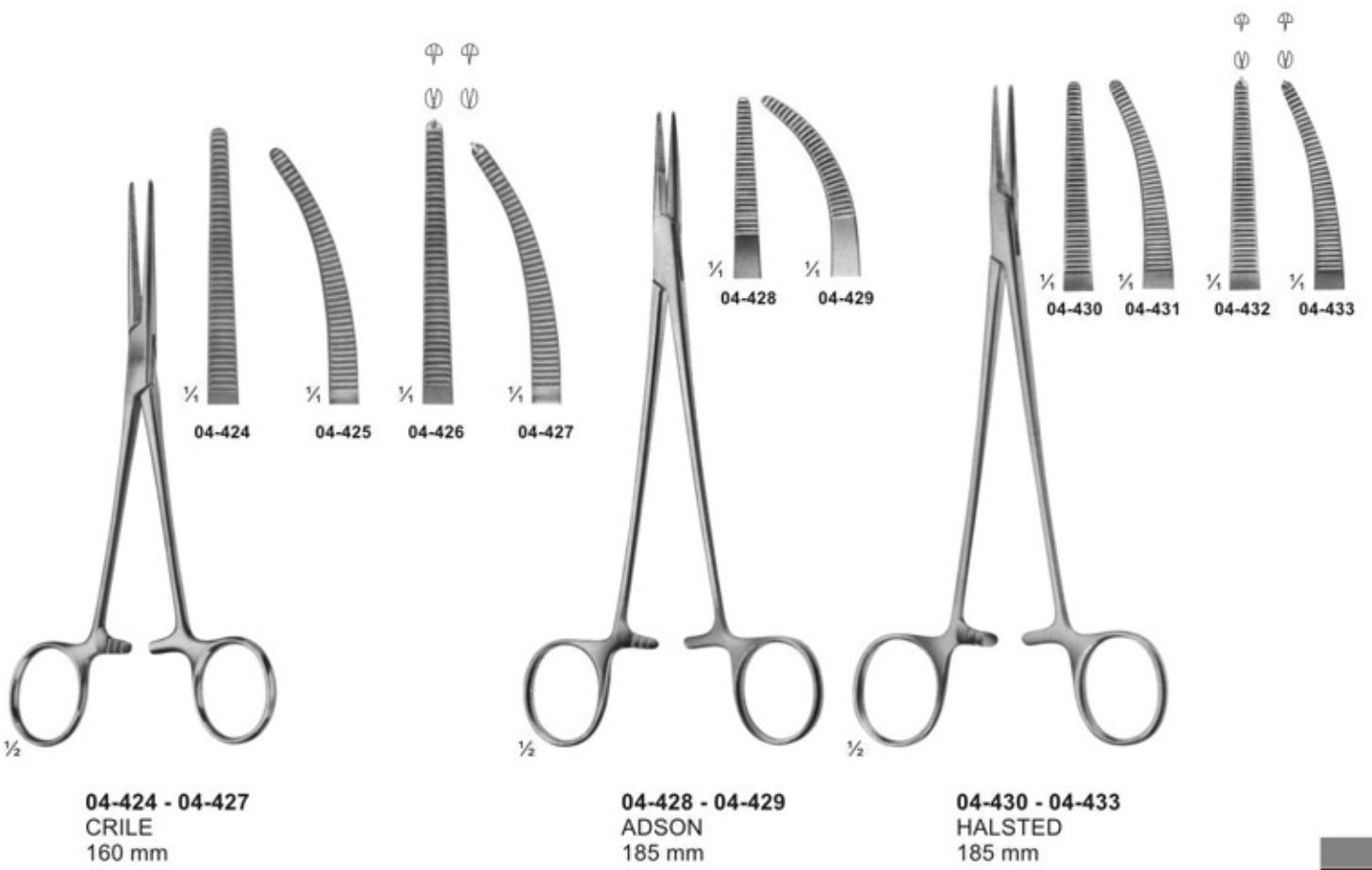
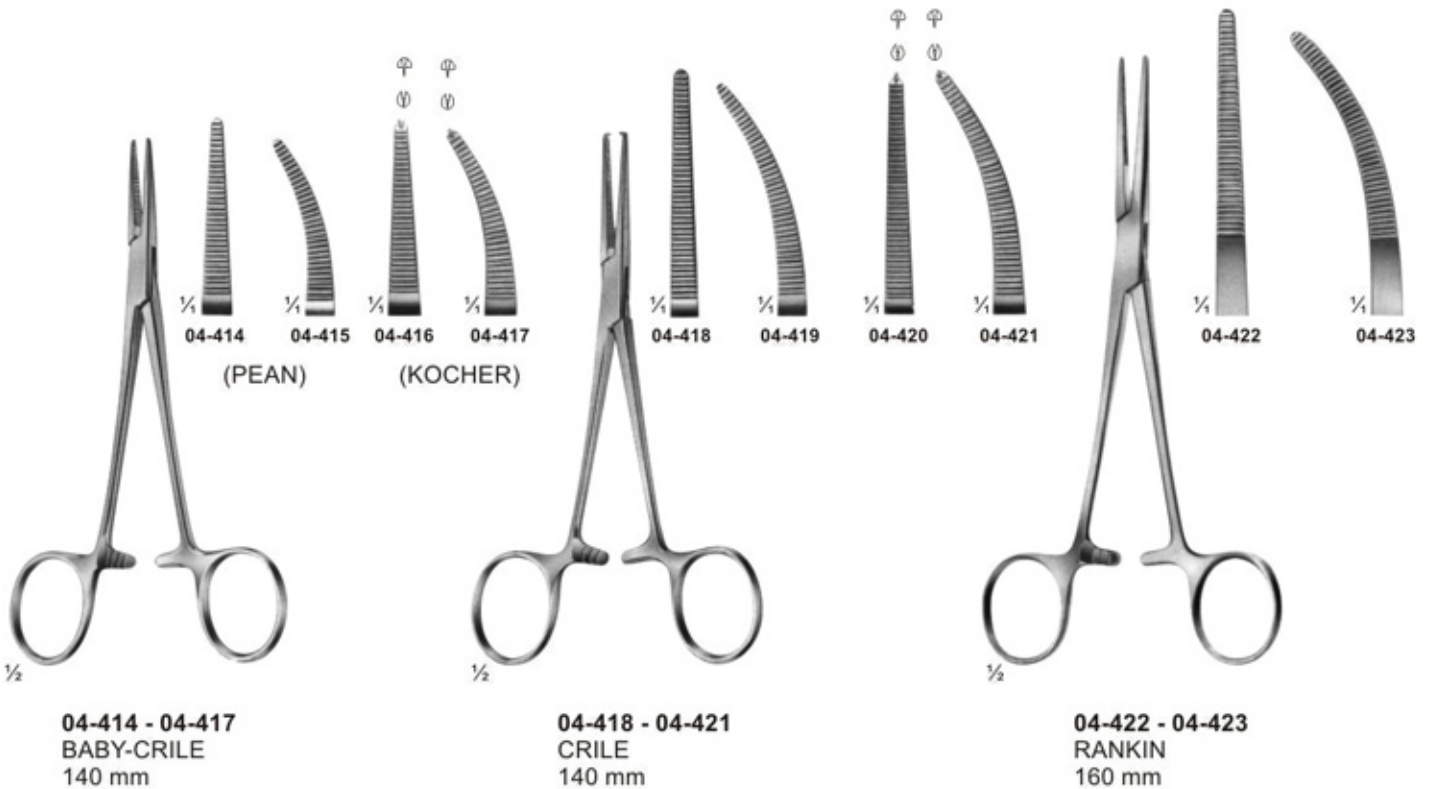

Haemostatic Forceps

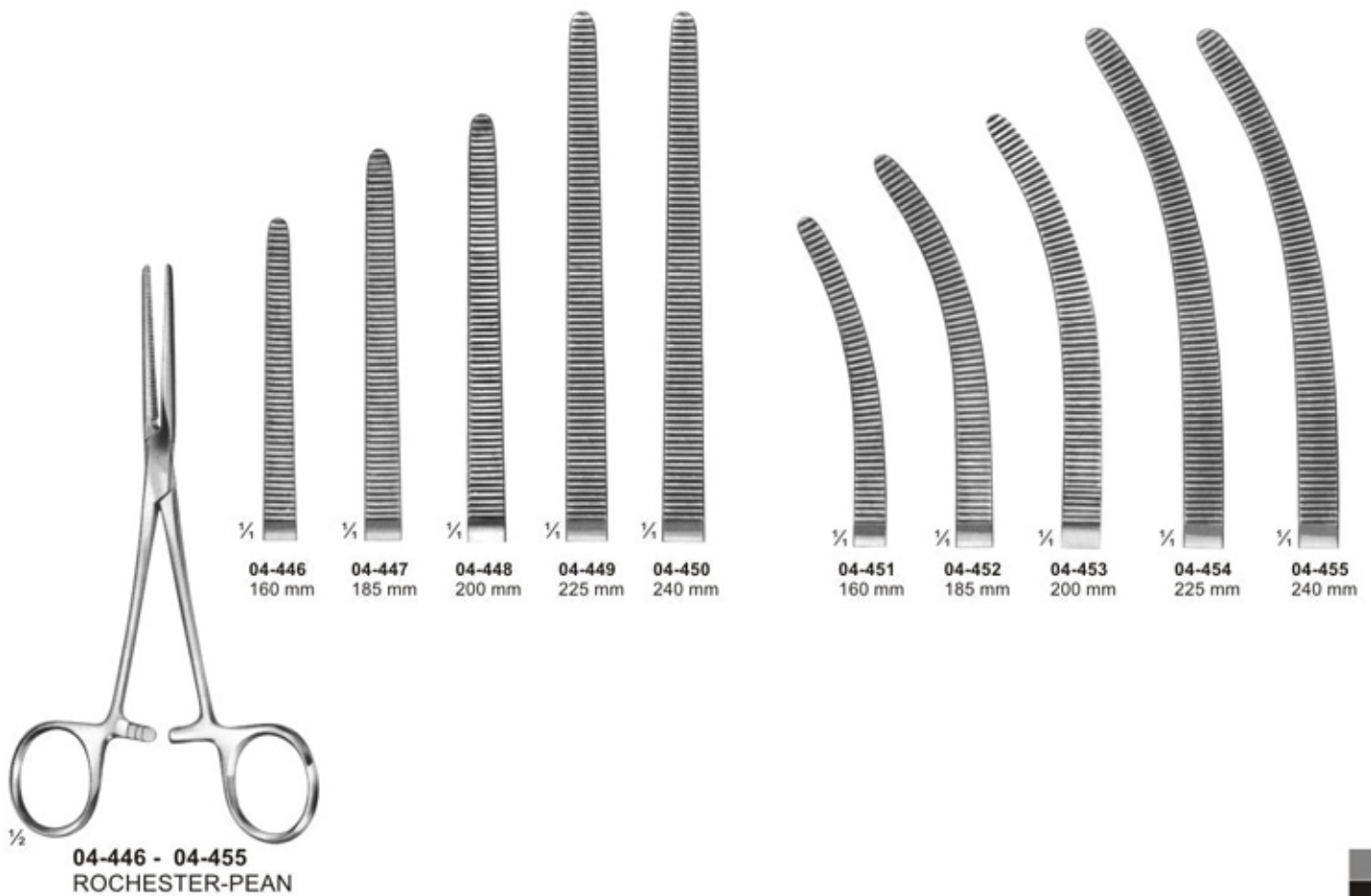
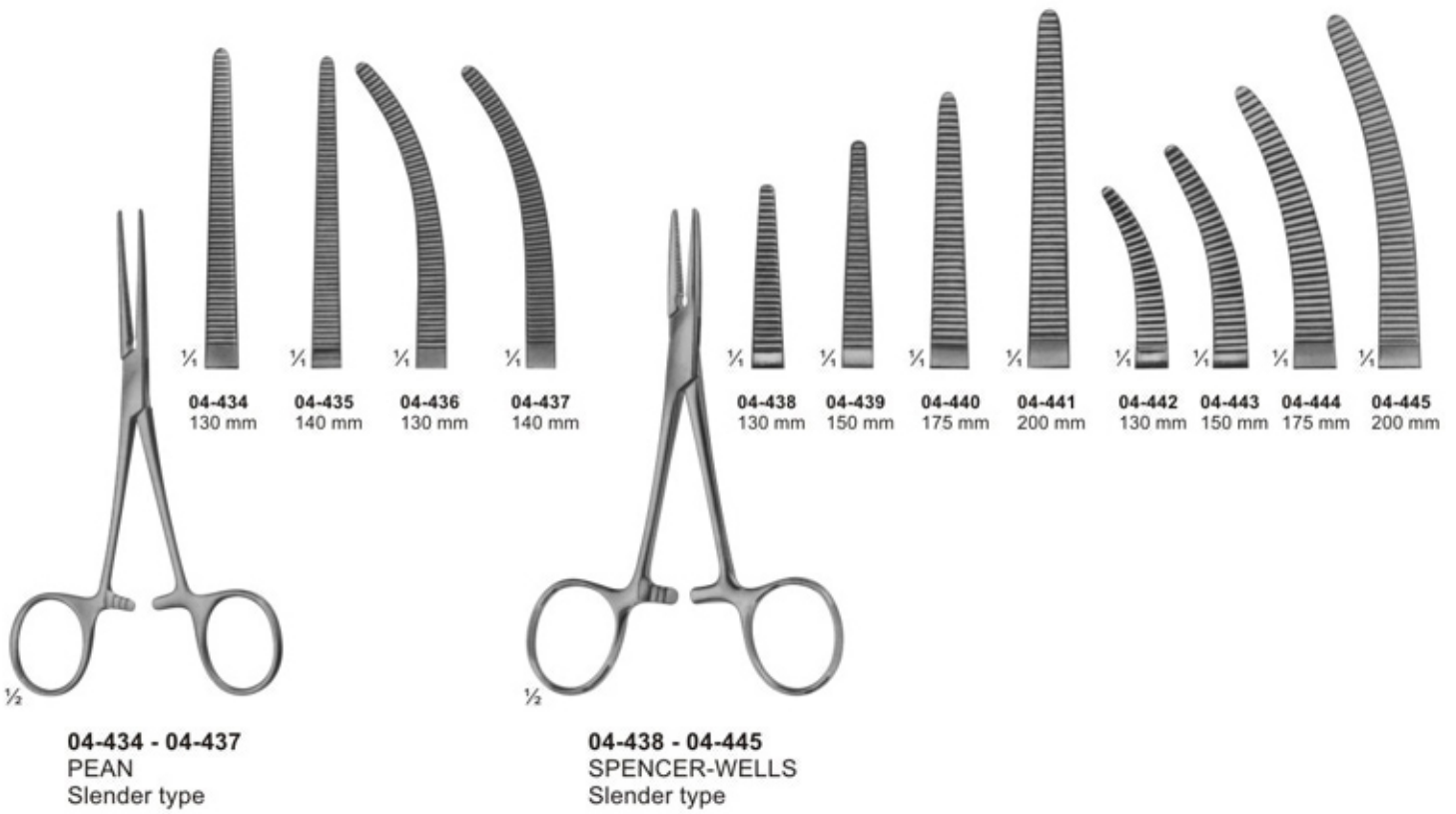

Haemostatic Forceps



04-456 - 04-461
PEAN

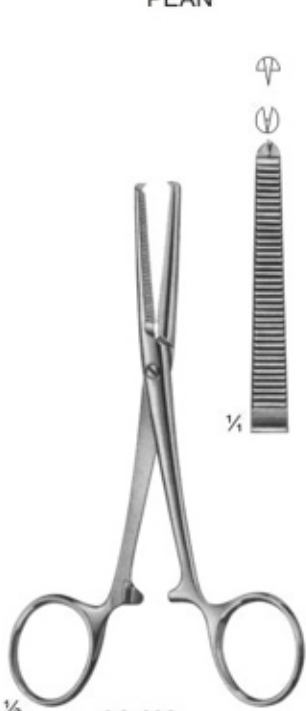
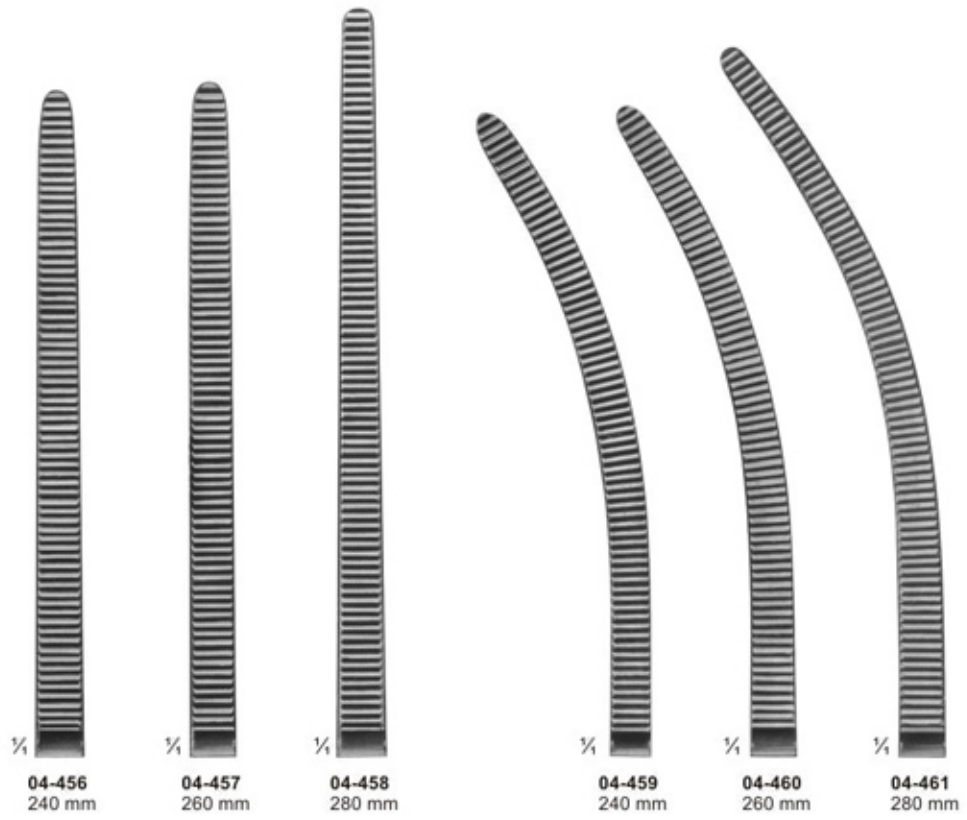

04-462
KOCHER
Strong Pattern
145 mm

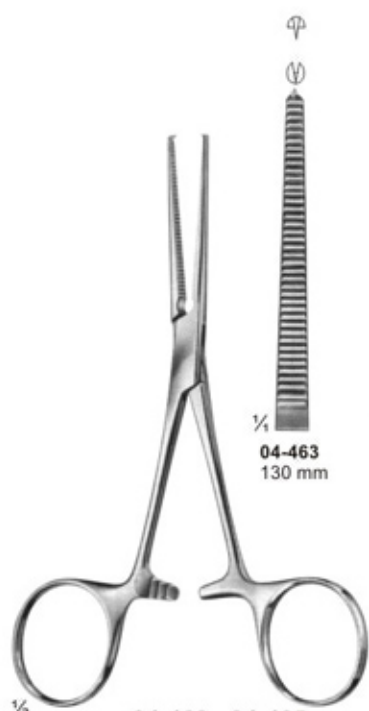

04-463 - 04-465
KOCHER

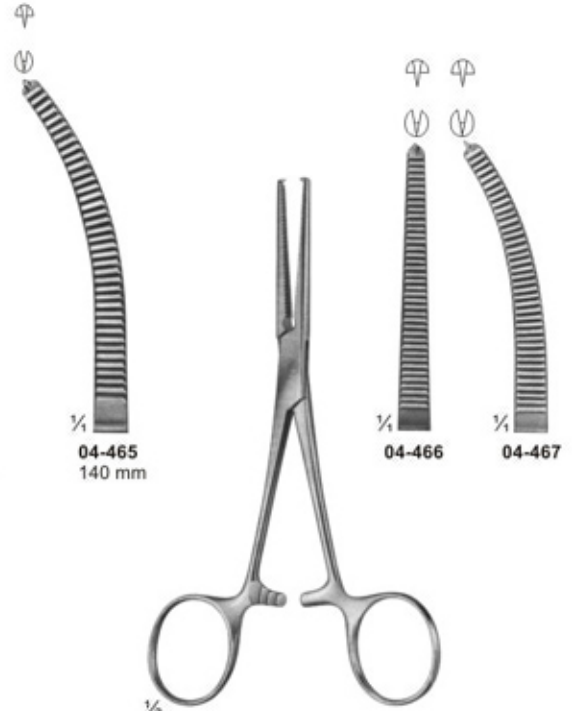

04-466 - 04-467
ROCHESTER-OGHSNER
140 mm

Haemostatic Forceps

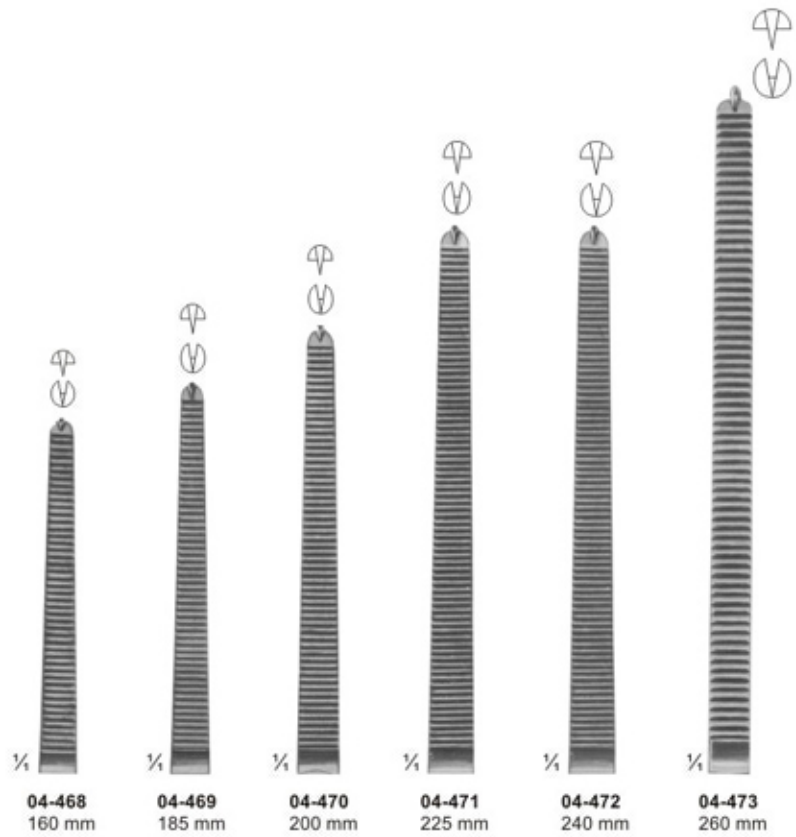

04-468 - 04-479
KOCHER-OCHSNER

Haemostatic Forceps

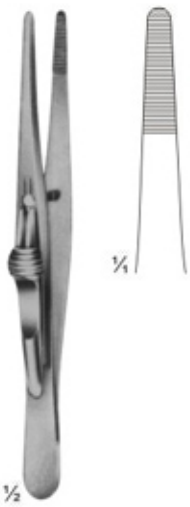

04-480
FRICKE
Artery forceps
130 mm



04-481
KRONLEIN
130 mm

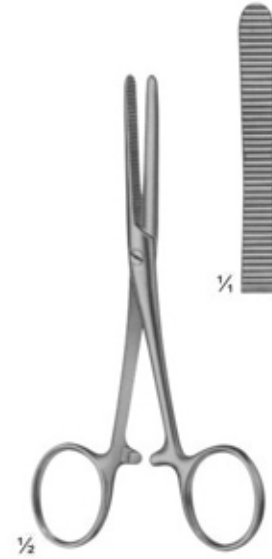

04-482
PEAN
125 mm



04-483
125 mm



04-484
140 mm

04-483 - 04-484
PEAN

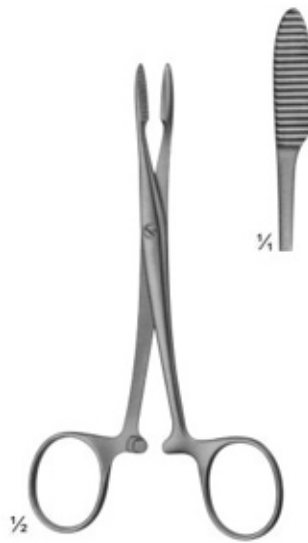

04-485
PEAN
125 mm

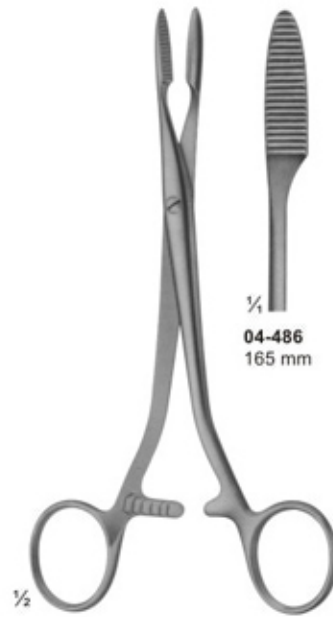

04-486
165 mm



04-487
185 mm

04-486 - 04-487
PEAN

Haemostatic Forceps, Special Pattern, Tonsil Forceps

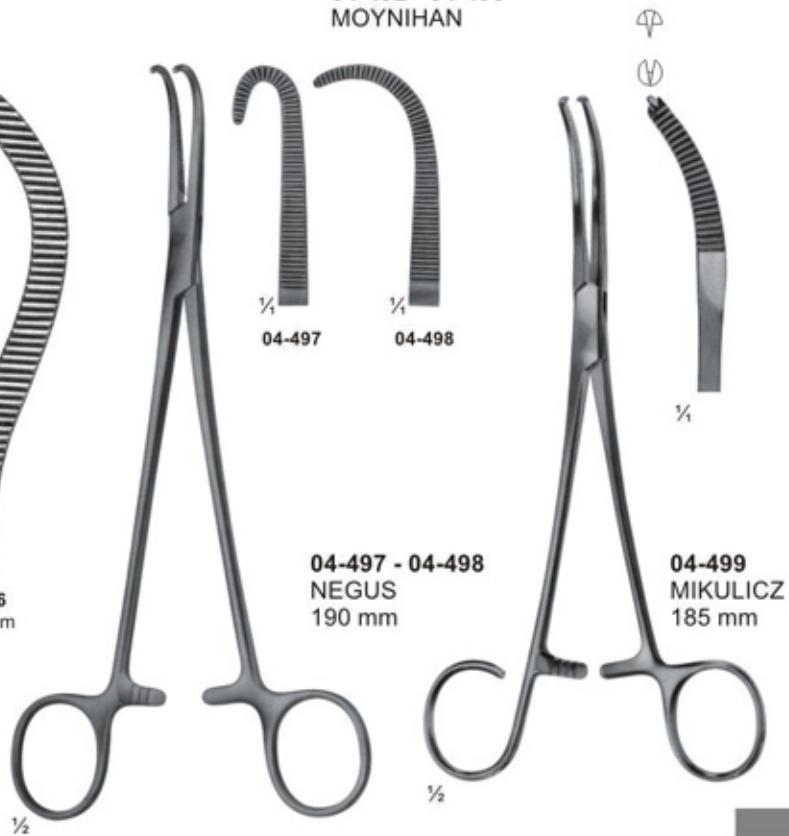

Dissecting- and Ligature Forceps



1/2
04-500
 MIXTER-O'SHAUGHNESSY
 190 mm



1/2
04-501
 HEISS
 195 mm

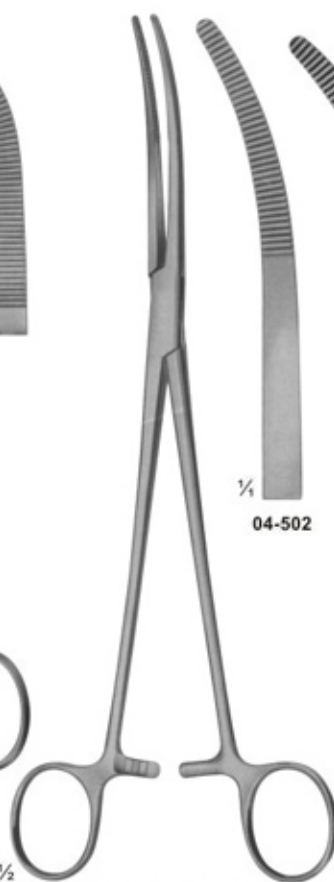

1/2
04-502 - 04-506
 RUMEL
 240 mm

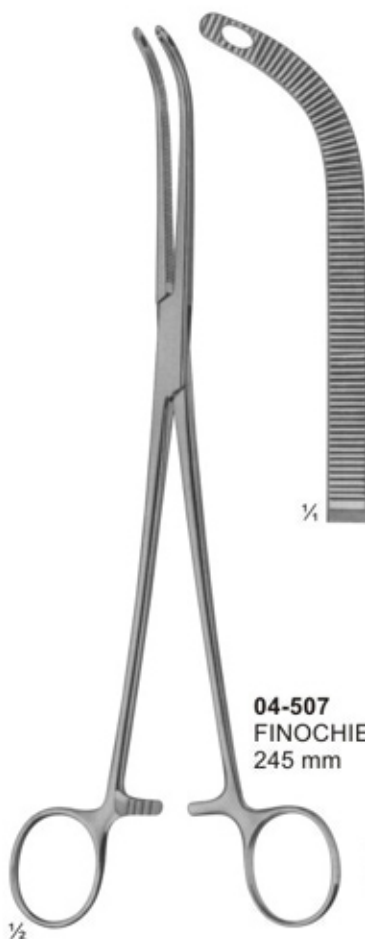
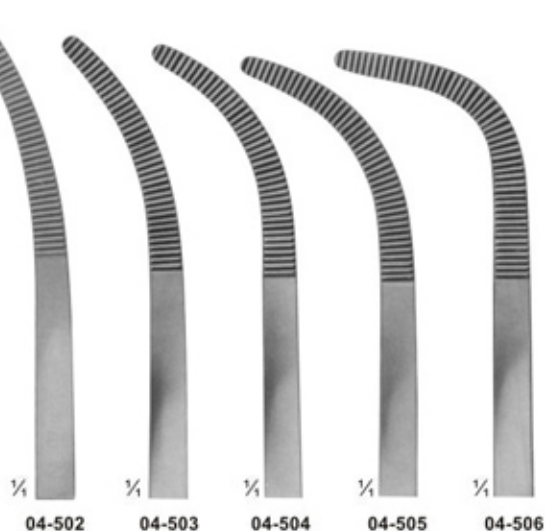

1/2
04-507
 FINOCHIETTO
 245 mm

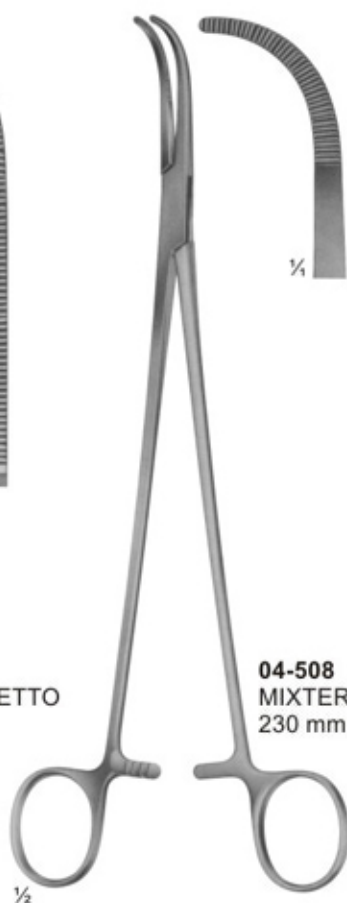

1/2
04-508
 MIXTER
 230 mm



1/2
04-509
 LAWRENCE
 270 mm

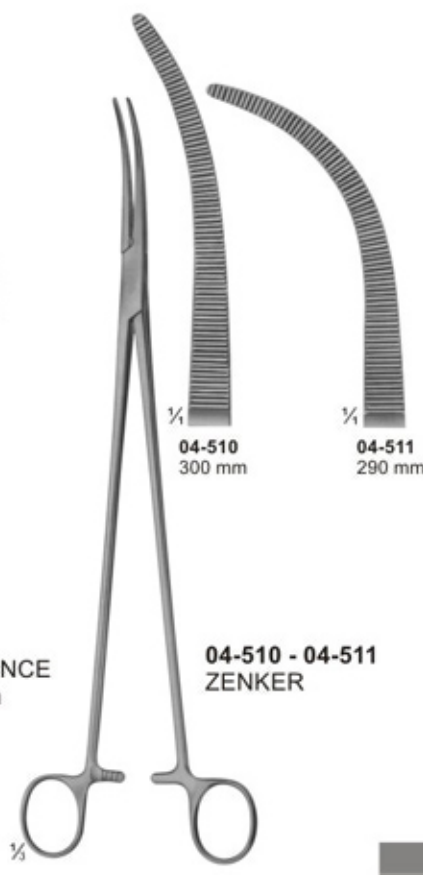

1/2
04-510 - 04-511
 ZENKER

Hysterectomy Forceps, Vaginal Clamps
and Compression Forceps



04-512
WERTHEIM
Hysterectomy forceps
255 mm

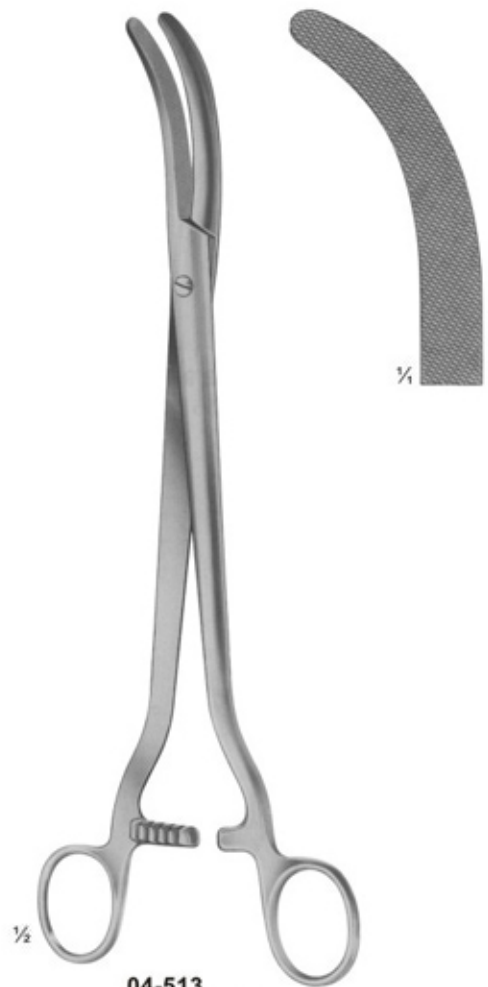

04-513
WERTHEIM
Parametrium clamp
260 mm

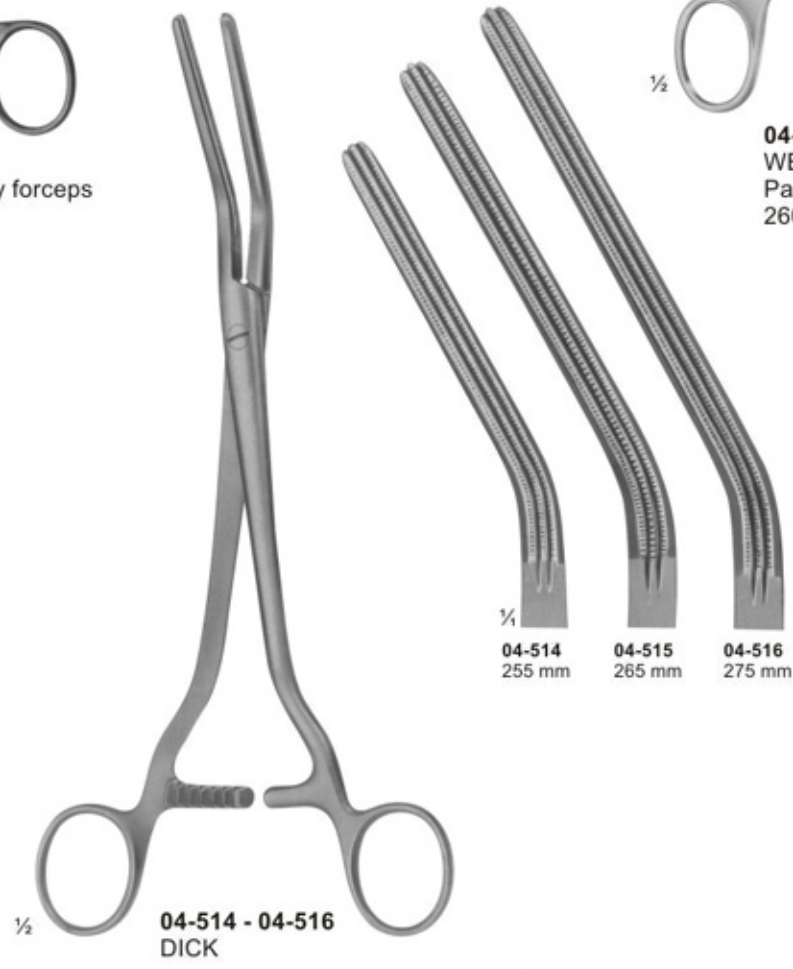

04-514 - 04-516
DICK

04-514 255 mm
04-515 265 mm
04-516 275 mm

Hysterectomy Forceps, Vaginal Clamps
and Compression Forceps



04-517
WERTHEIM
250 mm



1/4

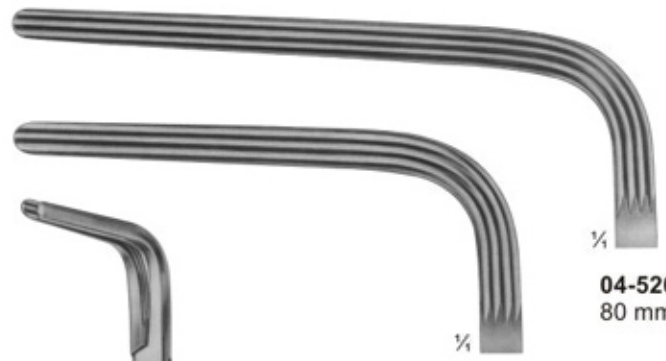

04-520
80 mm

04-519
60 mm



04-518
WERTHEIM-CULLEN
215 mm

1/2



1/4



04-519 - 04-520
230 mm

1/2

Needle Holders for micro surgery



05-101
ROHRSCHEIDER
with copper inserts
100 mm



05-102
KALT
with catch
135 mm



05-103
ARRUGA
with catch
135 mm



05-104 - 105
CASTROVIEJO
with catch
145 mm



05-106 - 107
without Catch
160 mm



05-108 - 109
without catch
185 mm

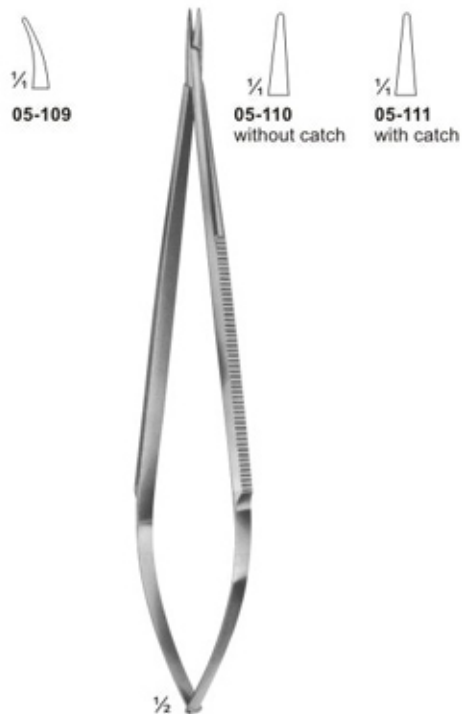

05-110 - 111
JACOBSON
185 mm



05-112
without catch
195 mm



05-113 - 114
YASARGIL
with catch
200 mm

Needle Holders

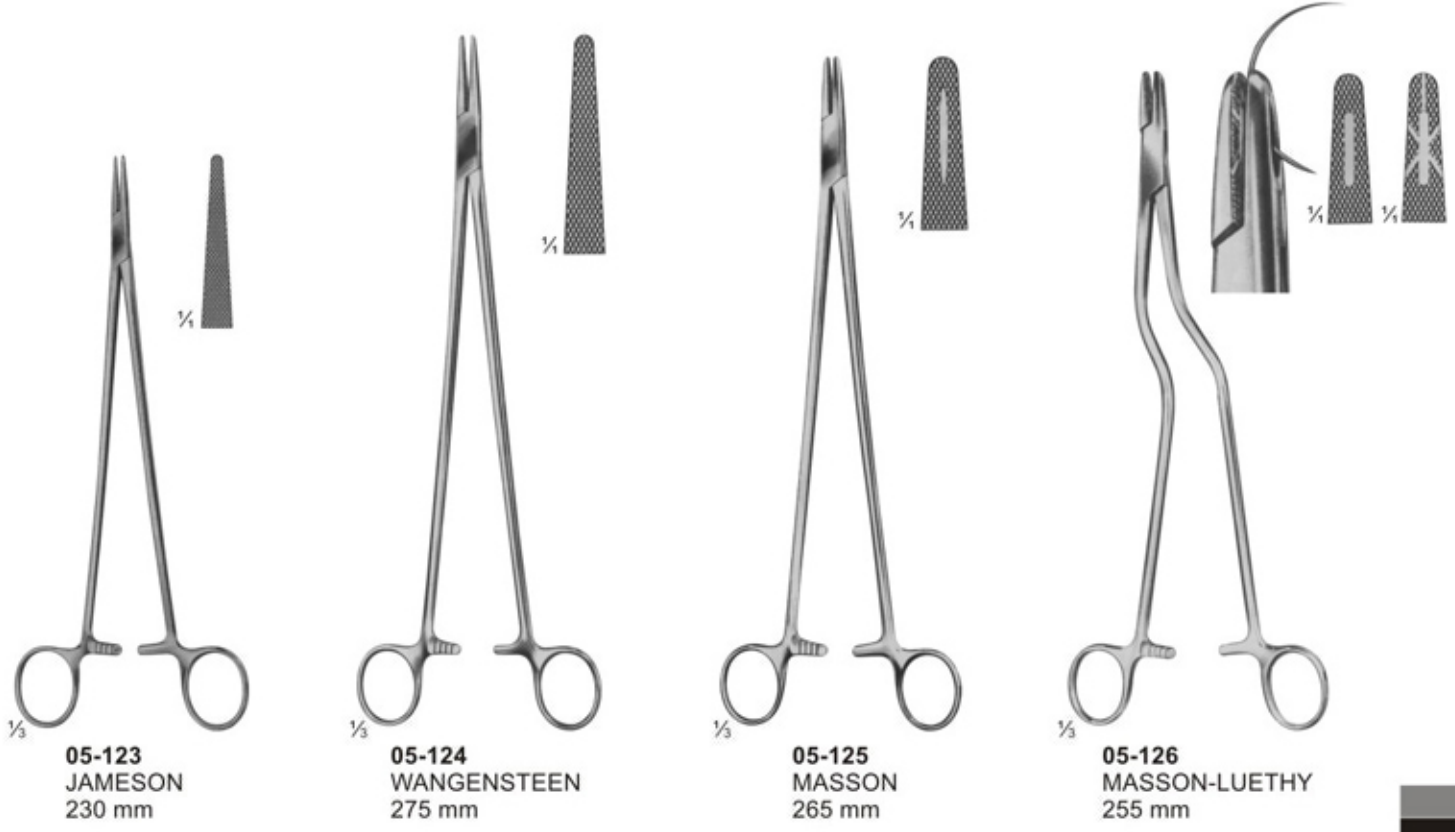

Needle Holders

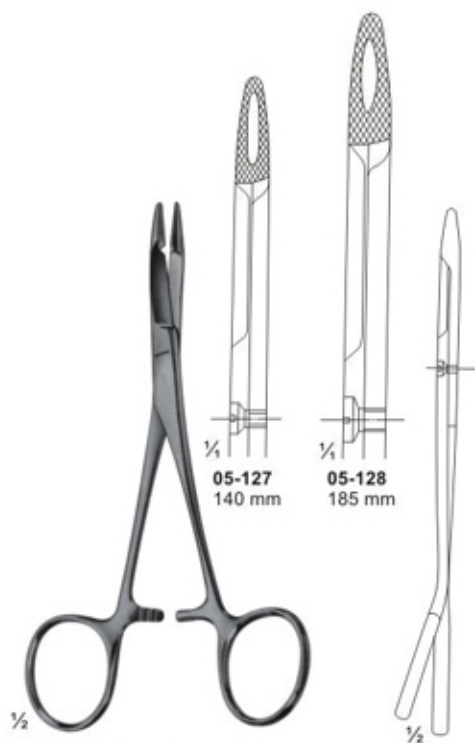

05-127 - 128
HEGAR-OLSEN
255 mm

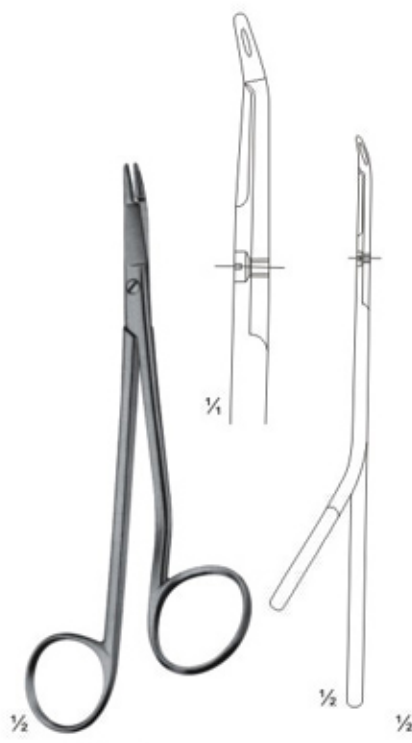

05-129
GILLIES
150 mm



05-130
GILLIES
160 mm



05-131
EISELSBERG
115 mm

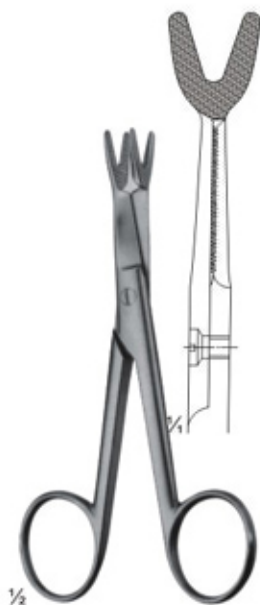

05-132
SCHOEMAKER-LOTH
125 mm



05-133
CRILE
150 mm



05-134
TOENNIS
Elastic pattern for dura-or
intestinal suture. 180 mm

Needle Holders

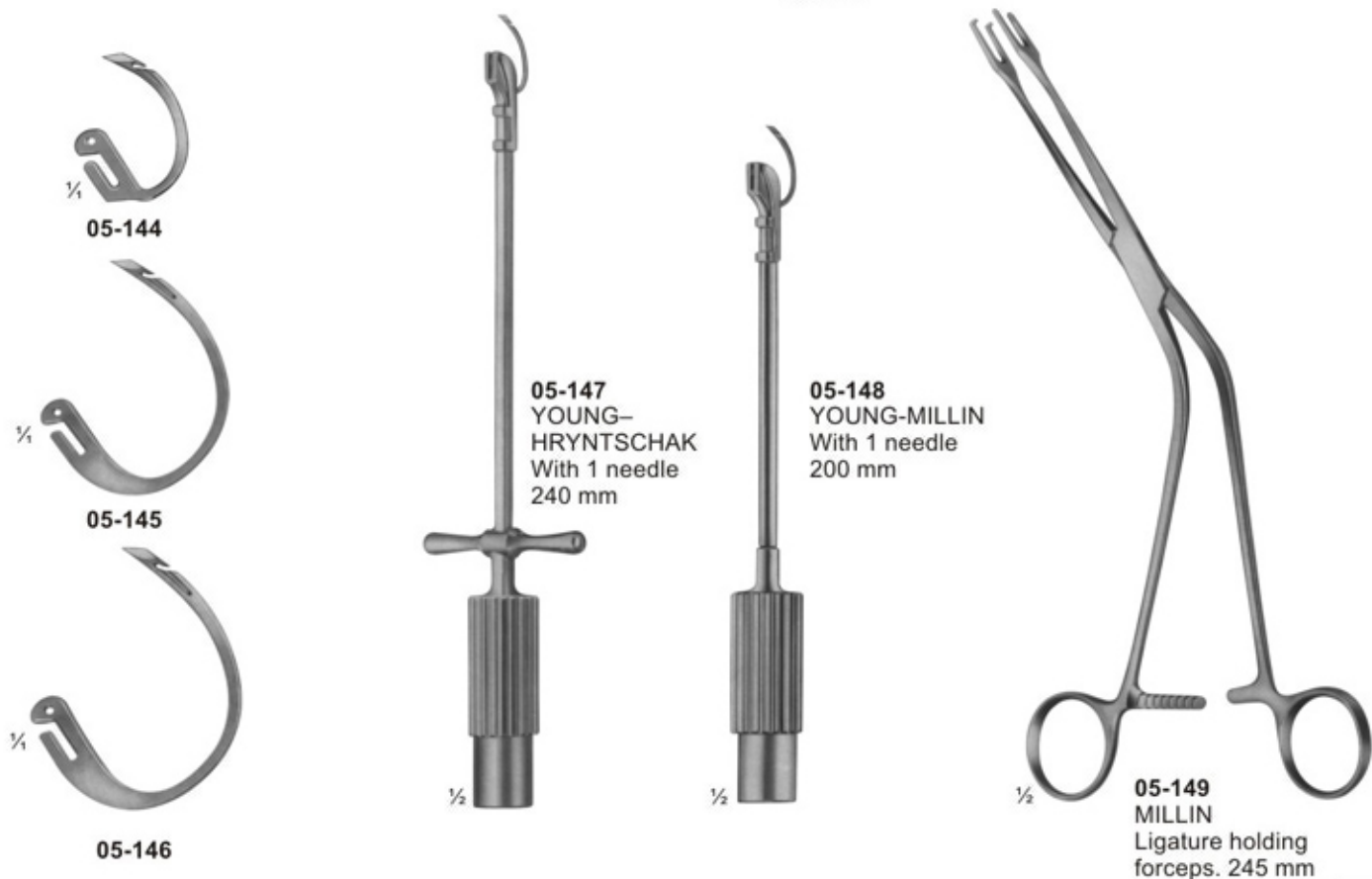
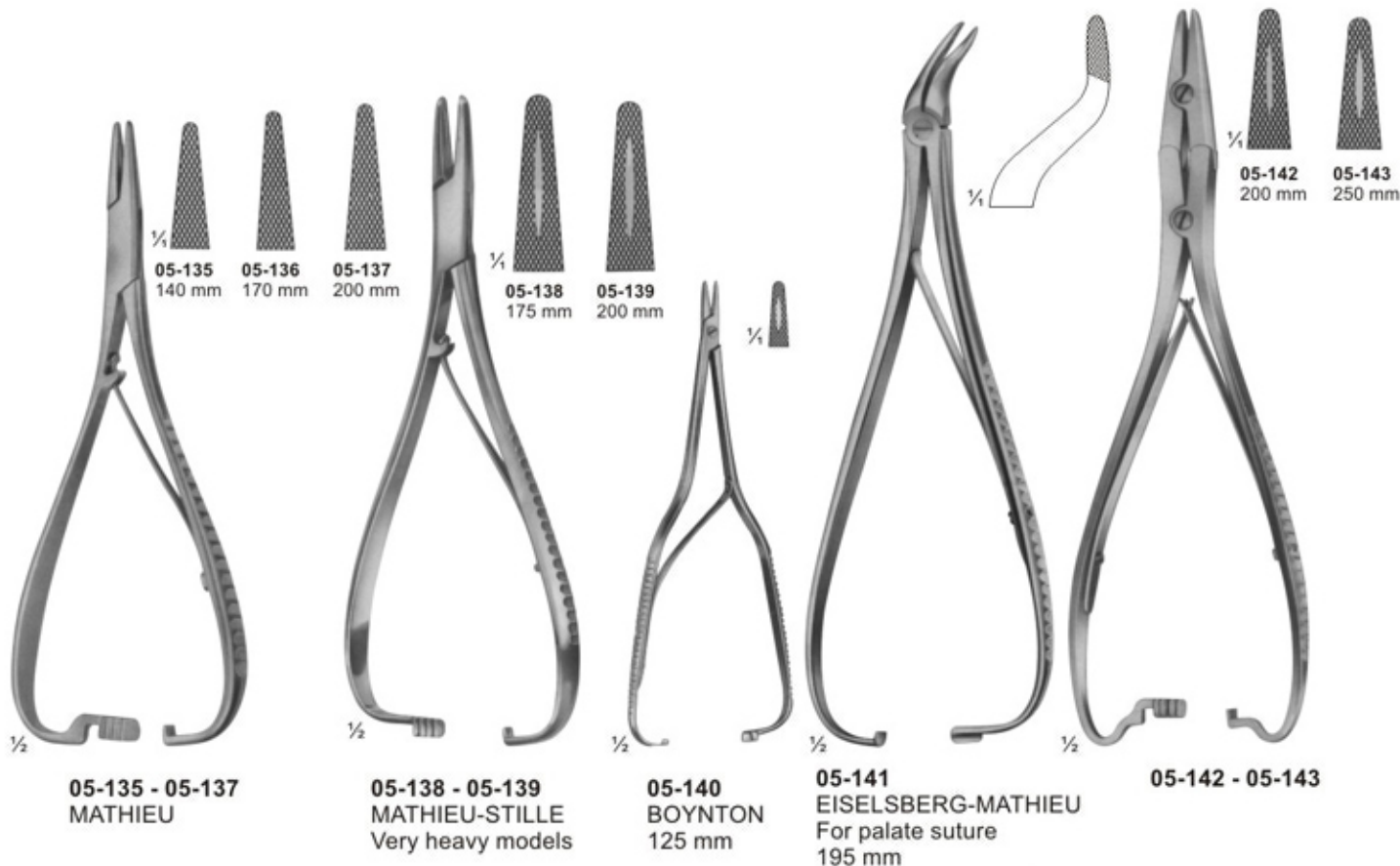

Suture Instruments - Reverdin Needles

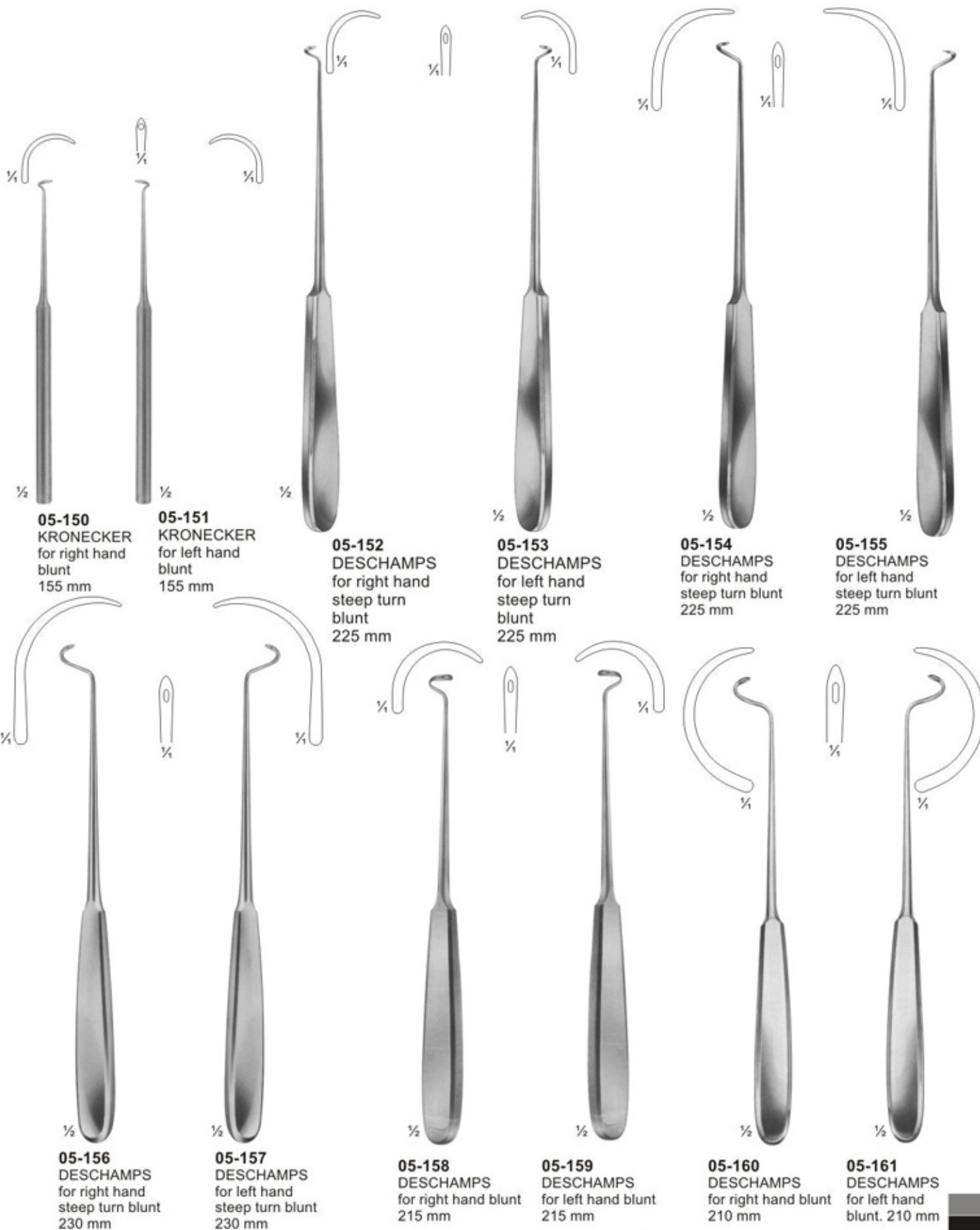

Probes



05-162 130 mm
05-163 145 mm
05-164 160 mm
Directors



05-165
DOYEN
145 mm
Directors



05-166
NELATON
160 mm
Directors



05-167
Director with tip
Diam. Of tip 3,3 mm
140 mm

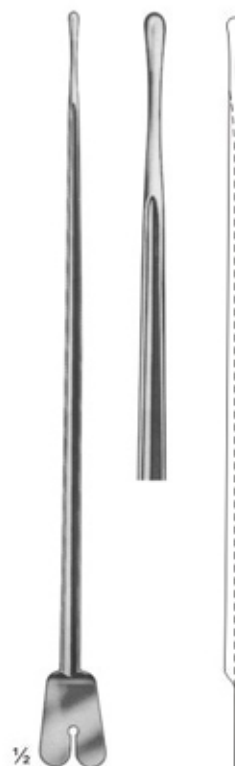

05-168
BRODIE
Director with tip,
Diam. Of tip 3,5 mm
200 mm

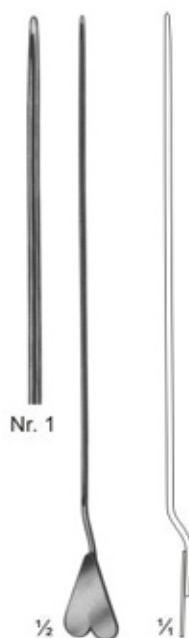

05-169
LOCKHART-MUMMERY
165 mm

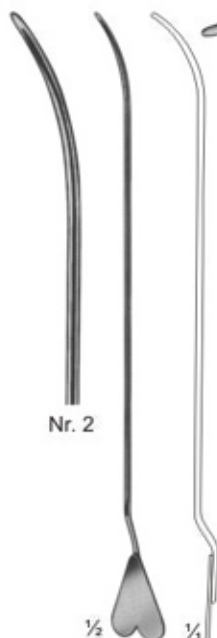

05-170
LOCKHART-MUMMERY
165 mm

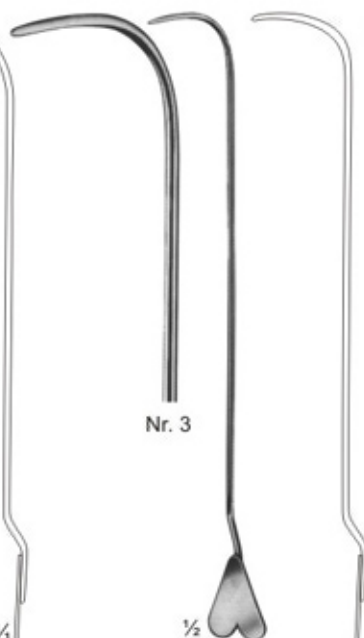

05-171
LOCKHART-MUMMERY
165 mm

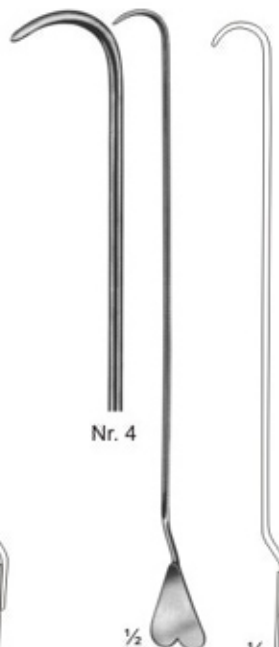

05-172
LOCKHART-MUMMERY
165 mm



05-173
Director with wire
loop, malleable
190 mm

Probes



05-174 145 mm
05-175 160 mm
05-176 200 mm
Probes with eye



05-177
Myrtle leaf probe
145 mm



05-178 130 mm
05-179 145 mm
05-180 160 mm
05-181 180 mm
05-182 200 mm



05-183
Probes



05-184
Double ended probe,
malleable, diam. of tips
3 mm with hole
190 mm



05-185
Double ended probes,
tin, malleable,
diam. of tips
3,5 mm with hole
250 mm, 300 mm



05-186
Double ended probes,
tin, malleable,
diam. of tips 4 mm
400 mm



05-187 1,5 mm
05-188 2,0 mm
05-189 2,5 mm
300 mm

Suturing Instrument Set, Pocket Instrument Set



05-190

Suturing instruments set, in metal case consisting of: Scissors, curved, sharp/sharp, 115mm
25 MICHEL clip, 16 x 3mm
1 Delicate tissue forceps, 130mm
1 Scalpel, bellied
1 MATHIEU needle holder, 140mm
1 Perforated metal case, stainless containing:
1 Suture needle
1 item 1 item



05-191

Pocket instrument set, in metal case consisting of:

Bottom tray

1 MATHIEU needle holder, 140mm
1 MICHEL clip forceps, combined
1 Myrtle leaf probe, 130mm
1 Sharp double curette
1 Skin hook
1 Detachable scalpel handle, no.4
1 Perforated metal case, containing
6 Scalpel blades
1 Perforated metal case, stainless, containing
1 Suture needle
1 item
1 item



Top tray

1 Tissue forceps, 130mm
1 KOCHER haemostatic forceps, 130mm
1 Straight surgical scissors, 130mm
1 Dissecting forceps, 130mm
1 FEILCHENFELD splinter forceps, 115mm
25 MICHEL clip, 16 x 3mm
1 Flacon of suture skin, sterile in alcohol



05-192

Pocket instrument set, in metal case consisting of:

Bottom tray

1 MAYO-HÉGER needle holder, 150mm
1 MICHEL clip forceps, combined
1 Myrtle leaf probe, 130mm
1 Sharp double curette
1 Skin hook
1 Detachable scalpel handle, no. 4
1 Perforated metal case, consisting
6 Scalpel blades
1 Perforated metal case, stainless, consisting:
1 Suture needle
1 item, & 1 item



Top tray

1 Tissue forceps, 130mm
1 CRILE haemostatic forceps, 140mm
1 Straight surgical scissors, 130mm
1 Dissecting forceps, 130mm
1 FEILCHENFELD splinter forceps, 115mm
25 MICHEL clip, 16 x 3mm
1 Flacon of suture silk, sterile in alcohol

Fine Wound Retractors (Dura- and Skin Retractors)

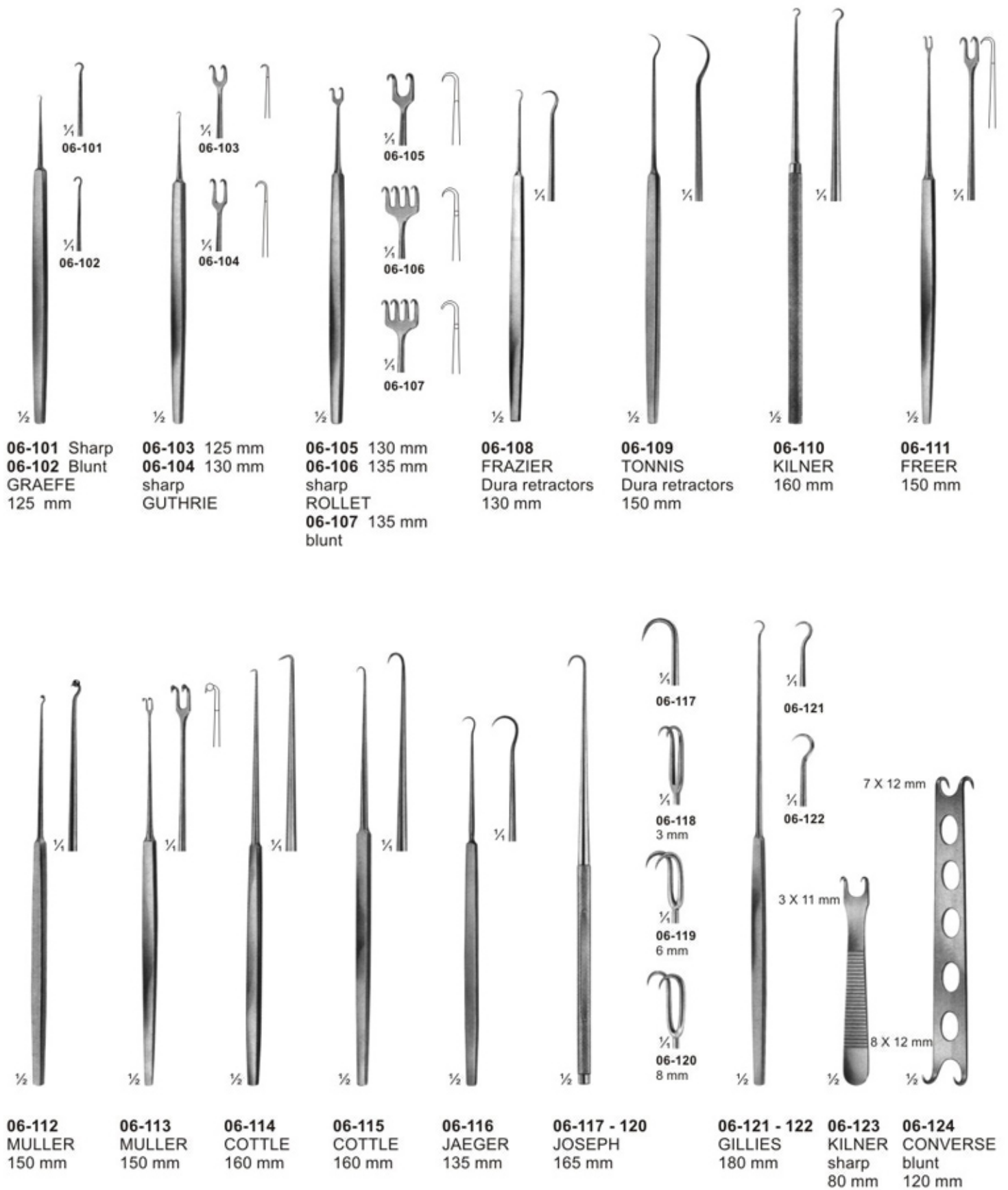

Retractors With treangle handle

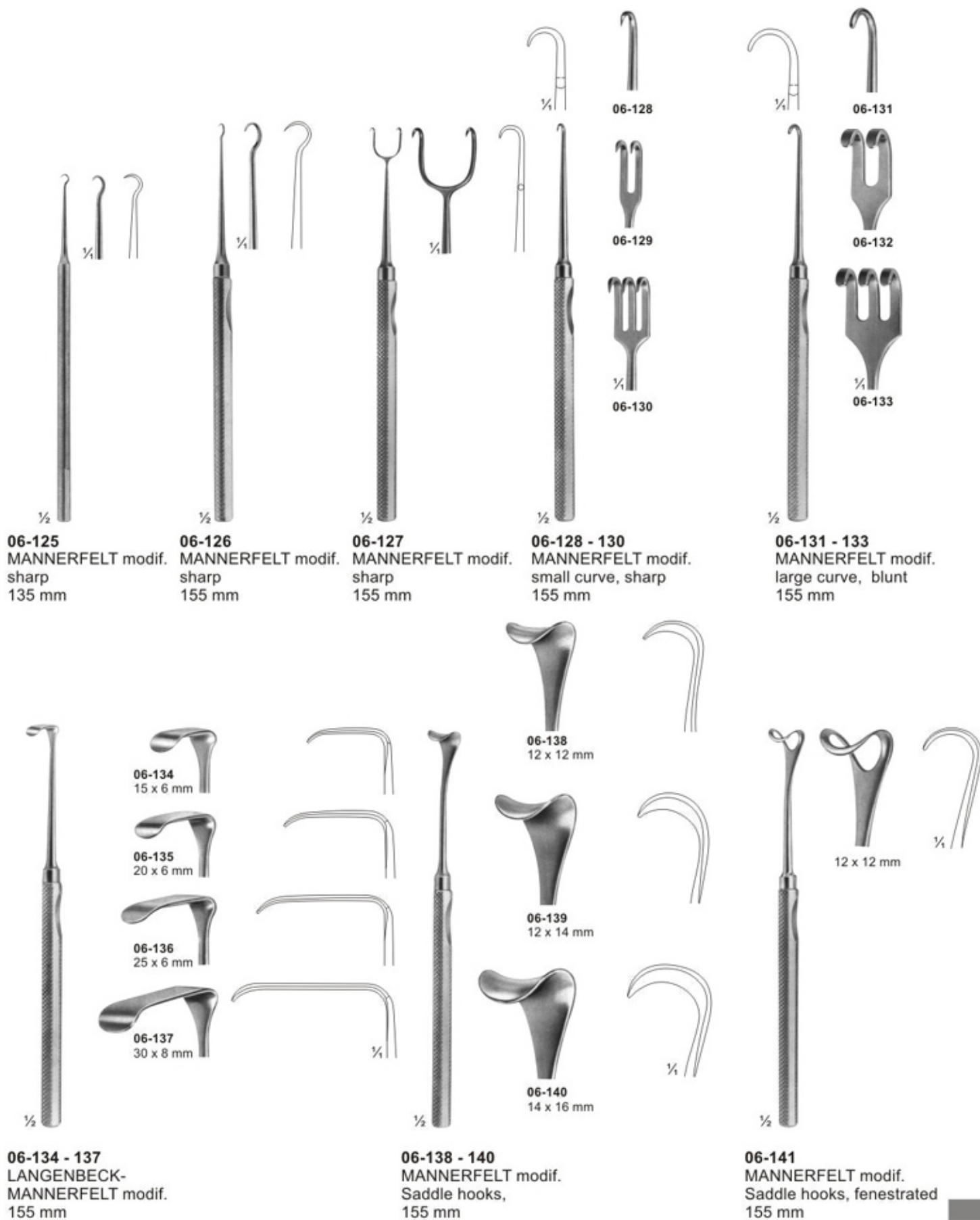

Retractors



06-142
MASING
140 mm



06-143
COTTLE
140 mm



06-144 - 148
DESMARRES
140 mm



06-145
9 x 12 mm



06-146
11 x 14 mm



06-147
12 x 16 mm



06-148
13 x 18 mm



06-149
13 x 13 mm



06-150
12 x 16 mm

06-149 - 150
KONIG
180 mm



06-151
10 x 10 mm

06-151
CUSHING-KOCHER
175 mm



06-152
20 x 12 mm



06-153
20 x 15 mm

06-152 - 153
KOCHER
205 mm



06-154
13 x 6 mm

06-154
SCHOENBORN
200 mm



06-155
10 x 13 mm

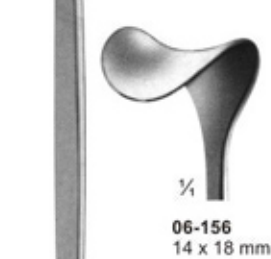

06-156
14 x 18 mm

06-155 - 156
CUSHING
205 mm



20 x 15 mm

20 x 19 mm

06-157
205 mm

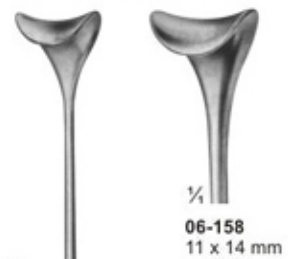

06-158
11 x 14 mm

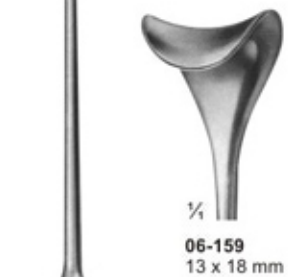

06-159
13 x 18 mm

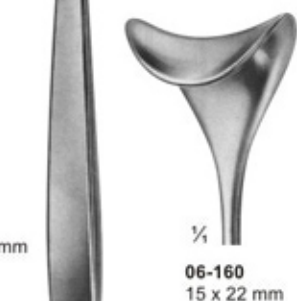

06-160
15 x 22 mm

06-158 - 160
CUSHING
250 mm

Retractors

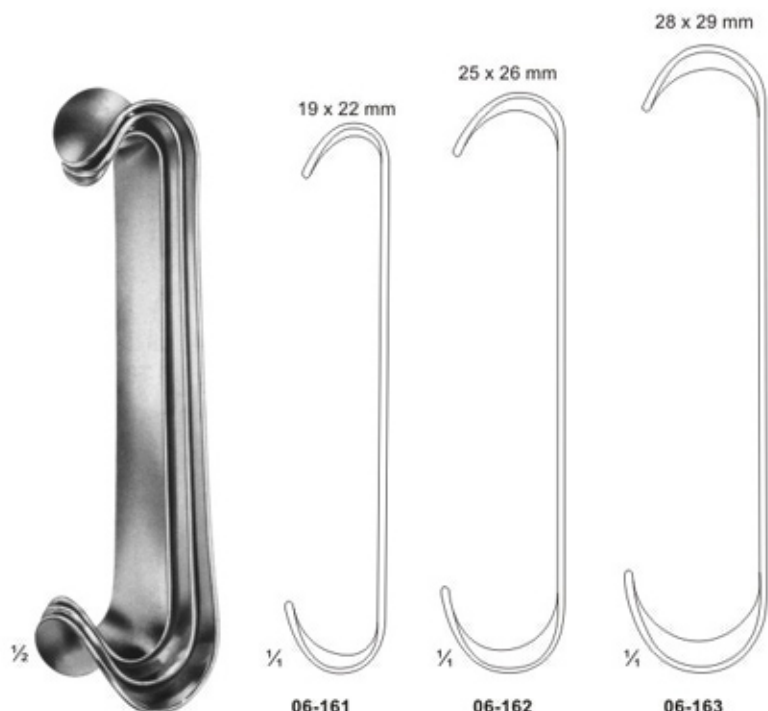

06-161 - 163
ROUX
Set
165 mm

06-161
23 x 30 mm

06-162
28 x 38 mm

06-163
33 x 45 mm



06-164 - 165
ROUX

06-164
25 x 29 mm
150 mm

06-165
30 x 38 mm
160 mm

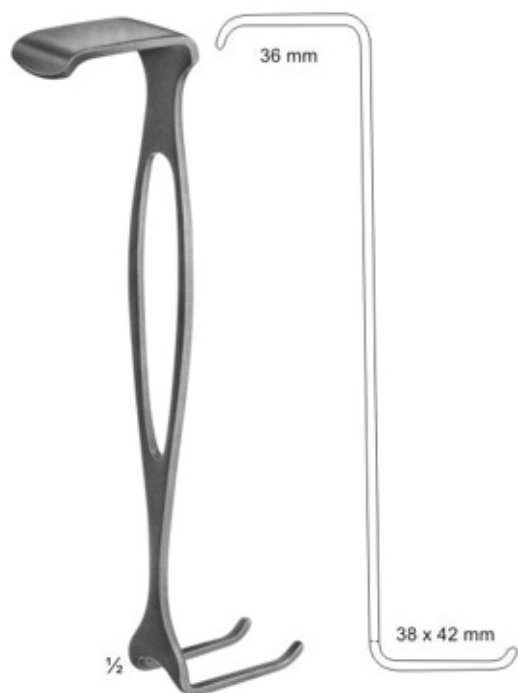

06-166
CZERNY
175 mm

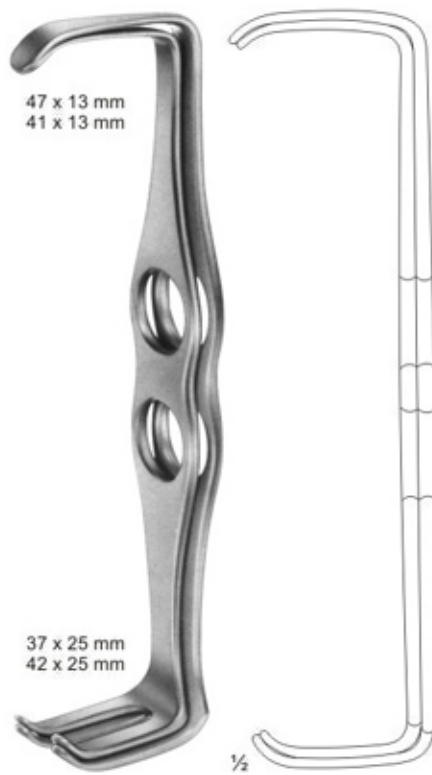

06-167
MATHIEU
200 mm



06-168
US-ARMY
220 mm

Retractors



06-169 - 06-170
BABY-SENN-MILLER
155 mm

06-171
SENN-MILLER
165 mm

06-172
COLLIN-HARTMANN
150 mm

STERBERG
06-173 120 mm
06-174 130 mm
06-175 135 mm
06-176 140 mm

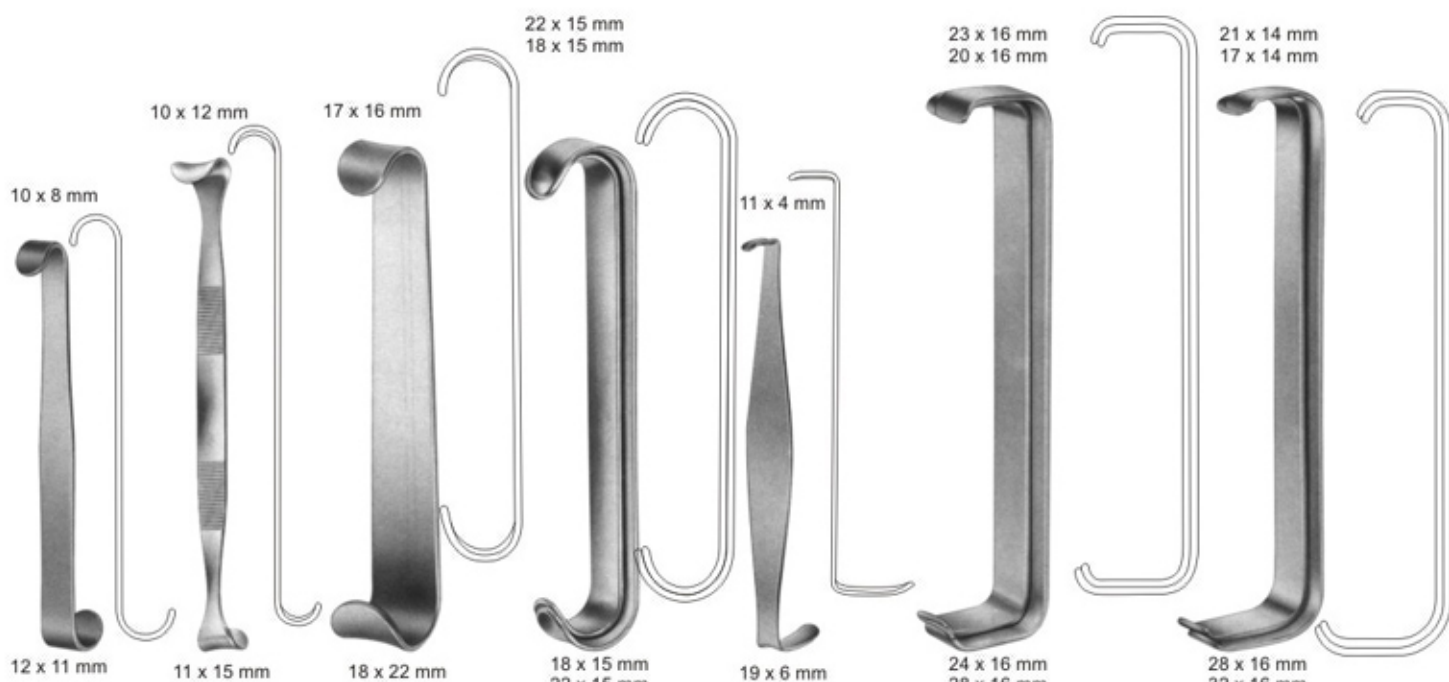

06-177
LUER
110 mm

06-178
ROSE
130 mm

06-179
BABY-ROUX
135 mm

06-180
PARKER
135 mm

06-181
CRILE
110 mm

06-182
FARABEUF
150 mm

06-183
COLLIN
150 mm

Bone Retractors and Retractors



06-184
KOCHER
sharp
205 mm



06-185
KOCHER
sharp
220 mm



06-186
KOCHER
sharp
220 mm



06-187
VOLKMANN
blunt
220 mm



06-188
VOLKMANN
sharp
220 mm



06-189 - 06-196
VOLKMANN
225 mm

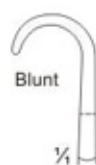
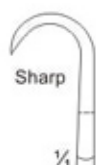

06-189
9 x 8 mm



06-190
9 x 13 mm



06-191
9 x 19 mm



06-192
9 x 29 mm



06-193
8,5 x 8 mm



06-194
8,5 x 13 mm



06-195
8,5 x 19 mm



06-196
8,5 x 29 mm

Retractors



1/2
06-197
15 x 15 mm
220 mm



1/2
06-198
20 x 22 mm
215 mm

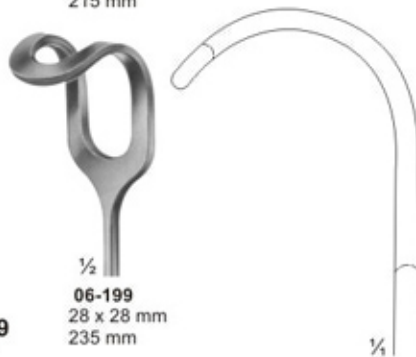

1/2
06-199
28 x 28 mm
235 mm

1/2
06-197 - 06-199
MIDDELDORPF



38 x 18 mm

1/2
06-200
BUCHS
205 mm



67 x 17 mm

1/2
06-201
CASPAR
210 mm



36 x 20 mm

1/2
06-202
KOCHER
230 mm

Retractors, Vario Retractor System



- 06-203-06-209
BRUNNER
275 mm
- 06-203 80 x 20
 - 06-204 100 x 25
 - 06-205 120 x 25
 - 06-206 130 x 30
 - 06-207 140 x 30
 - 06-208 160 x 30
 - 06-209 180 x 30



Handle arrangement verriable

Retractors, Lung Spatulas



06-211
DAVIDSON
Scapula retractor
195 mm

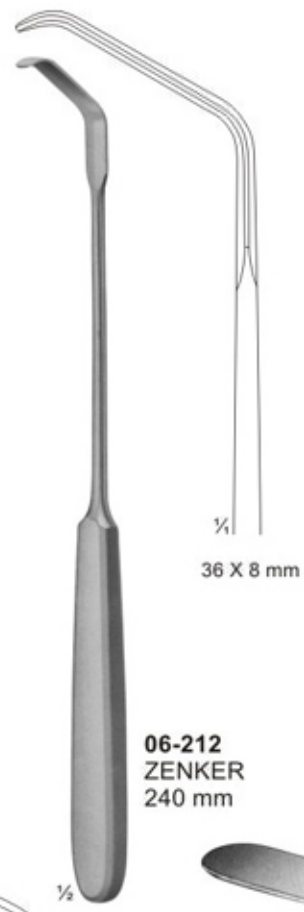

06-212
ZENKER
240 mm

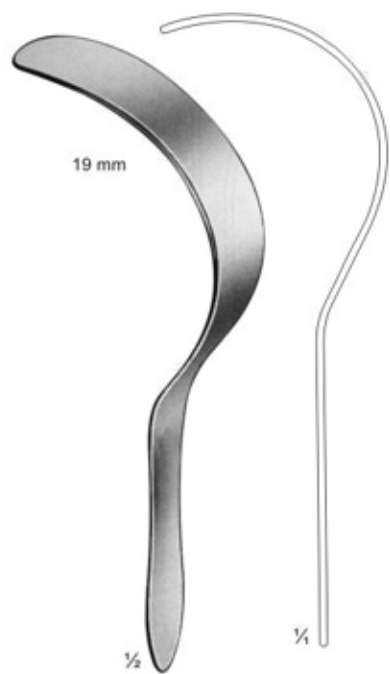

06-213
DEAVER
180 mm
Fig. 000



06-214
DEAVER
215 mm
Fig. 00



06-215
DEAVER
235 mm
Fig. 0

**Retractors for deep surgery
(Abdominal Retractors)**

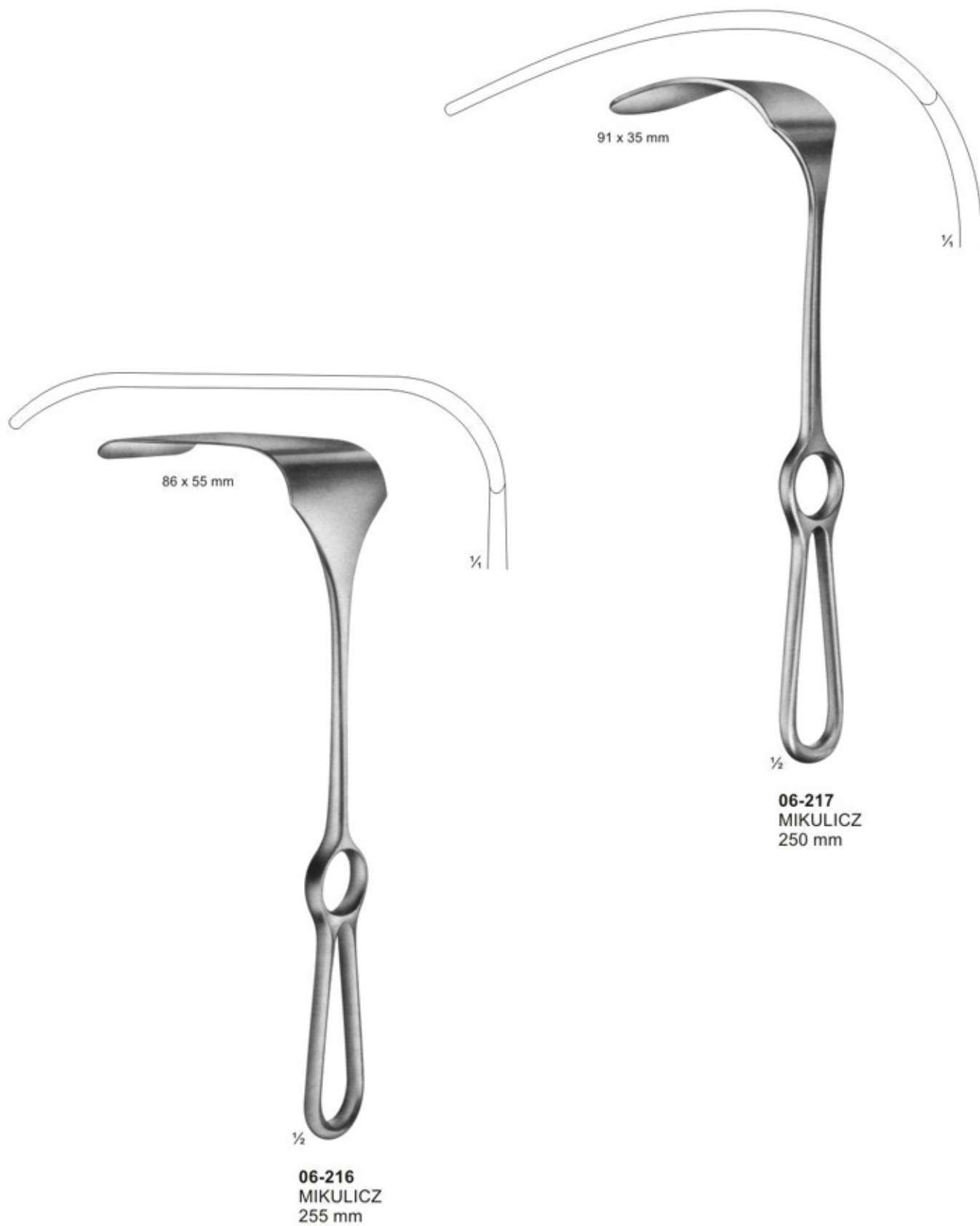

Retractors, Abdominal Retractors

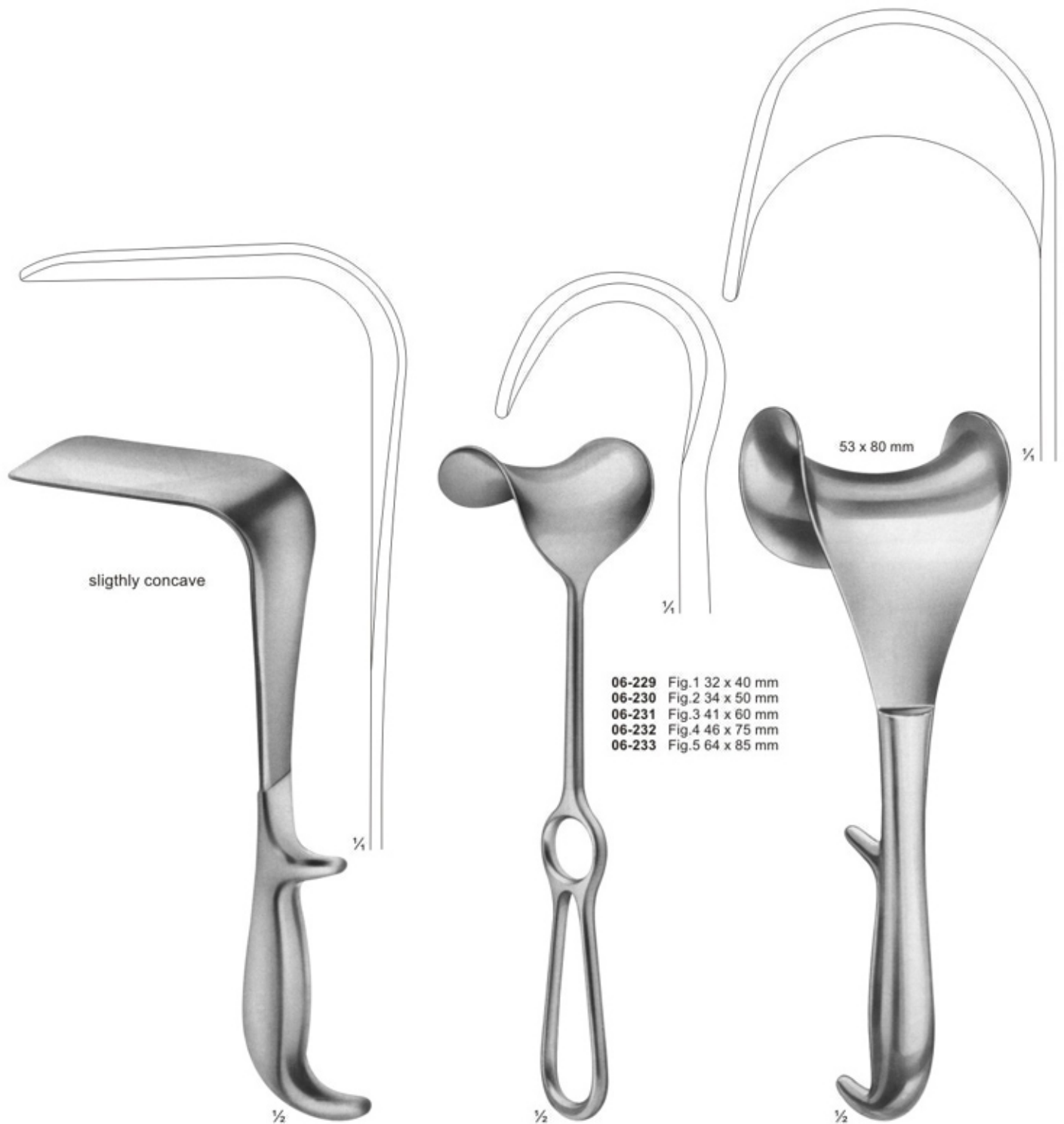

- 06-229 Fig.1 32 x 40 mm
- 06-230 Fig.2 34 x 50 mm
- 06-231 Fig.3 41 x 60 mm
- 06-232 Fig.4 46 x 75 mm
- 06-233 Fig.5 64 x 85 mm

06-218 - 06-228
DOYEN
240 mm

06-229 - 06-233
FRITSCH
240 mm

06-234
DOYEN
250 mm

	width of blades	35 mm, 45 mm, 60 mm
length of blades		
62 mm	06-218, 06-222, 06-226	
92 mm	06-219, 06-223, 06-227	
122 mm	06-220, 06-224, 06-228	
160 mm	06-221, 06-225	

Abdominal- and Intestinal Spatulas
Bauch- und Darmspatel



06-235
LERICHE
 255 mm

06-236
KUMMEL
 Mealleable
 285 mm

06-237
MIKULICZ
 29 mm
 250 mm

06-238 - 06-239
KADER
06-238 30 mm
06-239 40 mm
 270 mm

Self-Retaining Retractors

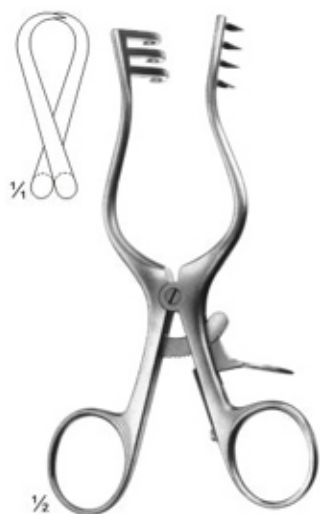

06-240
WEITLANER
sharp
130 mm

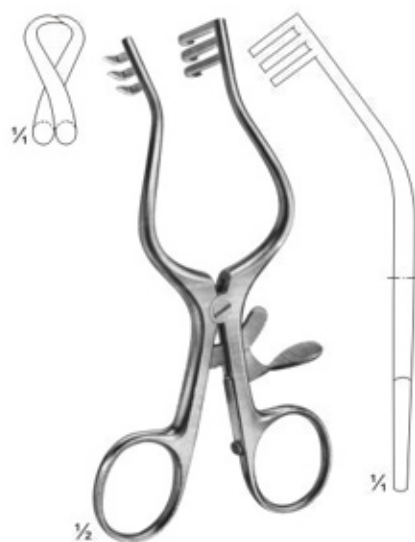

06-241
WULLSTEIN
sharp
130 mm

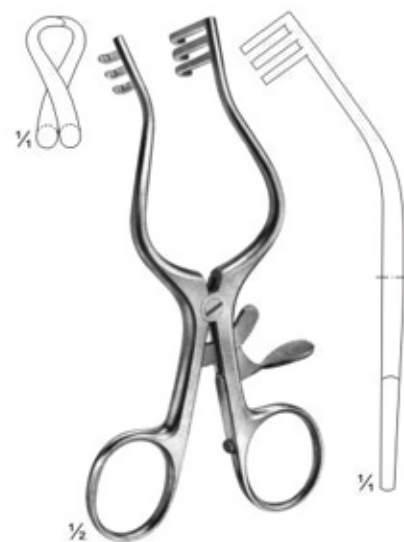

06-242
WULLSTEIN
blunt
130 mm



06-243
WEITLANER
sharp
165 mm



06-244
PLESTER
blunt
110 mm



06-245
PERKINS
130 mm

Special Retractors



1/2

06-246
JOLL (FRIEDMAN)
 Thyroid- and vaginal retractor
 155 mm

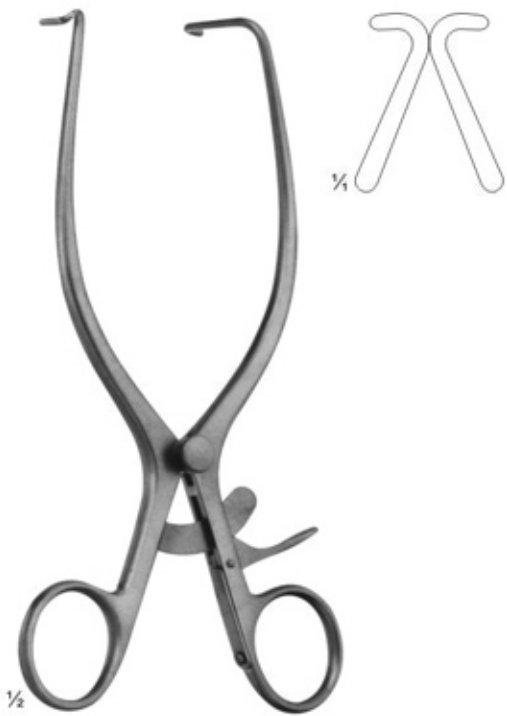

1/2

06-247
JACKSON BURROWS
 Retractor, blunt
 185 mm



1/4

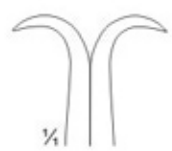

1/4



1/4



1/2

06-248
GELPI
 Vaginal retractor
 135 mm



1/2

06-249
GELPI
 Skin- and vaginal retractor
 175 mm



1/2

06-250
DE BAKEY
 Femur retractor
 145 mm

Lamina Spreaders



06-251
CLOWARD
155 mm



06-252
CLOWARD
135 mm



06-253
INGE
170 mm

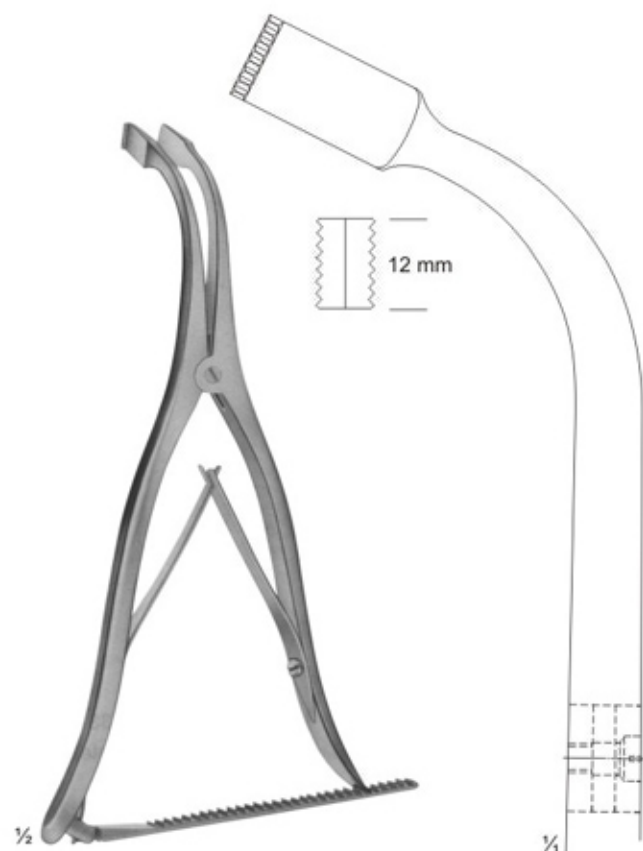

06-254
INGE
275 mm

Abdominal Retractors

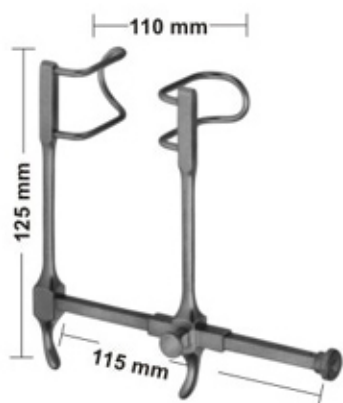

06-255
GOSSET
Blades:38 mm deep

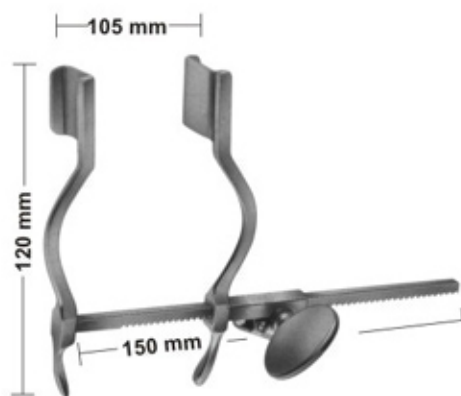

06-256
HERTZLER
Blades 20 X 25 mm

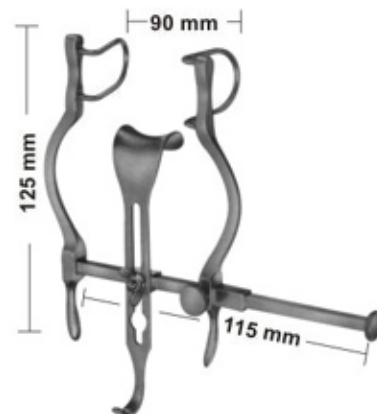

06-257
BALFOUR-BABY
Lateral blades 27 mm deep
Center blade 21x24 mm

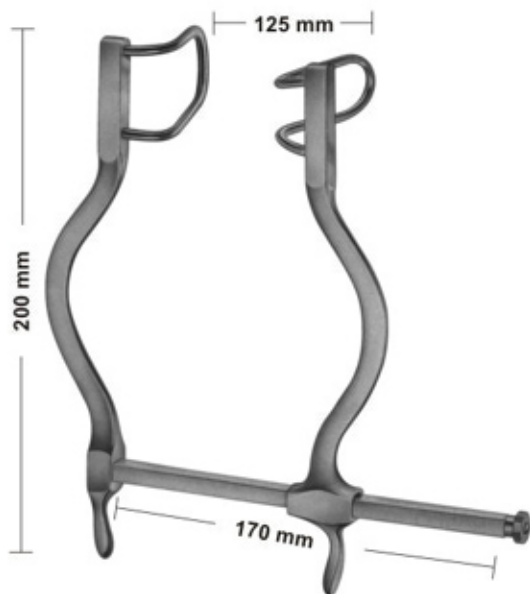

06-258
GOSSET
Blades:55mm deep

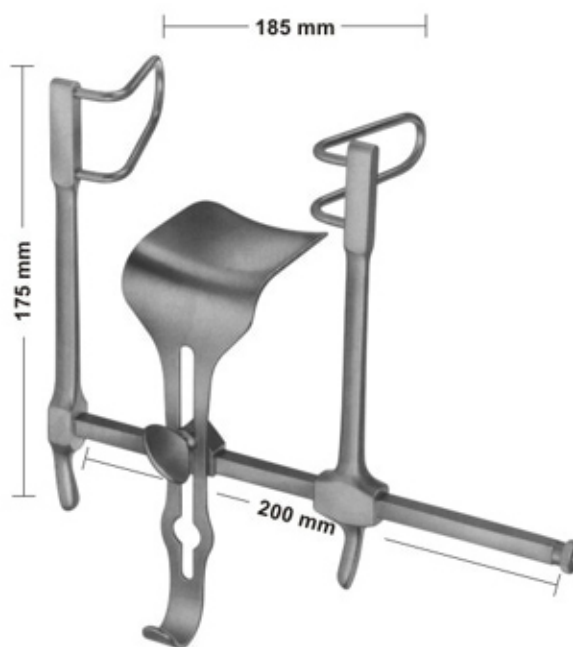

06-259
GOSSET
Lateral blades 58 mm deep
Center blade 59 x 57 mm

Abdominal Retractors

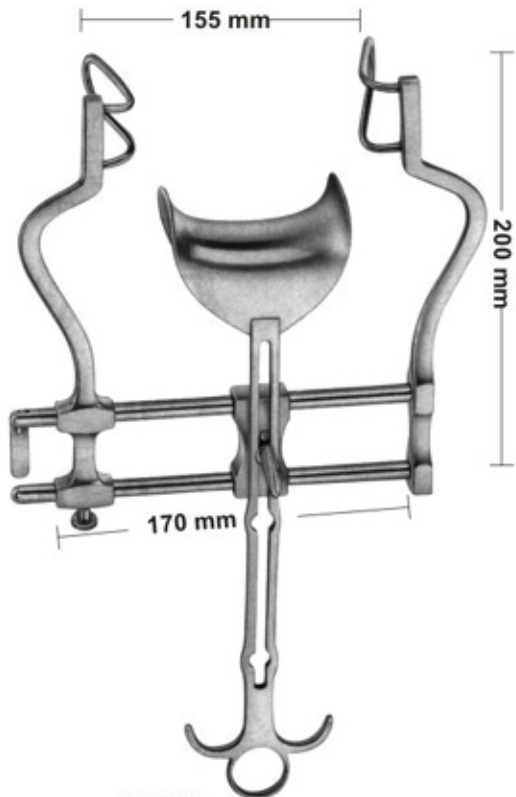

06-260
BALFOUR
Lateral blades 60 mm deep
Center blade 47 x 80 mm

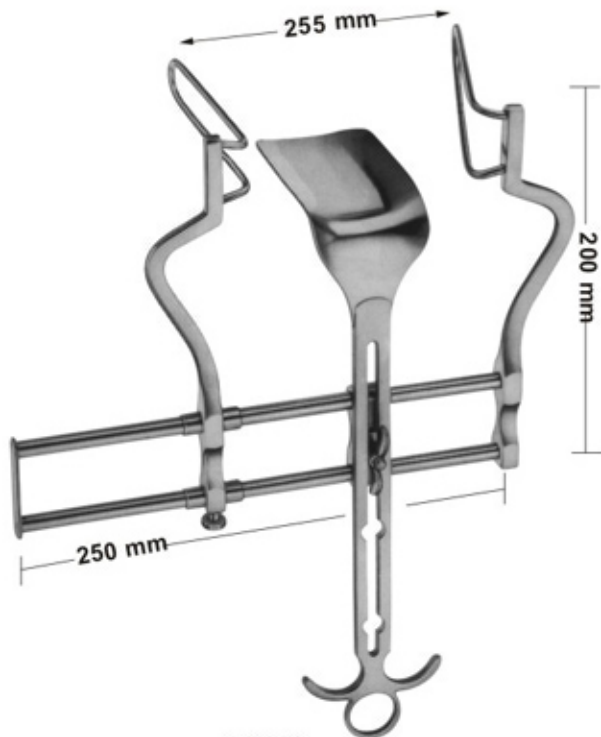

06-261
BALFOUR
Lateral blades 105 mm deep
Center blade 107x 59 mm



06-262
Center blade only
54x80 mm

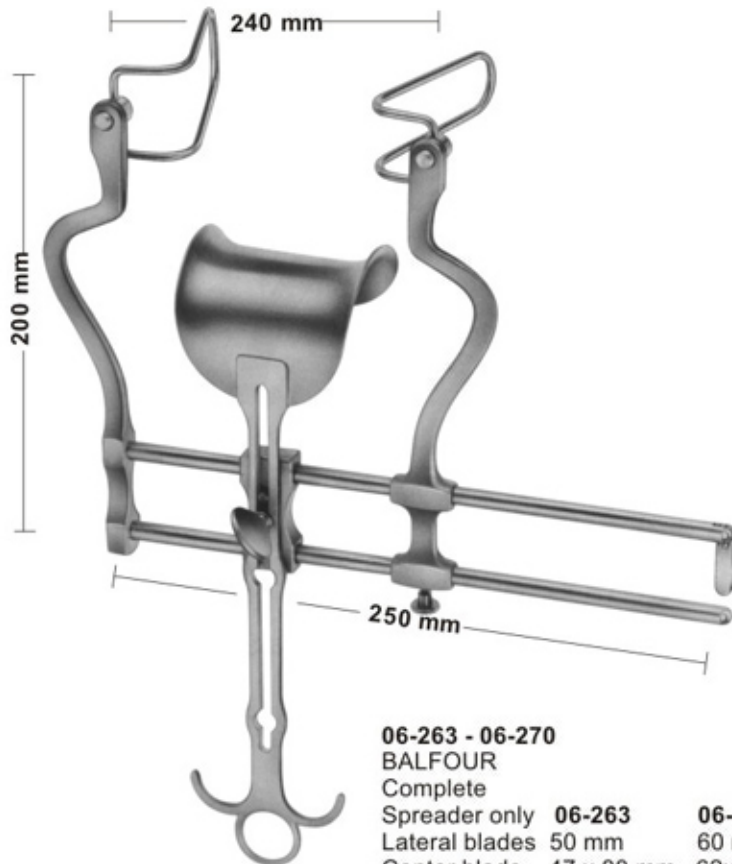

06-263 - 06-270
BALFOUR
Complete

Spreader only	06-263	06-264	06-265	06-266
Lateral blades	50 mm	60 mm	75 mm	90 mm
Center blade	47 x 80 mm	62x76 mm	80x80 mm	80x80 mm



Lateral blades
06-267 50 mm deep
06-268 60 mm deep
06-269 75 mm deep
06-270 90 mm deep
 Sales Unit of blades: PR = pair

Organ-, Tissue and Intestinal Grasping Forceps

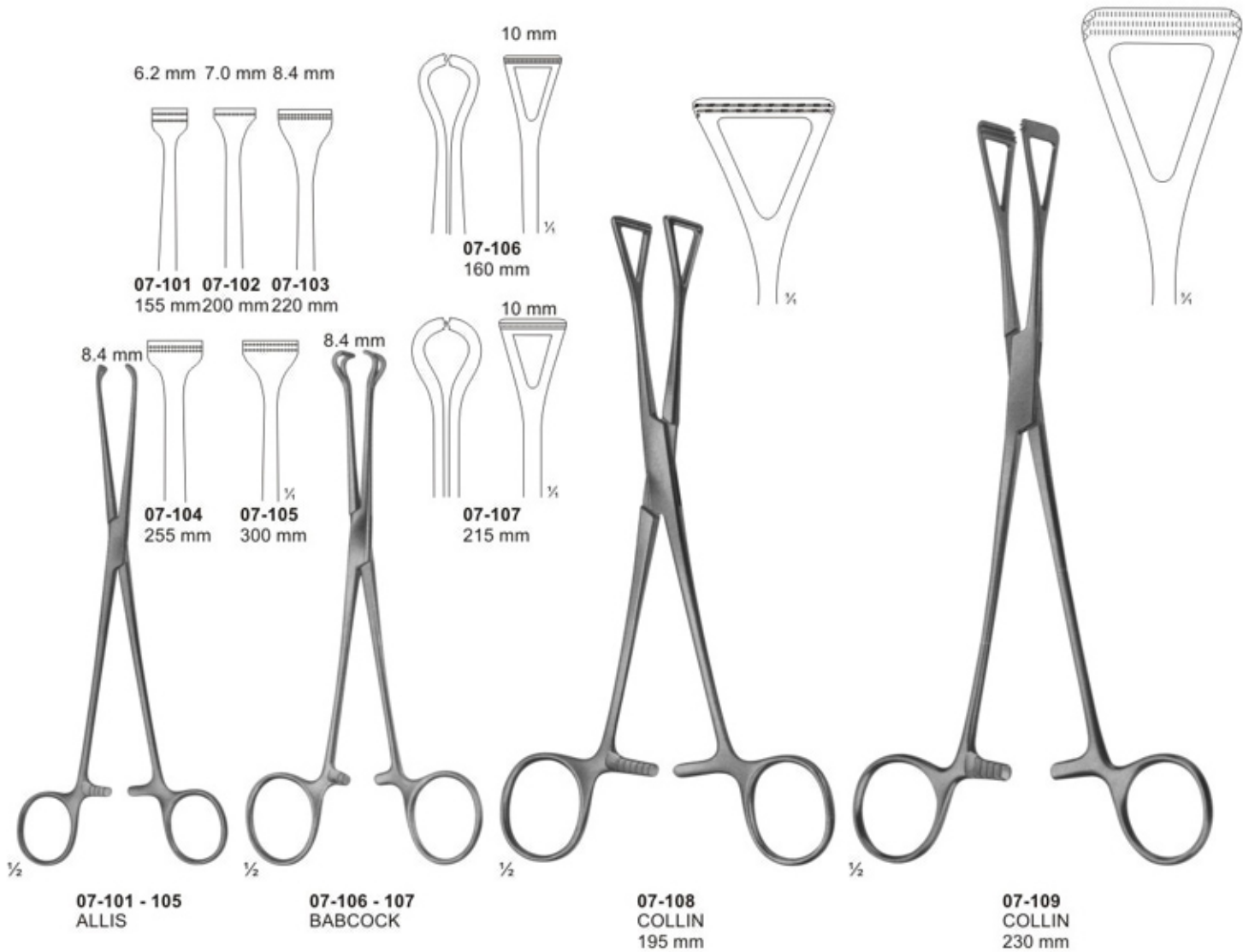

Intestinal Clamps, soft elastic

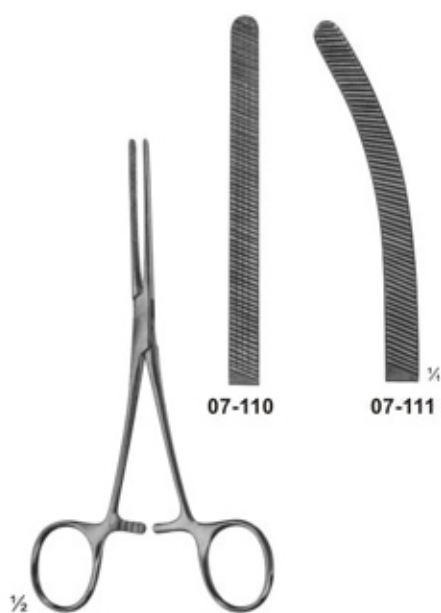

07-110 - 111
DOYEN
elastic
165 mm

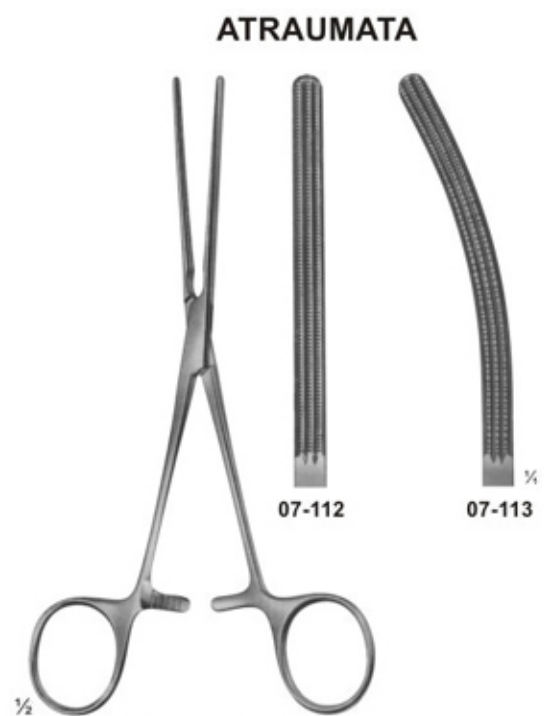

07-112 - 113
DOYEN
with elastic blades
170 mm

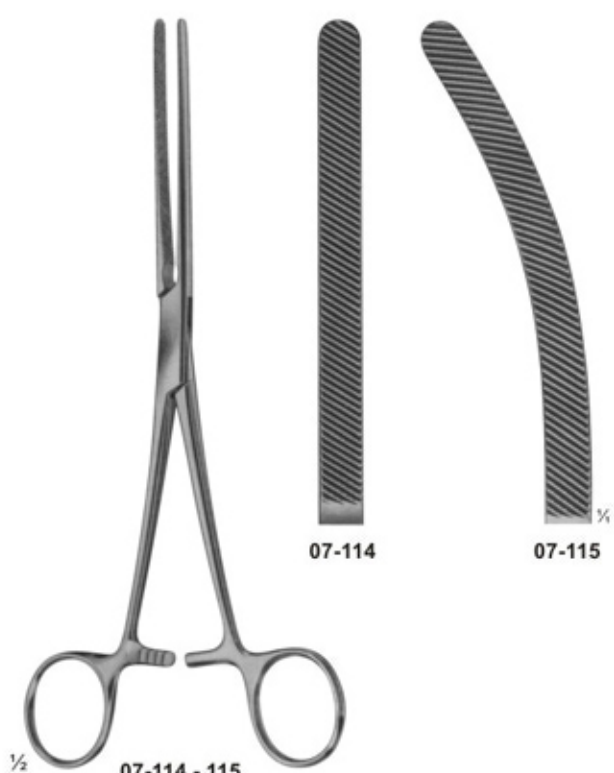

07-114 - 115
HARTMANN
with elastic blades
200 mm

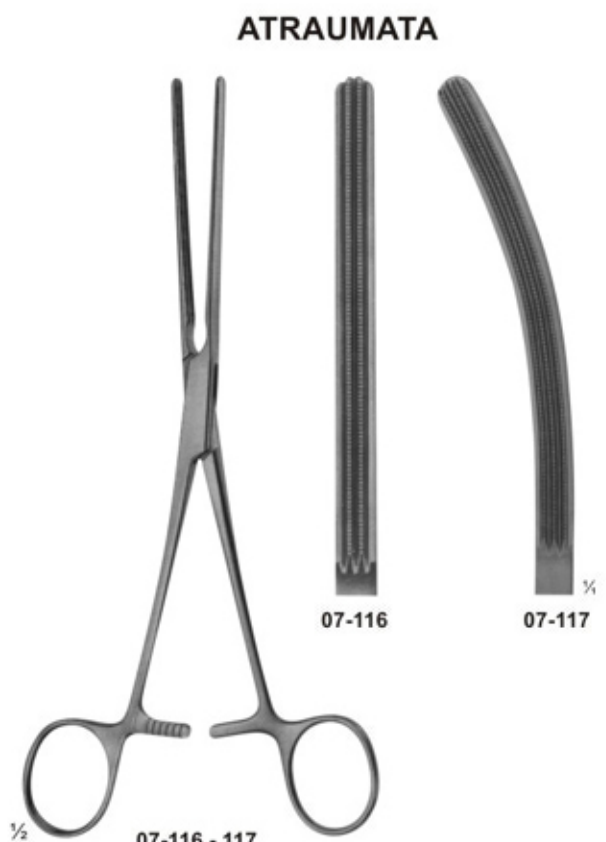

07-116 - 117
HARTMANN
with elastic blades
200 mm

Intestinal and Pylorus Clamps



07-118
PAYR
Intestinal clamp
light pattern,
for children
180 mm

07-119
PAYR
200 mm

07-120
PAYR
275 mm

07-121
PAYR
Pylorus clamp
315 mm

ATRAUMATA

Sigmoid Anastomosis Forceps

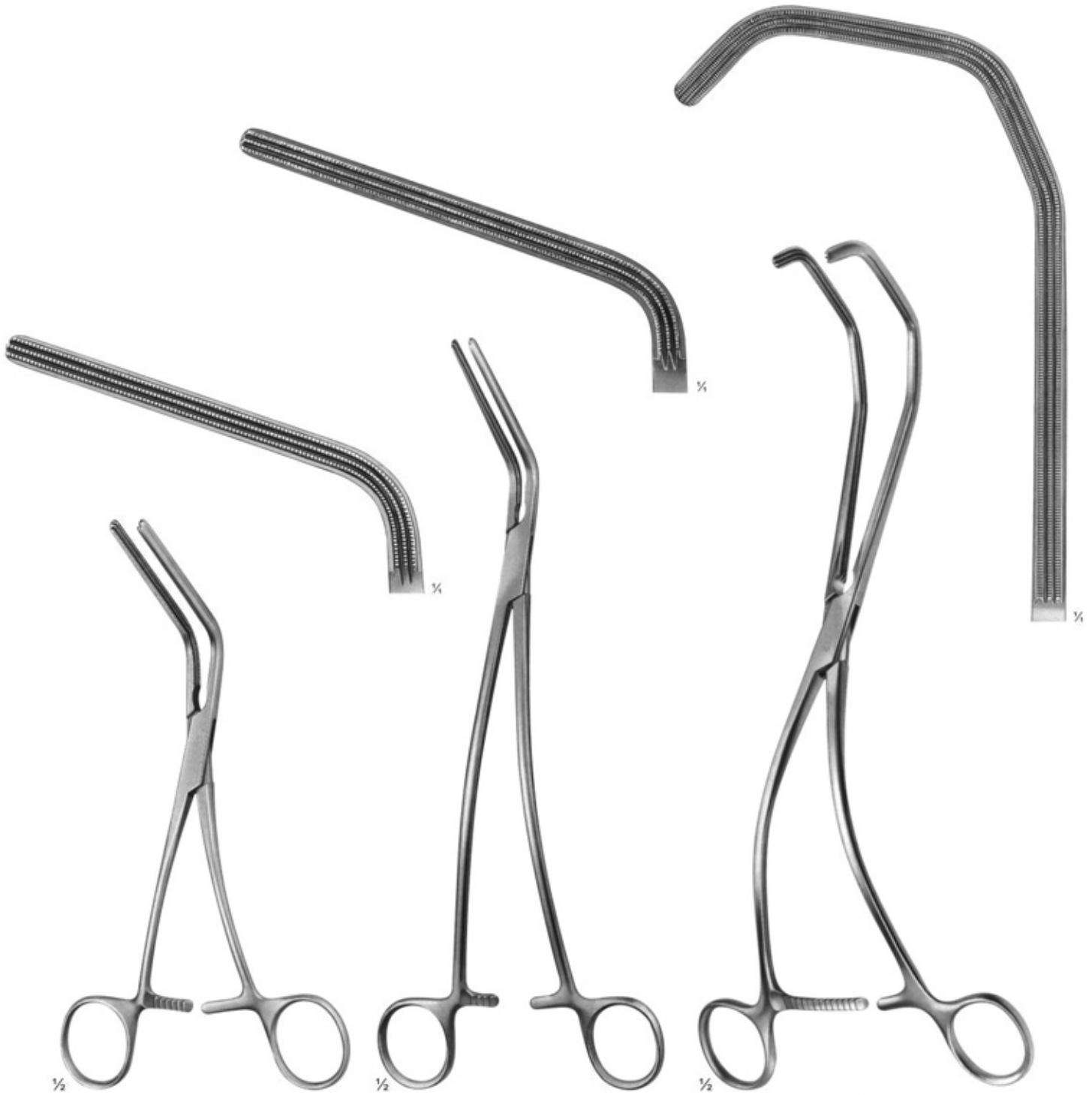

07-122
MORRIS
175 mm

07-123
DE BAKEY
(MORRIS modif.)
240 mm

07-124
KERSTING
270 mm

Nasal Specula



08-101
Martin
13 cm / 5 1/8"



08-102
SIMS
160 mm



08-103
Tieck-Halle
13 cm / 5 1/8"



08-104
Killian

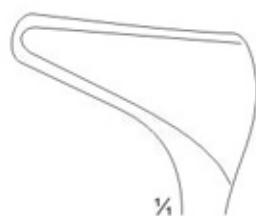

Fig. 1
14 cm 5 4/8"
35 mm

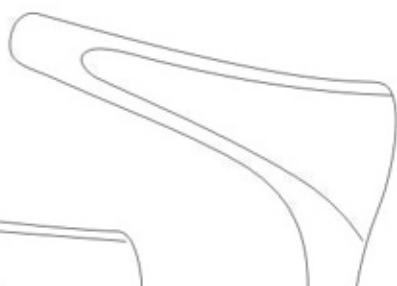

Fig. 2
14,5 cm / 5 4/8"
50 mm

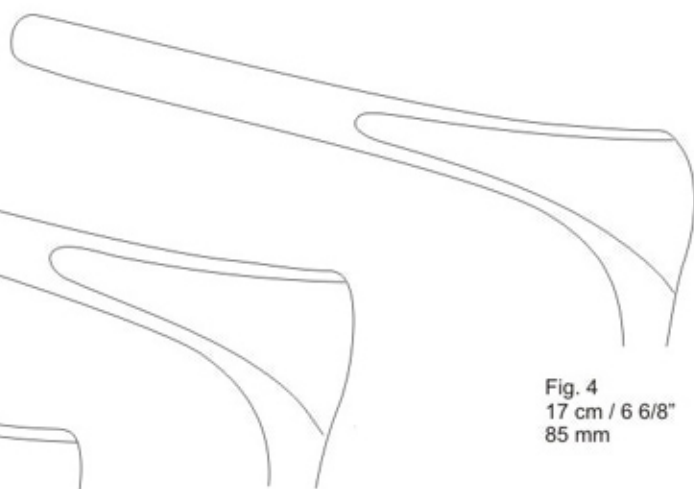

Fig. 3
16 cm / 6 2/8"
75 mm

Fig. 4
17 cm / 6 6/8"
85 mm

Nasal Specula



08-105
Cottle

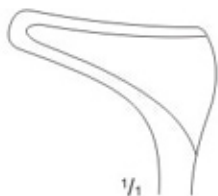

Fig. 1
13,5 cm / 5 3/8"
35 mm

1/1

Fig. 2
14 cm / 5 4/8"
50 mm

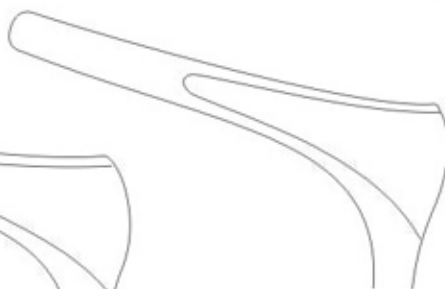

Fig. 3
16 cm / 6 2/8"
75 mm

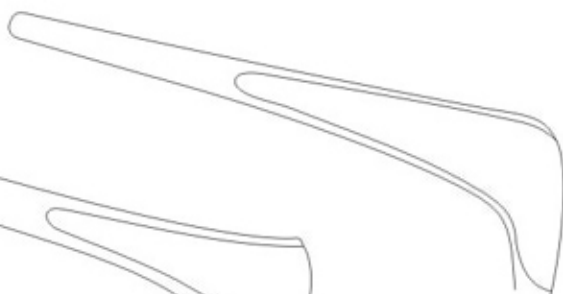

Fig. 4
16 cm / 6 2/8"
85 mm



08-106
Goldsmith (Thudichum)
6,5 cm / 2 4/8"



Fig. 1
21,0 x 9,5 mm



Fig. 2
21,0 x 10,5 mm



Fig. 3
21,0 x 11,5 mm



08-107
Mod. Wien 2
13,5 cm / 5 7/8"



Fig. 1
30 mm

1/1



08-108
Hartmann-Halle
16 cm / 6 7/8"



Fig. 1
27 mm



Fig. 2
31 mm



Fig. 3
35 mm

Anuscopes-Sphincteroscopes



08-109
IVES-FANSLER
Anuscops
145 mm
Ø24mm



08-110
KELLY
Sphincteroscope
160 mm
Ø21mm



08-111
KELLY
Sphincteroscope
160 mm
Ø27mm

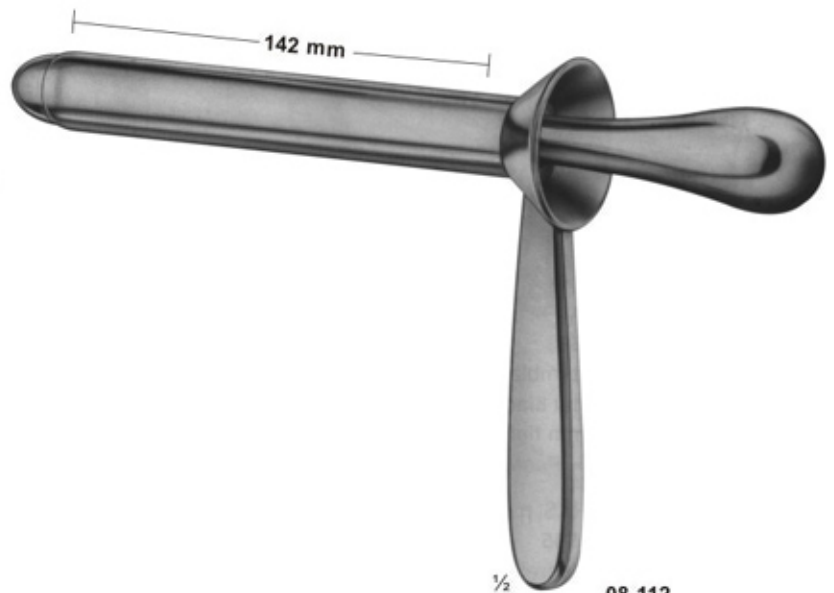

08-112
KELLY
Proctoscope
140 mm
Ø22mm

Haemorrhoidal Forceps

ATRAUMATA

Pressure Clamp

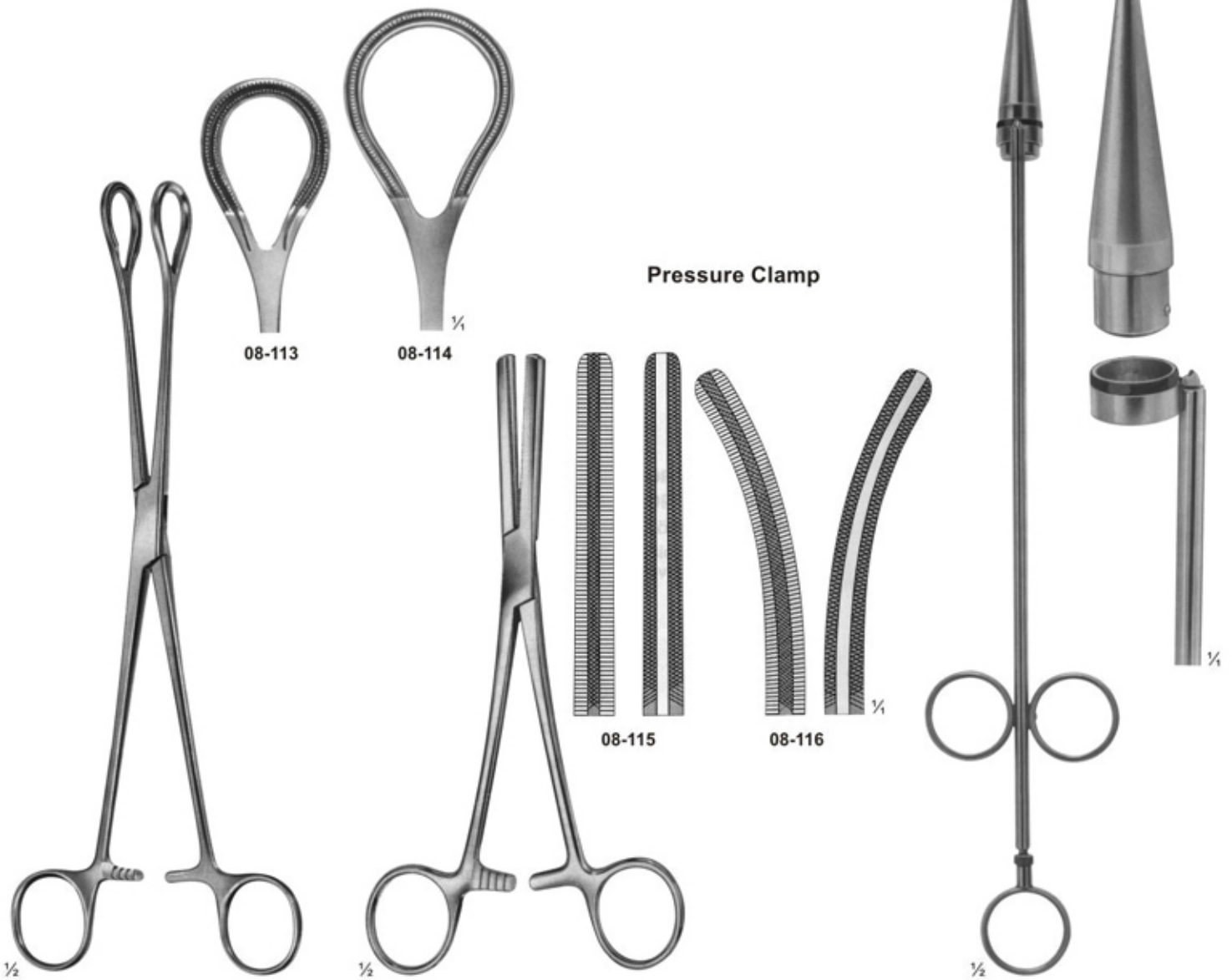

08-113 - 08-114
250 mm
08-114
270 mm

08-115 - 08-116
FERGUSSON
200 mm

08-117
RUDD
Haemorrhoidal ligator
with loading
attachment and 100
ligature rubber rings
315 mm

Gall Duct Forceps



08-118
LOWER
180 mm



08-119
LAHEY (SWEET)
190 mm



08-120
LAHEY
220 mm



08-121
DESJARDINS
Gall duct-and cystic forceps
210 mm



08-122
NISSEN
Gall duct-and cystic forceps
215 mm

Gall Duct Dilators and Gall Stone Scoops

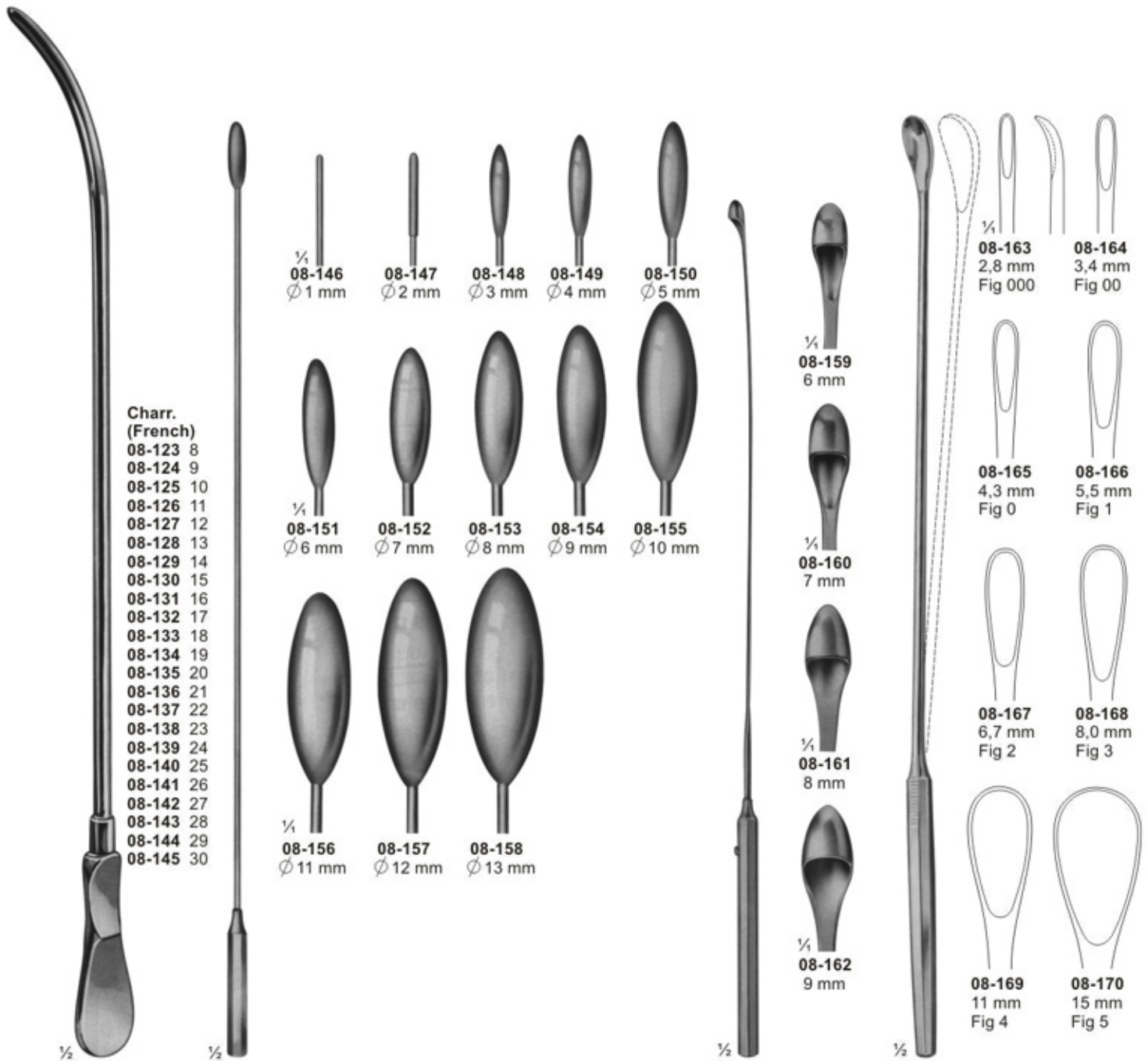

**Charr.
(French)**
 08-123 8
 08-124 9
 08-125 10
 08-126 11
 08-127 12
 08-128 13
 08-129 14
 08-130 15
 08-131 16
 08-132 17
 08-133 18
 08-134 19
 08-135 20
 08-136 21
 08-137 22
 08-138 23
 08-139 24
 08-140 25
 08-141 26
 08-142 27
 08-143 28
 08-144 29
 08-145 30

1/4
08-146
 Ø 1 mm

08-147
 Ø 2 mm

08-148
 Ø 3 mm

08-149
 Ø 4 mm

08-150
 Ø 5 mm

1/4
08-151
 Ø 6 mm

08-152
 Ø 7 mm

08-153
 Ø 8 mm

08-154
 Ø 9 mm

08-155
 Ø 10 mm

1/4
08-156
 Ø 11 mm

08-157
 Ø 12 mm

08-158
 Ø 13 mm

1/4
08-159
 6 mm

1/4
08-160
 7 mm

1/4
08-161
 8 mm

1/4
08-162
 9 mm

1/4
08-163
 2,8 mm
 Fig 000

08-164
 3,4 mm
 Fig 00

08-165
 4,3 mm
 Fig 0

08-166
 5,5 mm
 Fig 1

08-167
 6,7 mm
 Fig 2

08-168
 8,0 mm
 Fig 3

08-169
 11 mm
 Fig 4

08-170
 15 mm
 Fig 5

08-123 - 08-145
DITTEL
 Metall bougies and
 dilating sounds, stiff
 345 mm

08-146 - 08-158
BAKES
 Common bile duct
 dilators, malleable
08-146 - 08-150 315 mm
08-151 - 08-158 320 mm

08-159 - 08-162
DESJARDINS
 Probe and catch
 with flexible schaft
 300 mm

08-163 - 08-170
LUER-KOERTE modif
 with malleable shaft
 310 mm

Gall Stone Forceps

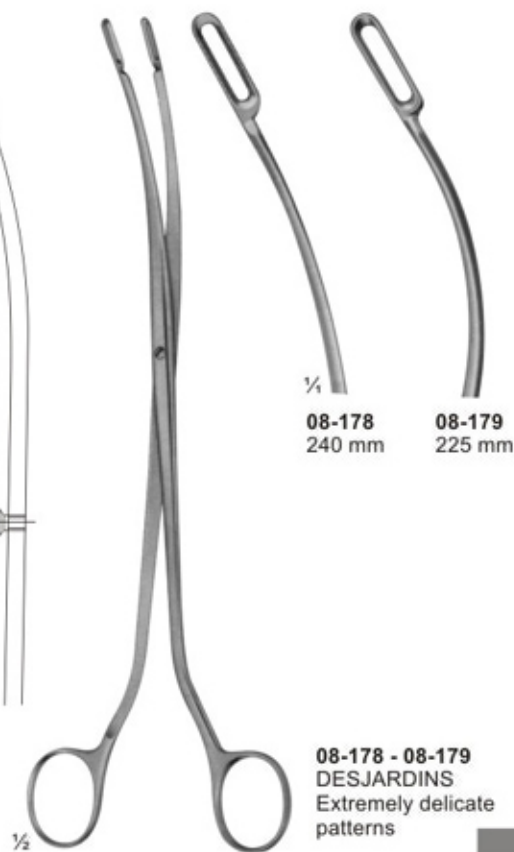
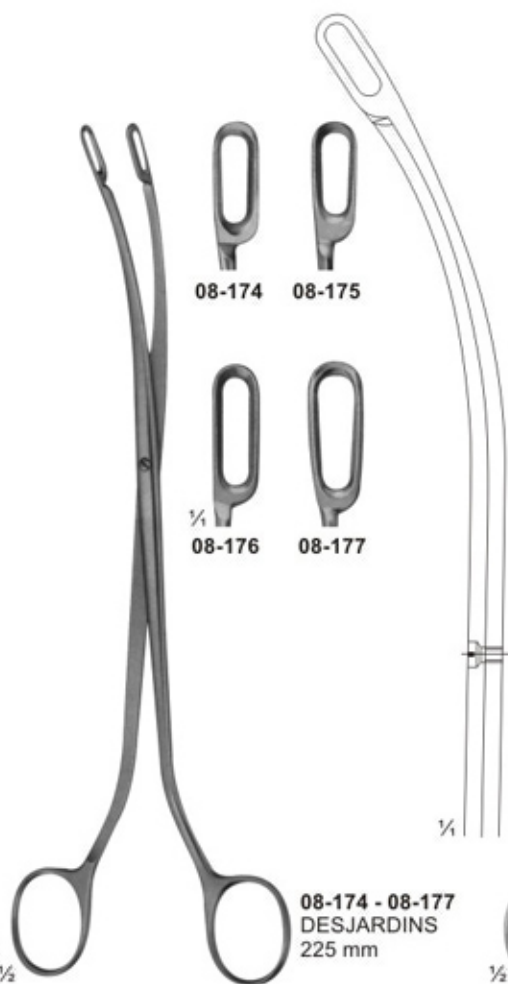
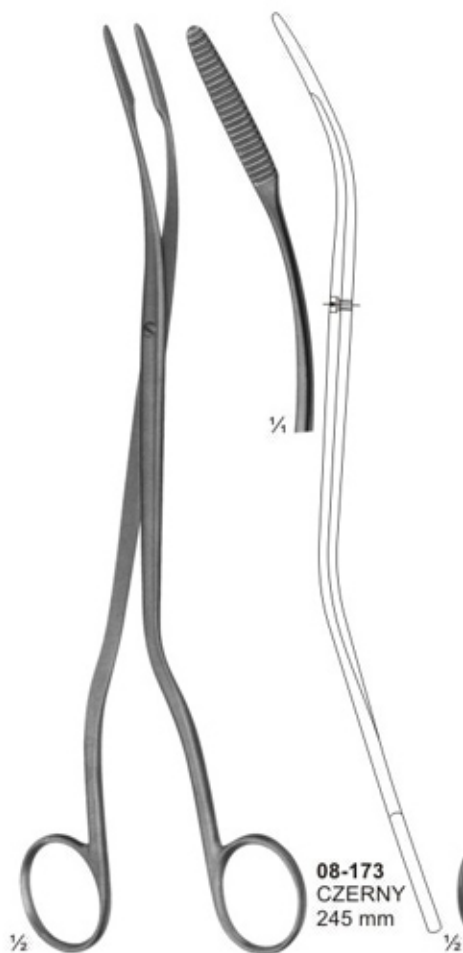
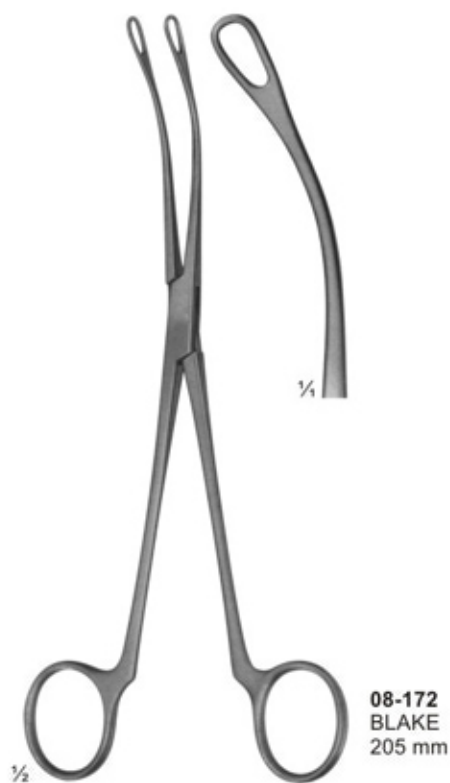

Kidney Clamps

ATRAUMATA

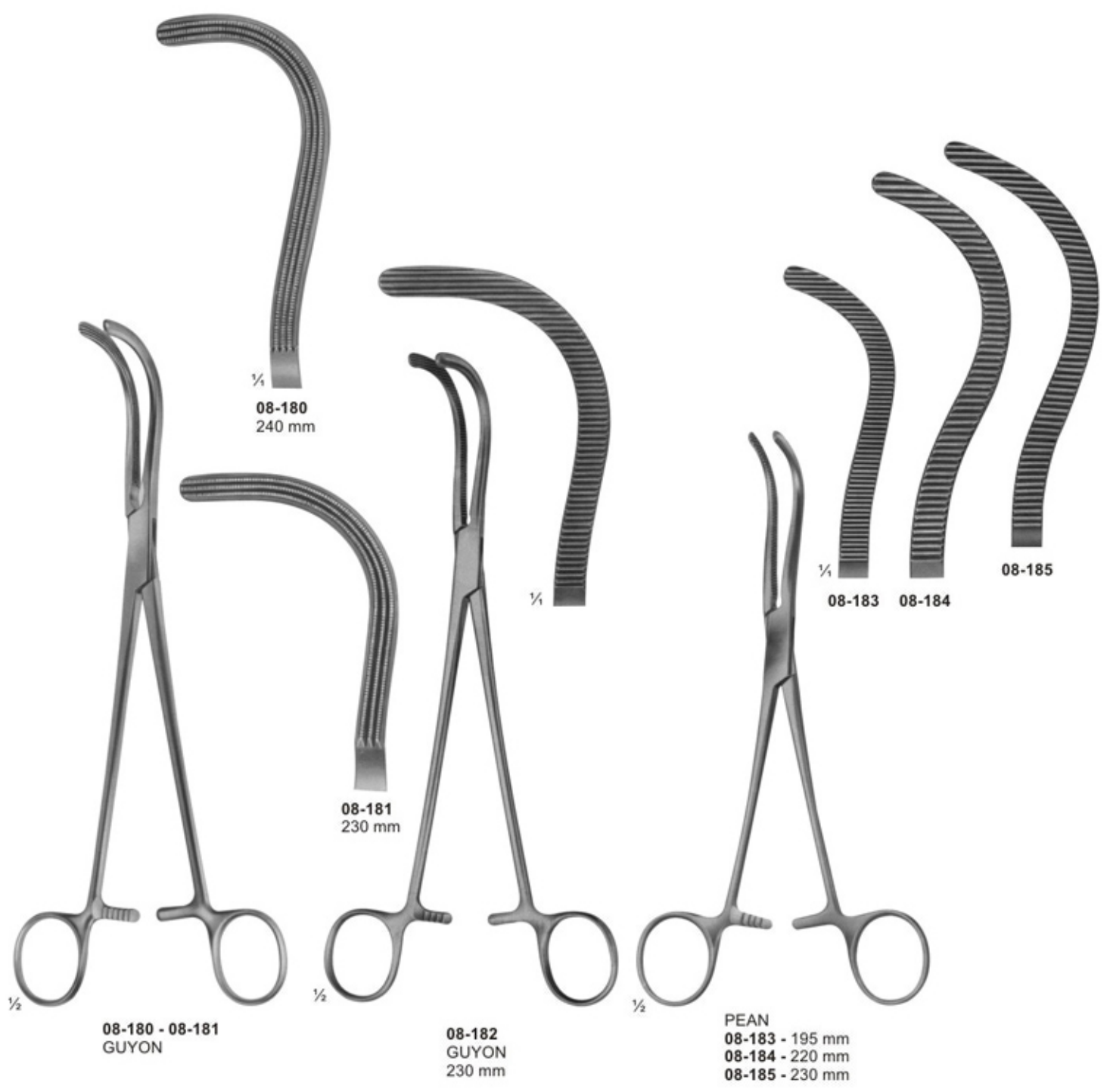

Kidney Stone Forceps



08-186



08-187



08-188



1/4
08-189



08-190



08-191



1/4
08-192



1/2

08-186 - 08-189
RANDALL
225 mm



1/2

08-190 - 08-192
RANDALL
190 mm

Bladder Retractors

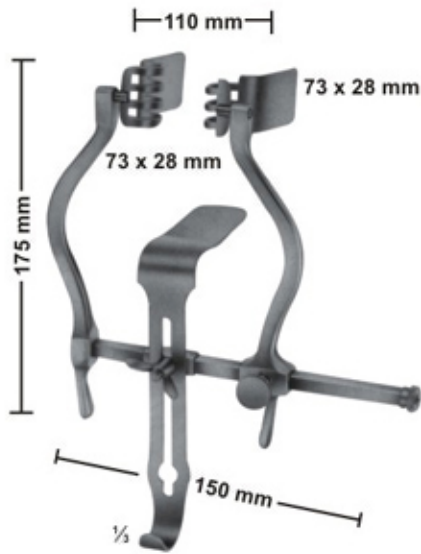

09-101
JUDD-MASSON
Bladder-and suprapubic
retractor

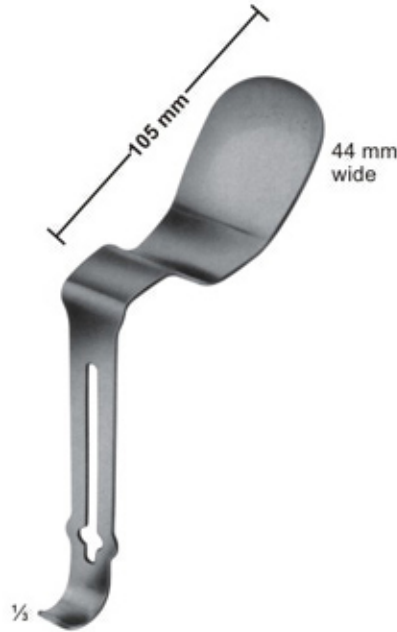

09-102
MILLIN
Center bladder for
retro pubic prostatectomy



09-103
MILLIN
Bladder retractor, complete
105X45 mm



09-104
LEGUEU
Bladder retractor
Center blade
80 x 31 mm



09-105
KOCHER
Bladder spatula
235 mm

Trocars



09-106
KLIMA ROSEGGER
35 X 1,8 mm
Sternal puncture needle



09-107
Universal trocar
with 4 tips



NELSON



09-108 - 112
Inside diam. Outside diam
09-108 2,2 mm 3,0 mm
09-109 3,0 mm 4,0 mm
09-110 4,0 mm 5,0 mm
09-111 5,0 mm 6,0 mm
09-112 5,5 mm 6,5 mm
for hydrocele and abdominal
puncture

09-113 - 116
Inside dime. Outside dime
09-113 2,2 mm 3,0 mm
09-114 3,0 mm 4,0 mm
09-115 4,0 mm 5,0 mm
09-116 5,0 mm 6,0 mm
for abdominal puncture,
with stop-cock and lateral
drain



09-117 - 118
Inside diam. Outside diam
09-117 6,5 mm 8,0 mm
09-118 9,0 mm 10,0 mm
Empyema trocar
BUELEU

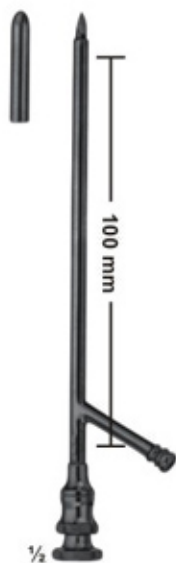

09-119 - 122
Inside diam. Outside diam
09-119 3,0 mm 4,0 mm
09-120 3,6 mm 4,6 mm
09-121 4,3 mm 5,3 mm
09-122 5,0 mm 6,0 mm
Gall bladder trocars. OCHSNER



09-123
PIERCE
Antrum trocar
Ø 4,0 mm



09-124
COAKLEY
Antrum trocar
3,0 mm

Vaginal Specula



10-101
COLLIN
for children
53 x 10 mm

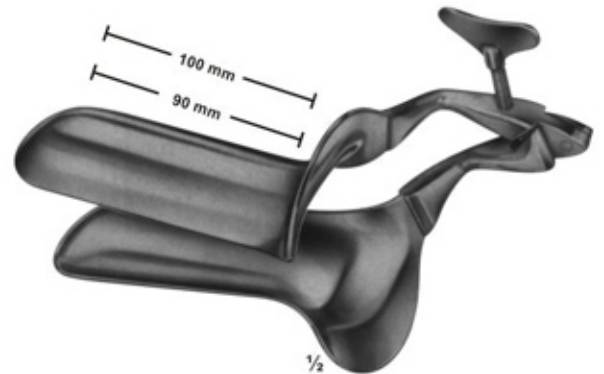

10-102 - 105
COLLIN

10-102	100/90mm	28 mm
10-103	100/90mm	32 mm
10-104	105/95mm	35 mm
10-105	115/105mm	40 mm
Total length/working length		width



10-106
COLLIN
for virgins
95/85 x 18 mm



10-107
CUSCO
for virgins
75 x 17 mm



10-108
CUSCO
for virgins
75 x 17 mm

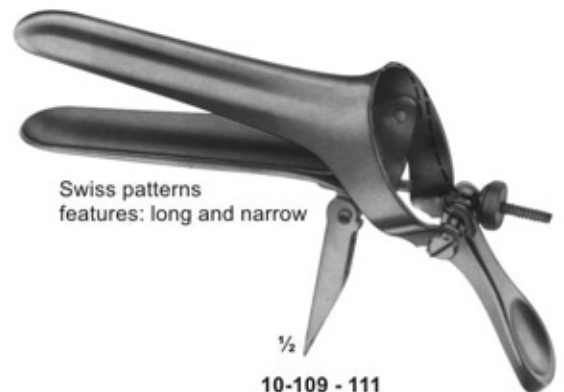

Swiss patterns
features: long and narrow

10-109 - 111
CUSCO

10-109	92X23-25 mm
10-110	100x25-27 mm
10-111	110x27-30 mm

Vaginal Specula- Sets, upper and lower blades



10-112 - 114
GRAVE
10-112 75X20 mm
10-113 95X30 mm
10-114 105X33 mm

½



10-115 - 116
PEDERSON
10-115 100X22 mm
10-116 120X25 mm

½



10-117 - 118
BRIESKY
10-117 72X25 mm / 77X30 mm 140 mm
10-118 75X30 mm / 92X38 mm 170 mm

½



10-119
SIMS
70 X 26 mm / 75 X 30 mm
75 X 30 mm / 80 X 35 mm
80 X 36 mm / 90 X 40 mm
175 mm

½



10-120 - 122
SEIDL
10-120 80X8 mm
10-121 80X10 mm
10-122 90X14 mm
For children and infants
170 mm

½



10-123
KRISTELLER
70X15 mm, (170 mm)
For children

½



10-124 - 10-126
KRISTELLER
10-124 70X27 mm
10-125 75X30 mm
10-126 90X36 mm
175 mm

½

Vaginal Specula- upper and lower blades



10-127 - 131
KRISTELLER
10-127 110X18 mm
10-128 110X20 mm
10-129 110X27 mm
10-130 110X30 mm
10-131 110X36 mm
220 mm

10-132 - 10-135
KRISTELLER
Upper blades

10-136 - 10-139
KRISTELLER
Lower blades

Vaginal Specula



Vaginal Retractors



1/2
10-154
JOLL (FRIEDMAN)
155 mm



1/2
10-155
RICHTER
170 mm



1/2
10-156
GELPI
135 mm



1/2
10-157
GELPI
175 mm

Uterine Dilators



11-101 - 143
HEGAR
with very conical point
185 mm

11-101	1	mm	11-123	23	mm
11-102	2	mm	11-124	24	mm
11-103	3	mm	11-125	25	mm
11-104	4	mm	11-126	26	mm
11-105	5	mm	11-127	1	½mm
11-106	6	mm	11-128	2	½mm
11-107	7	mm	11-129	3	½mm
11-108	8	mm	11-130	4	½mm
11-109	9	mm	11-131	5	½mm
11-110	10	mm	11-132	6	½mm
11-111	11	mm	11-133	7	½mm
11-112	12	mm	11-134	8	½mm
11-113	13	mm	11-135	9	½mm
11-114	14	mm	11-136	10	½mm
11-115	15	mm	11-137	11	½mm
11-116	16	mm	11-138	12	½mm
11-117	17	mm	11-139	13	½mm
11-118	18	mm	11-140	14	½mm
11-119	19	mm	11-141	15	½mm
11-120	20	mm	11-142	16	½mm
11-121	21	mm	11-143	17	½mm
11-122	22	mm			



11-144 - 152
HEGAR
205 mm

11-144	1+2	mm
11-145	3+4	mm
11-146	5+6	mm
11-147	7+8	mm
11-148	9+10	mm
11-149	11+12	mm
11-150	13+14	mm
11-151	15+16	mm
11-152	17+18	mm

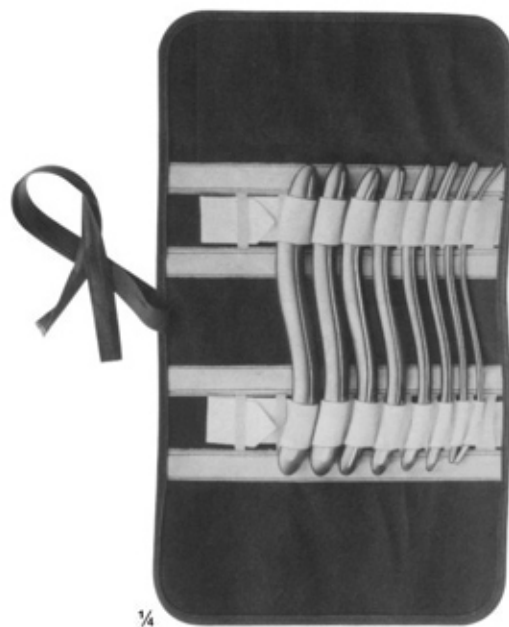

11-153
HEGAR
Uterine dilator set, in canvas
roll with 8 dilators.

Uterine Probes

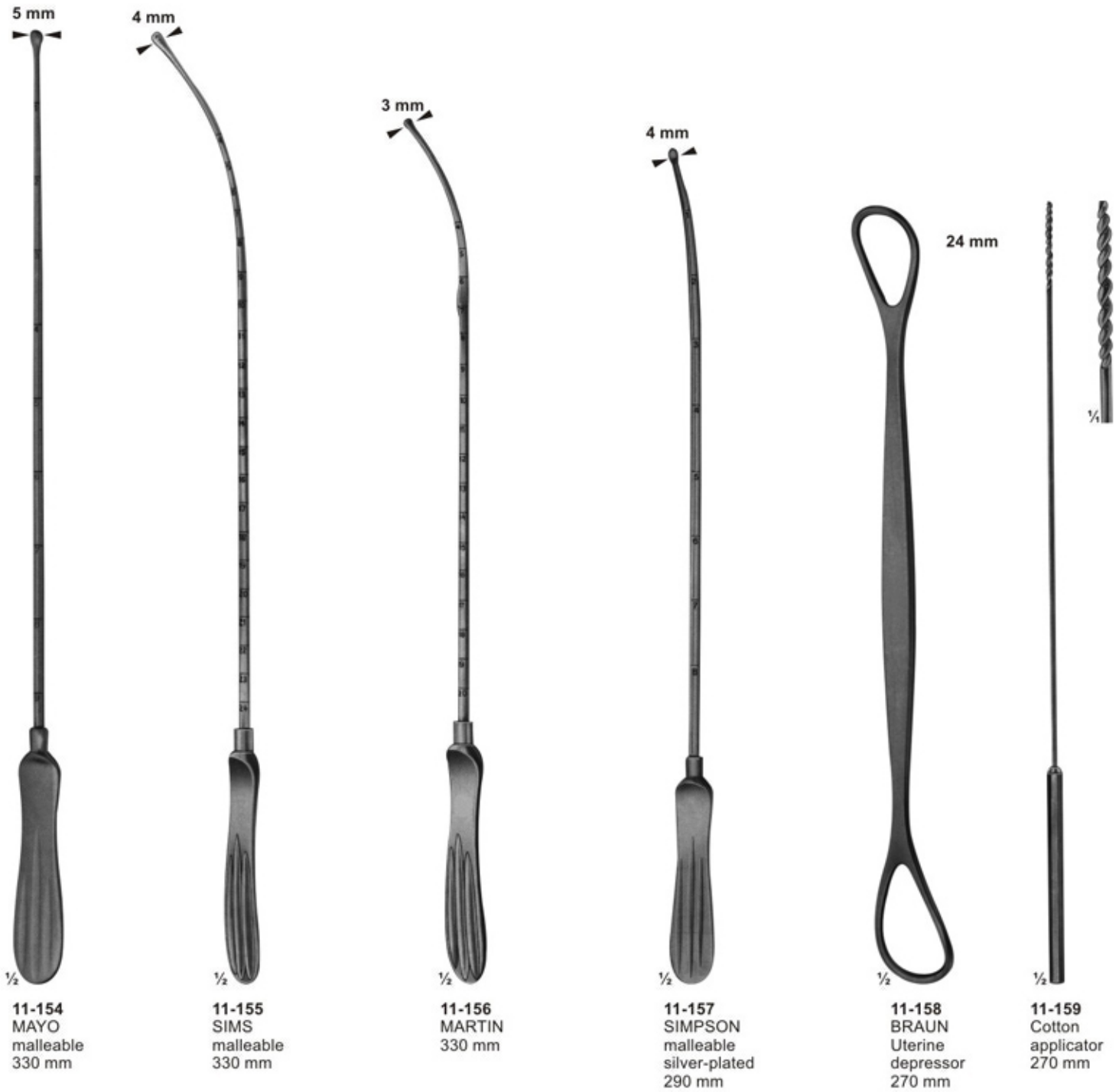

Uterine Dressing Forceps



11-160
PELKMANN
260 mm



11-161
PELKMANN
260 mm

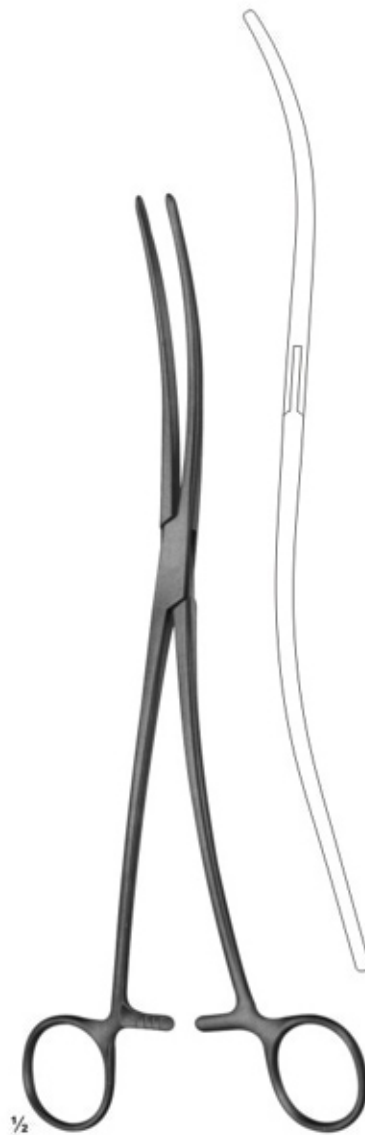

11-162
BOZEMANN
250 mm



11-163
BOZEMANN
255 mm

Jaws with longitudinal groove

Polypus-and Ovum Forceps

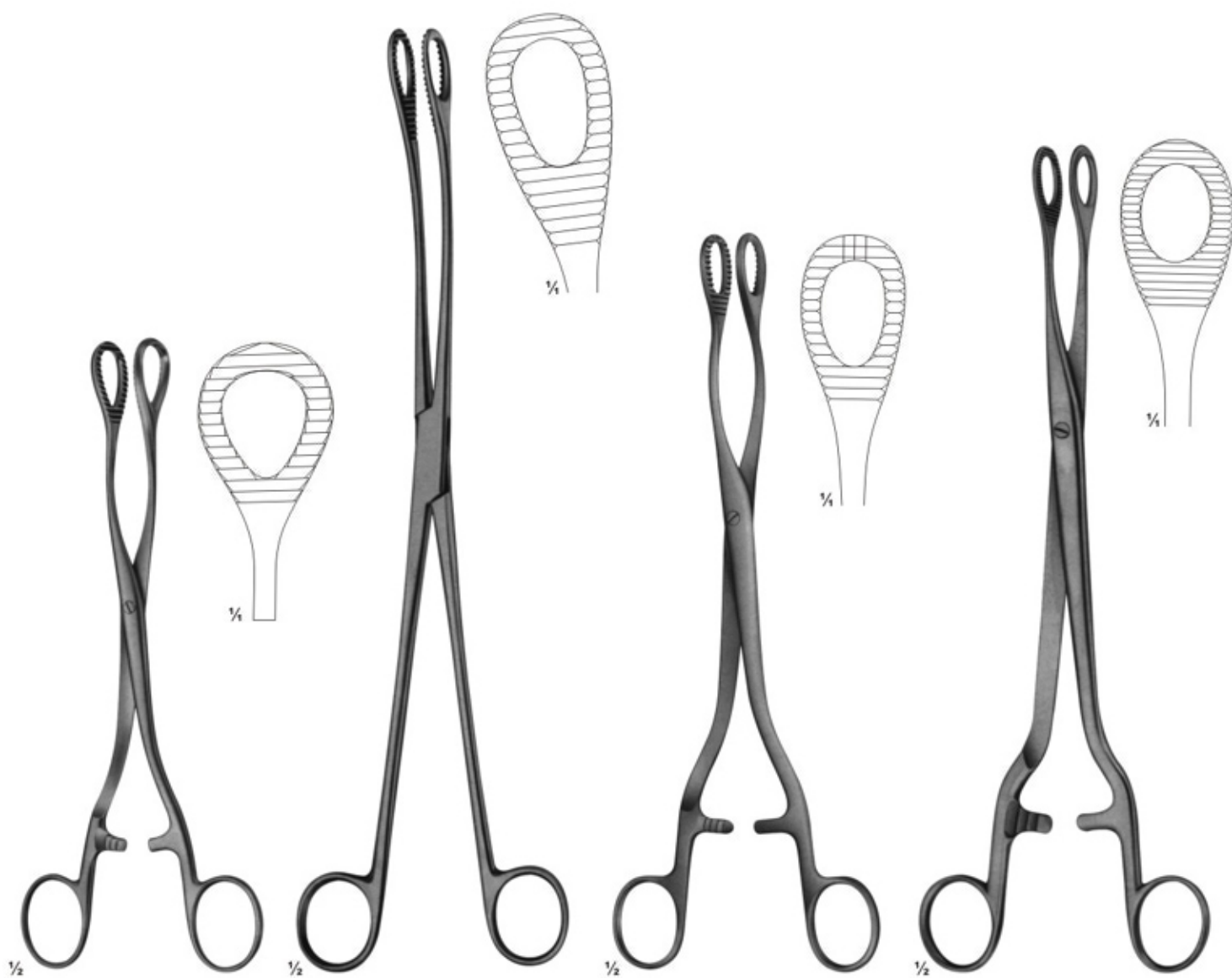

11-164
HEYWOOD-SMITH
200 mm

11-165
KELLY
320 mm

11-166
HEYWOOD-SMITH
250 mm

11-167
NOTO
280 mm

Ear Curettes



12-101
Langenbeck
13 cm / 5 1/8"

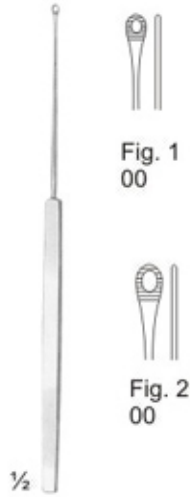

12-102
Shapleigh
15 cm / 5 1/8"

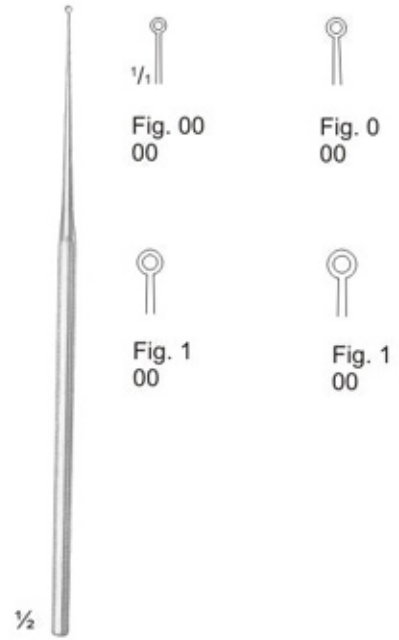

12-103
Buck
17cm / 6 6/8"



12-104
Buck
15 cm / 6 6/8"

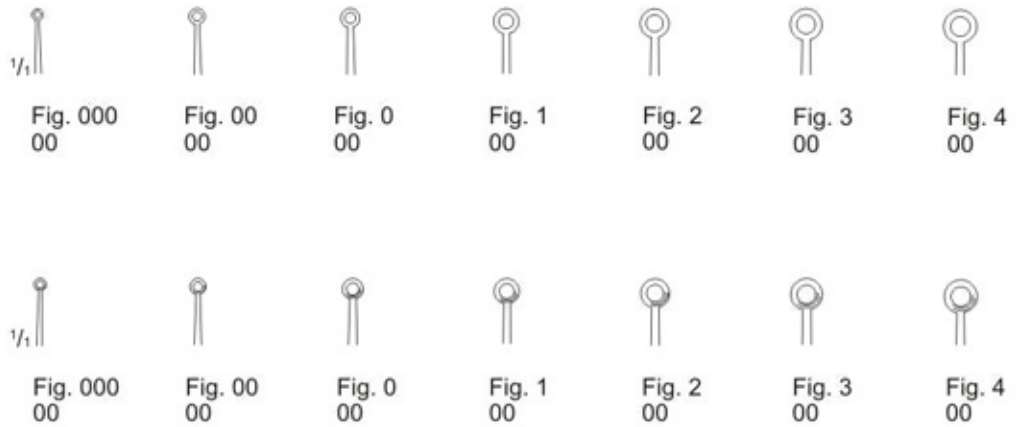

Biopsy Currettes

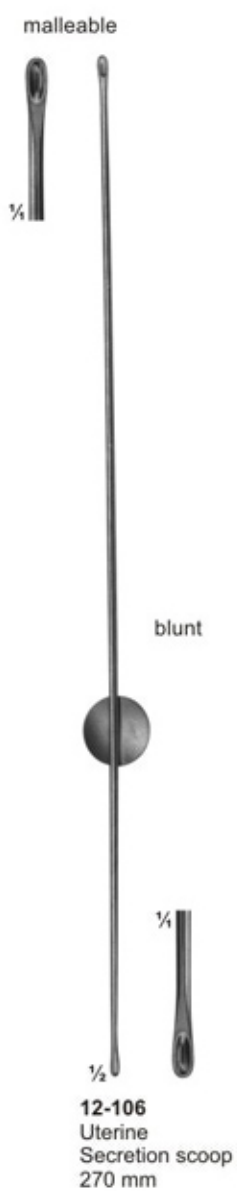
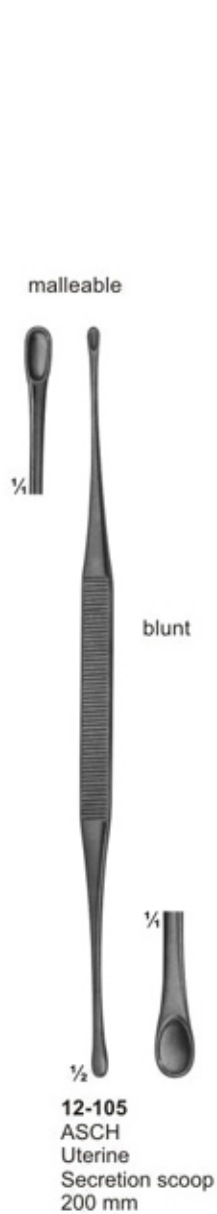

Ear Polypus Forceps



12-109
Hartmann-Wullstein
shaft length
85 mm



12-110
Hartmann-Wullstein
shaft length
85 mm



12-111
Hartmann
shaft length
85 mm



12-112
Hartmann
shaft length
85 mm



$\frac{1}{2}$
12-109 - 12-119

12-113
14 cm / 5 4/8"
shaft length
140 mm



$\frac{1}{4}$
12-114
Hartmann-Herzfelr
2,0 mm
shaft length
85mm



12-115
Hartmann
3 mm
shaft length
85mm

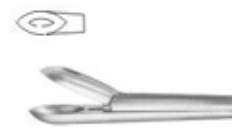

12-116
shaft length
85mm

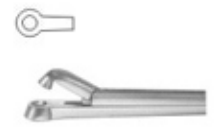

12-117
Hartmann-Hoffmar
2,0 mm
85mm

12-118
2,5 mm
85 mm

12-119
3,0 mm
85 mm

Biopsy forceps for rectum

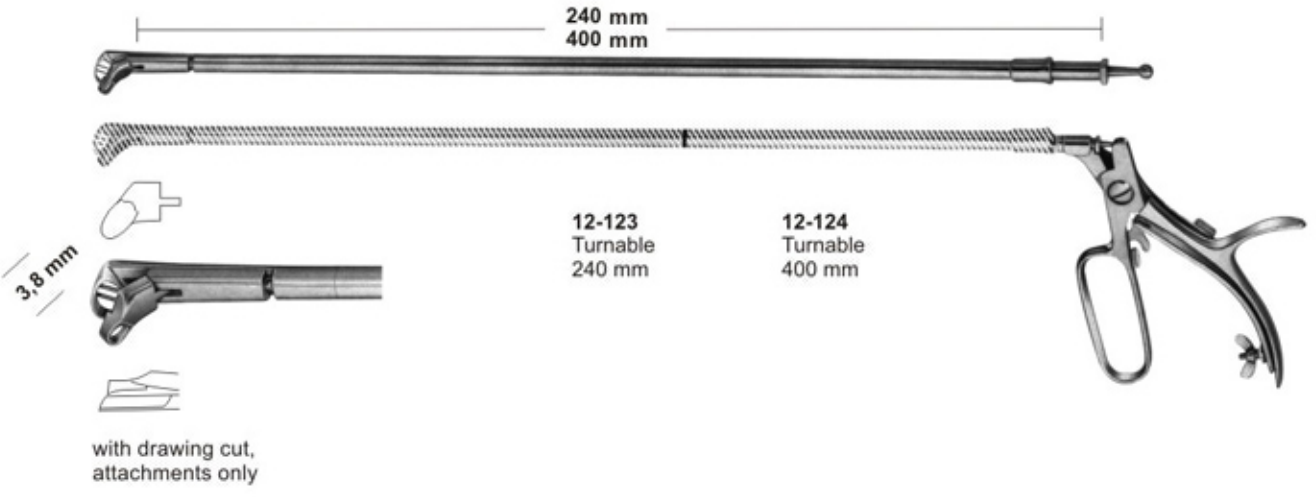
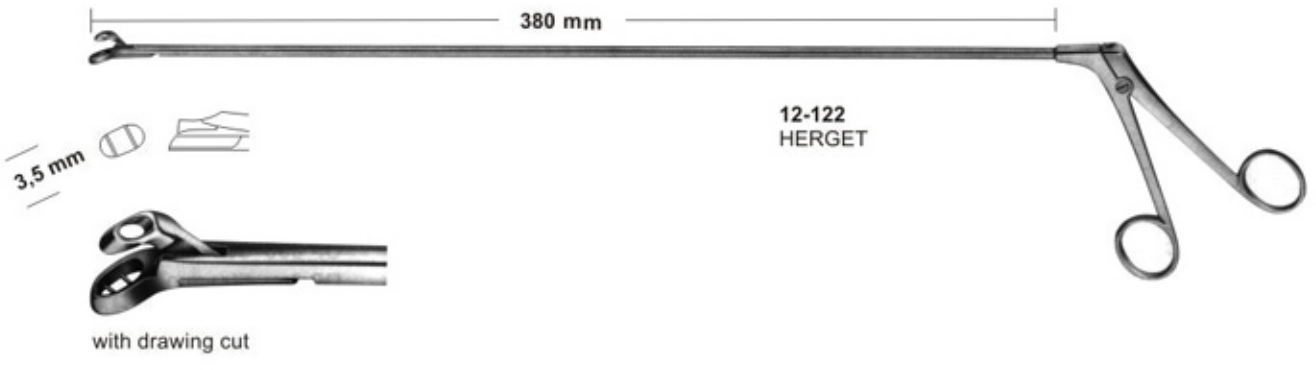
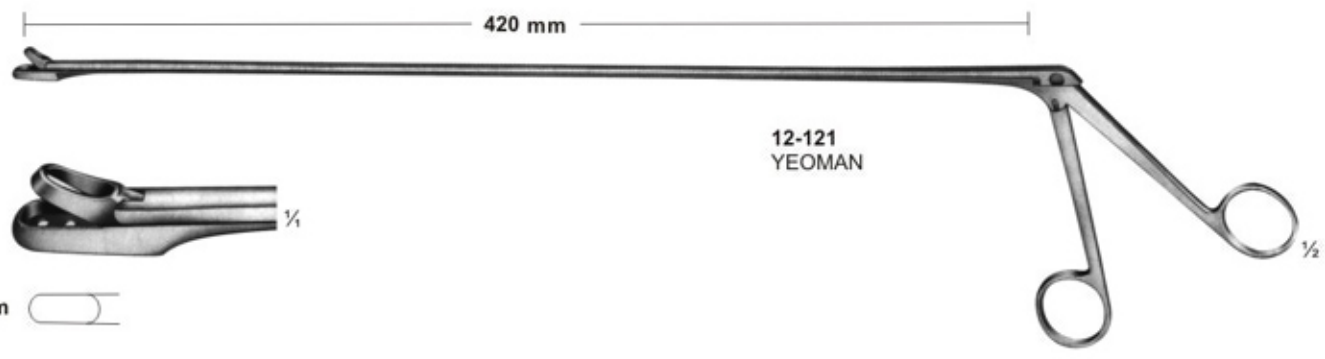
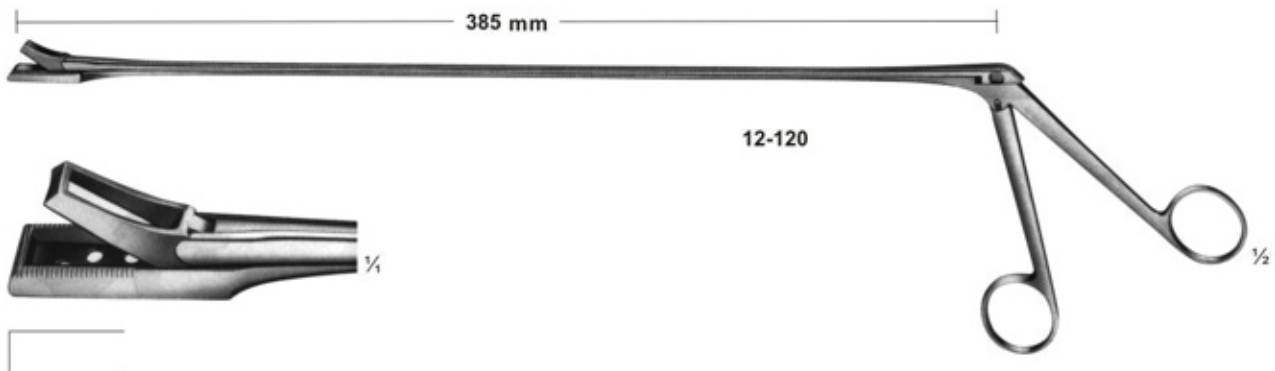

Biopsy Forceps

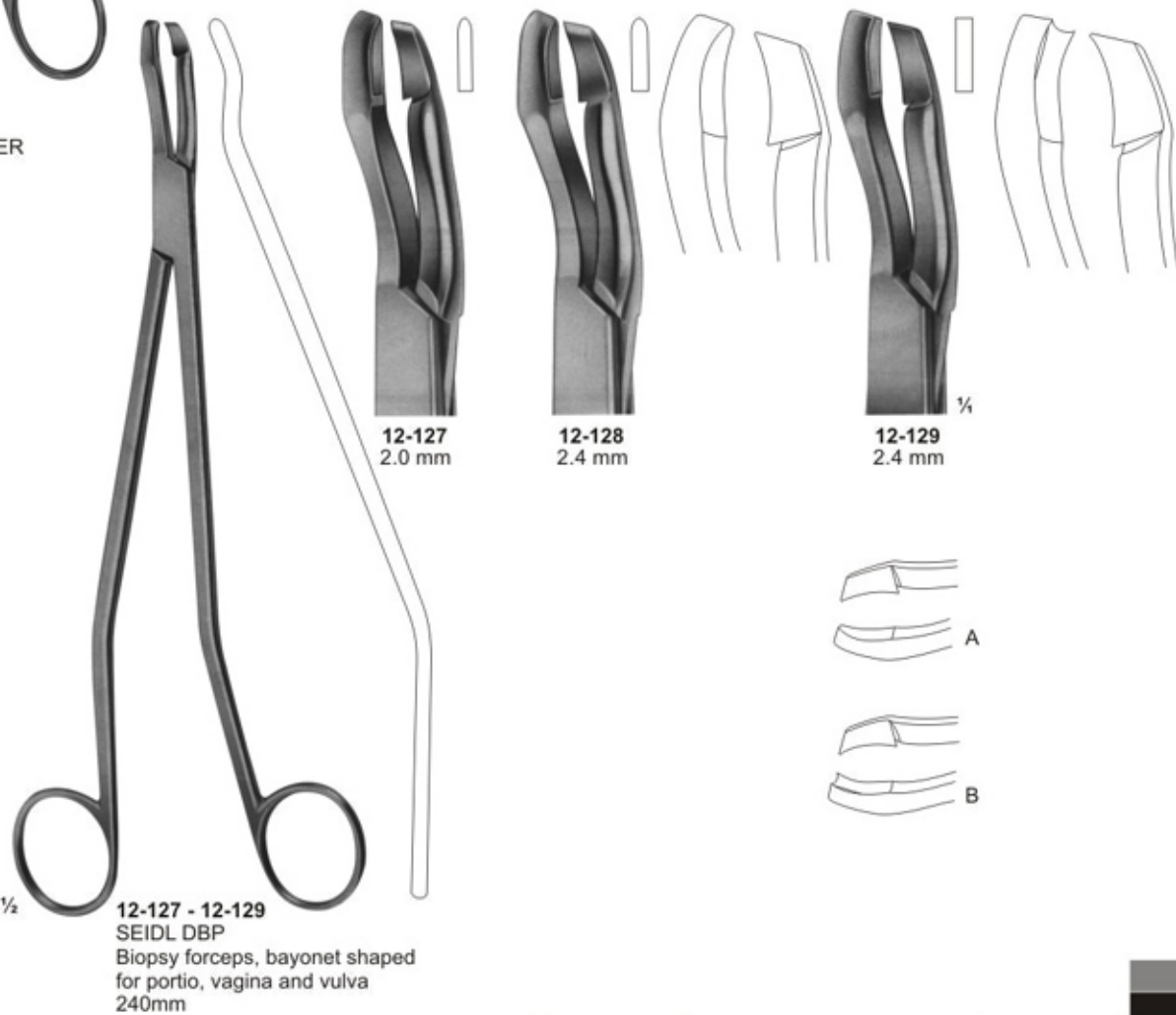
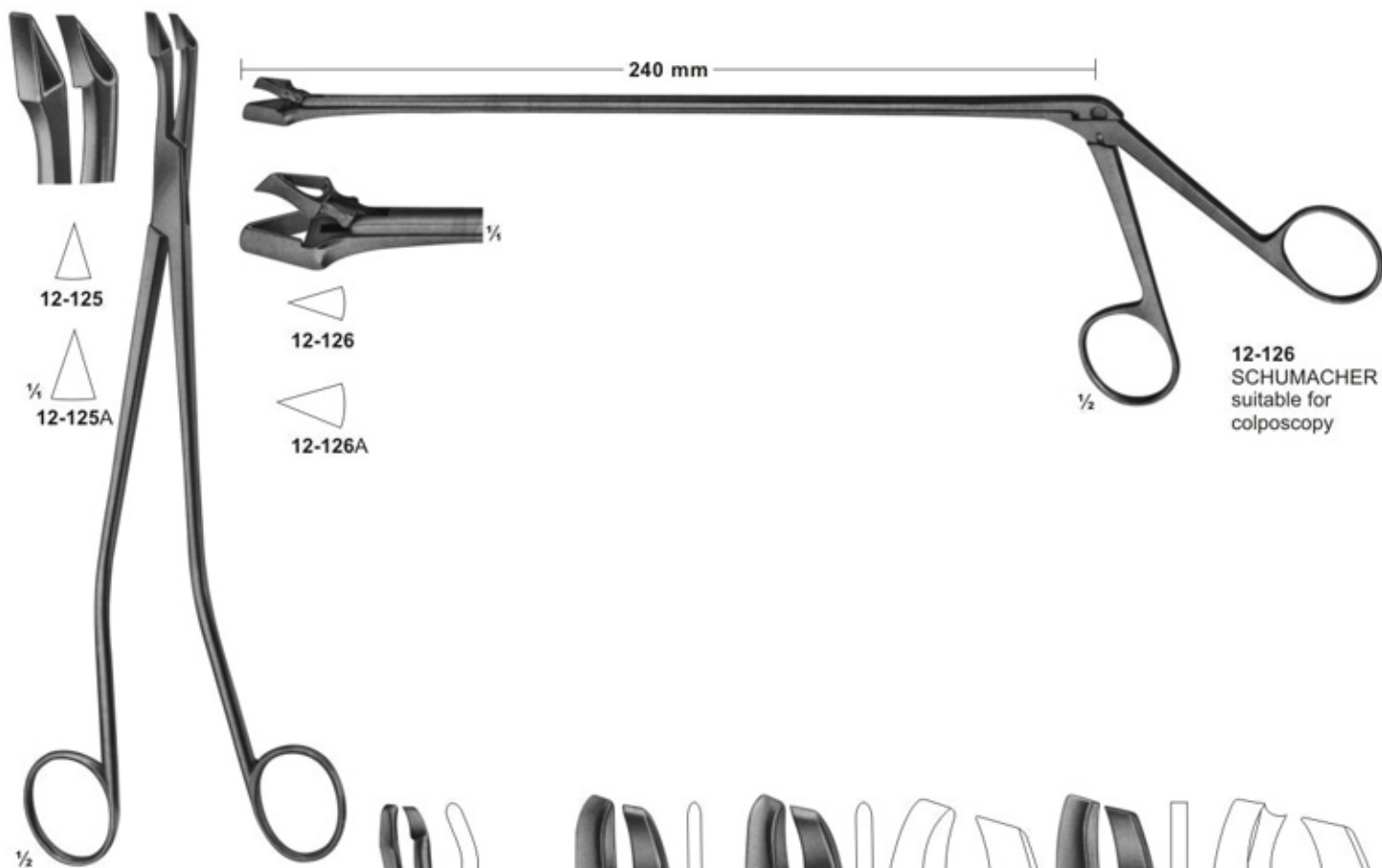

Biopsy Forceps

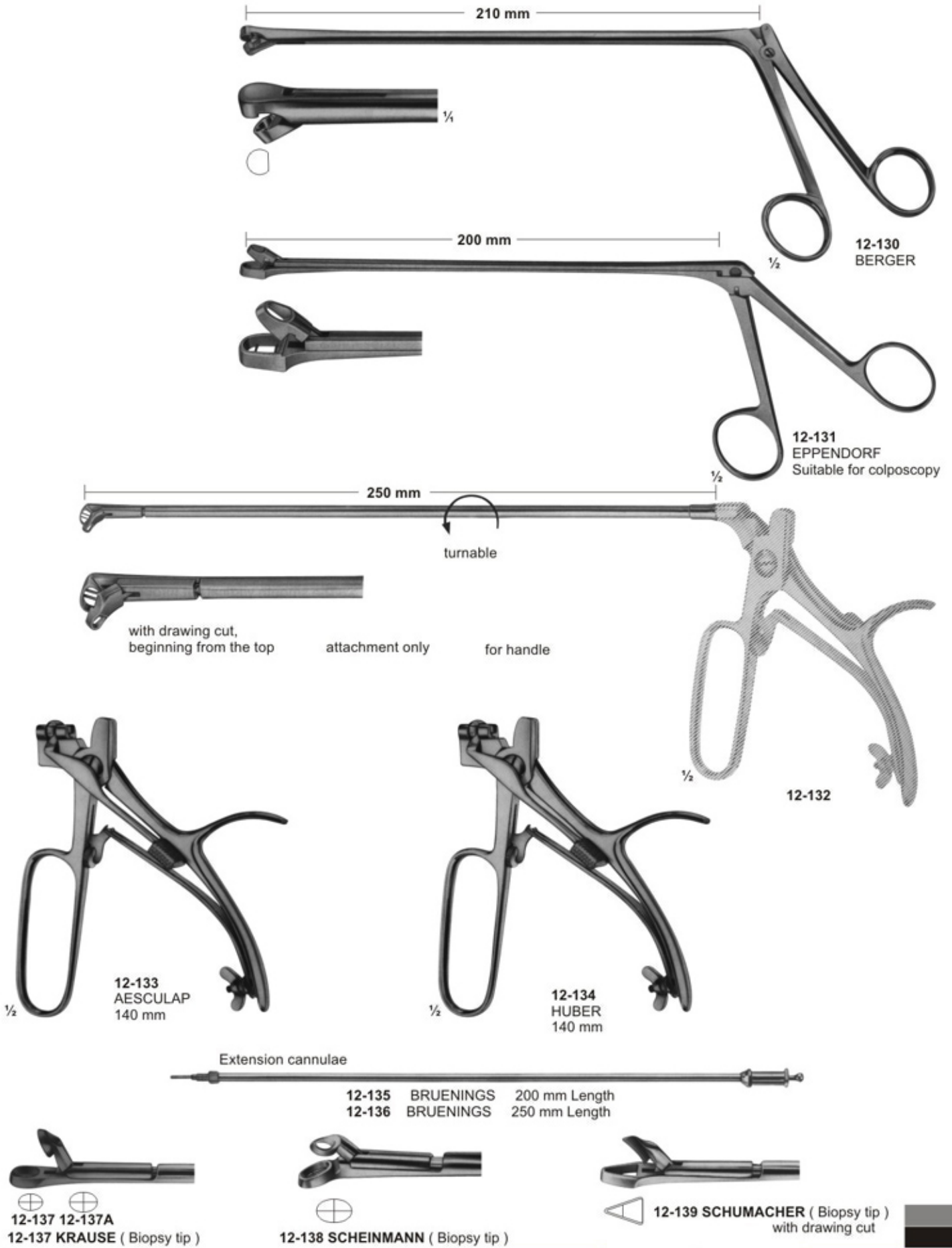

Uterine Scoops



12-140
SIMON
240 mm

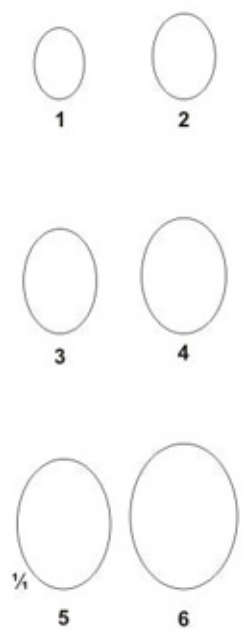

12-141
SCHROEDER
310 mm

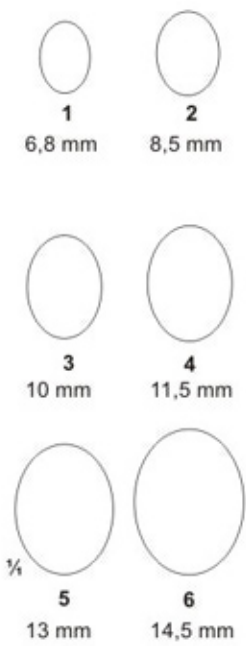

12-142
RECAMIER
300 mm

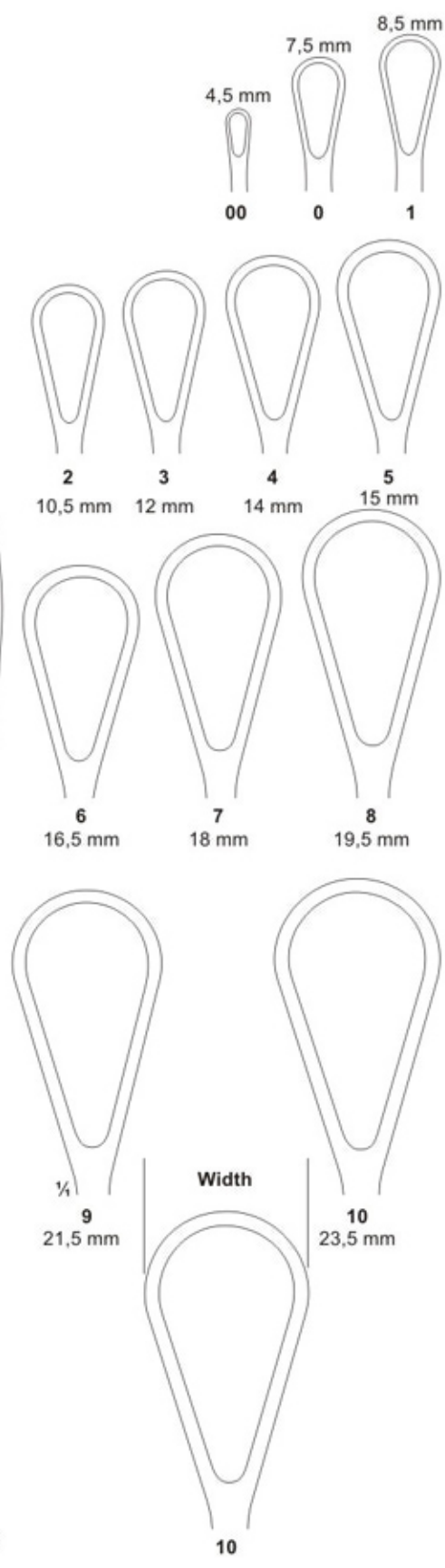

Obstetrical Forceps



1/3

13-101
NAEGELE
355 mm



1/3

13-102
NAEGELE
400 mm



1/3

13-103
SIMPSON-BRAUN
305mm

Obstetrics- Placenta and Ovum Forceps

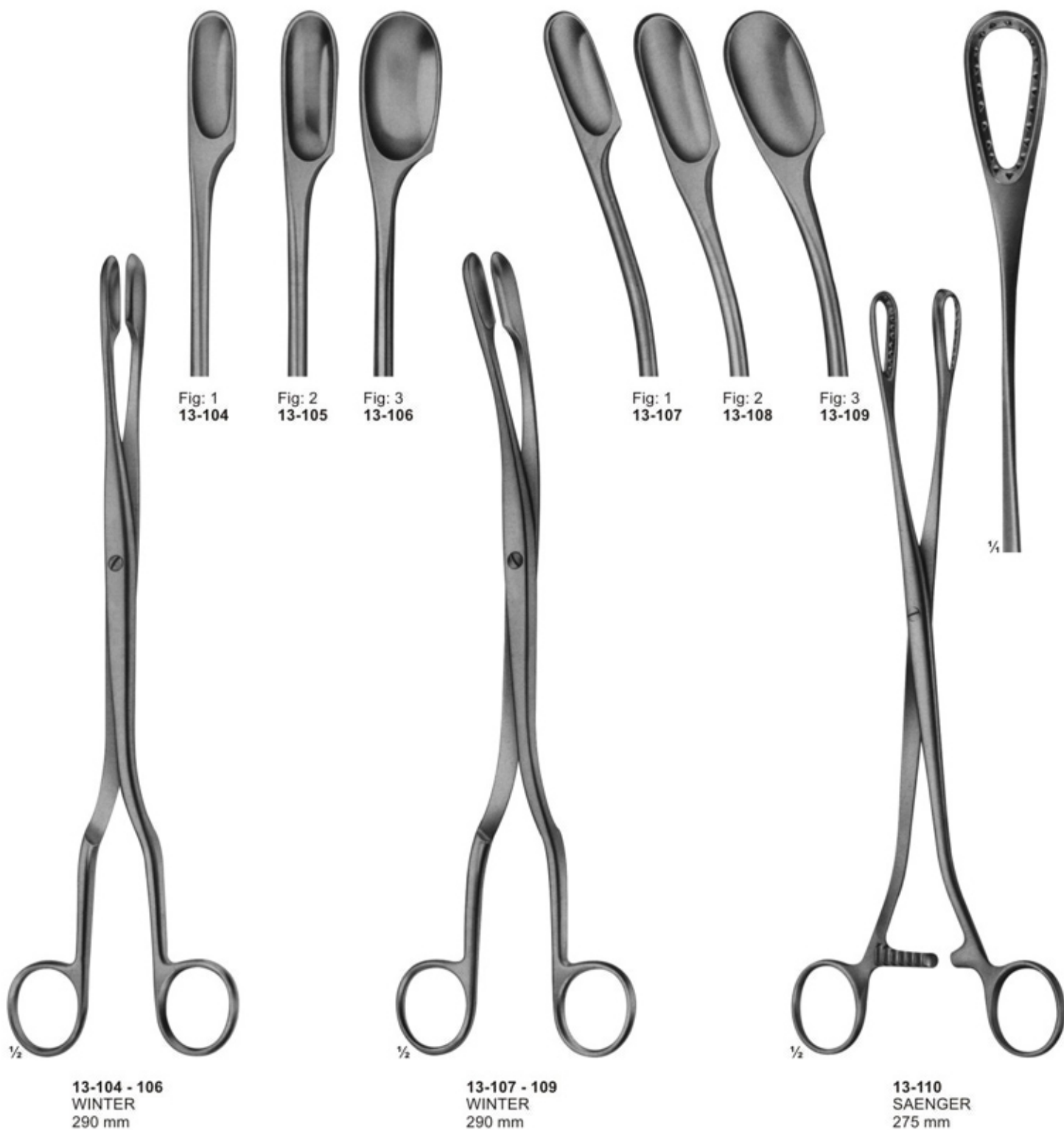

Tound-and Tracheal Hooks and Dilators

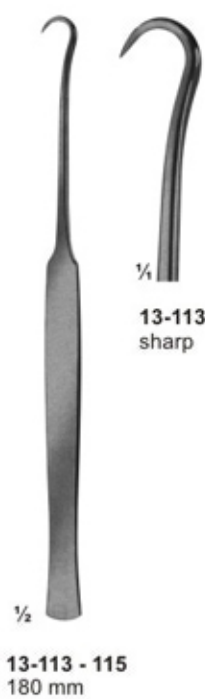
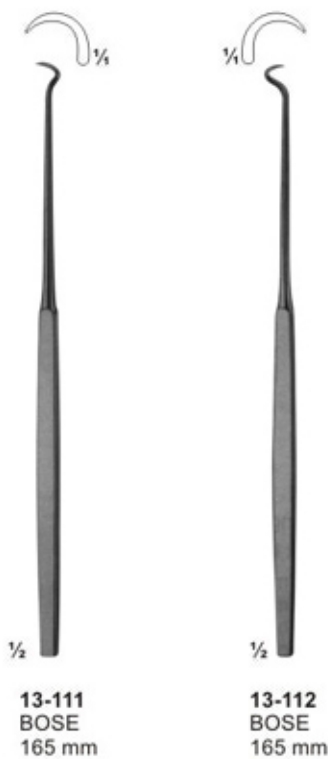

Vascular Spatulas

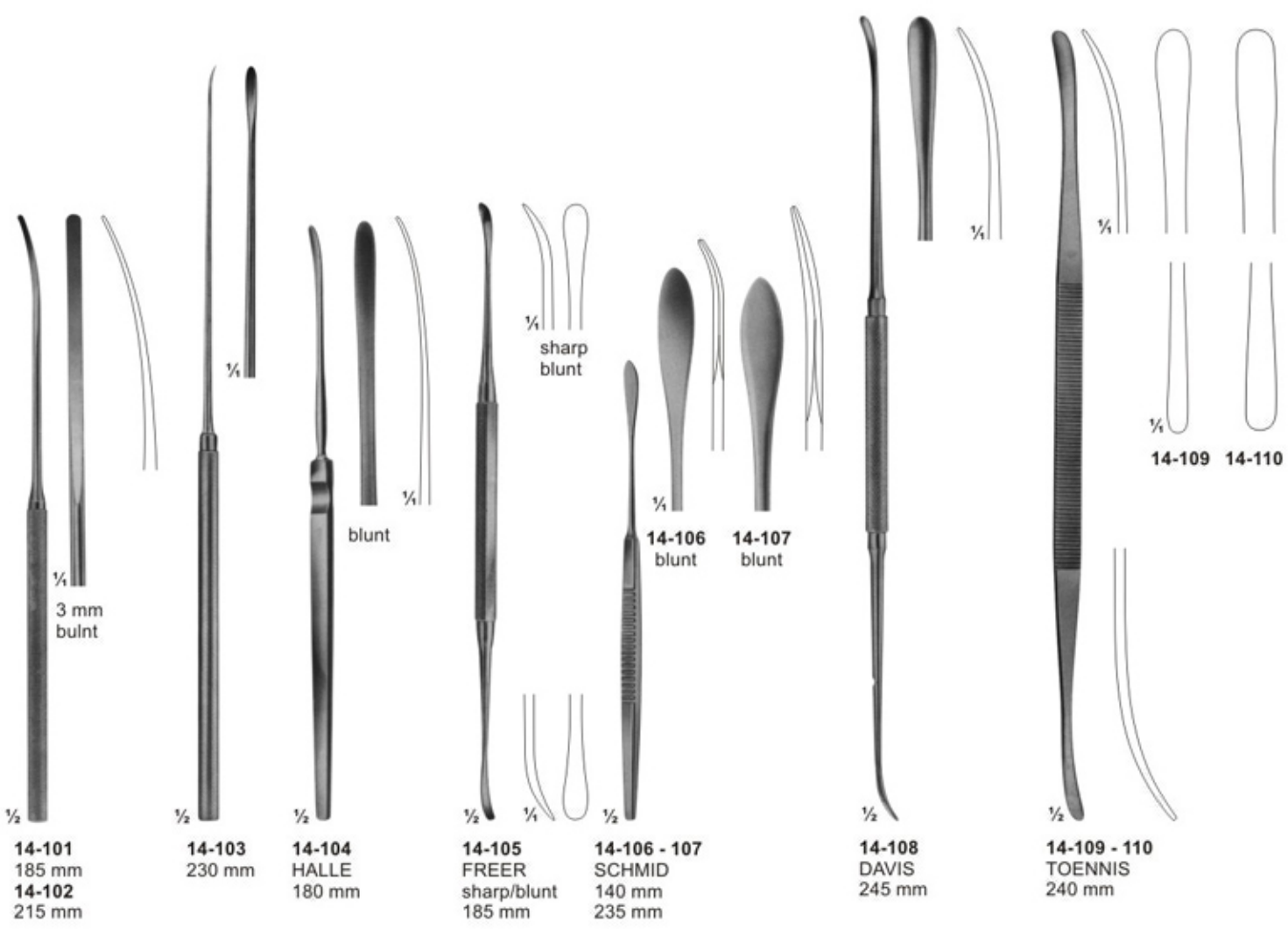

ATRAUMATA Forceps

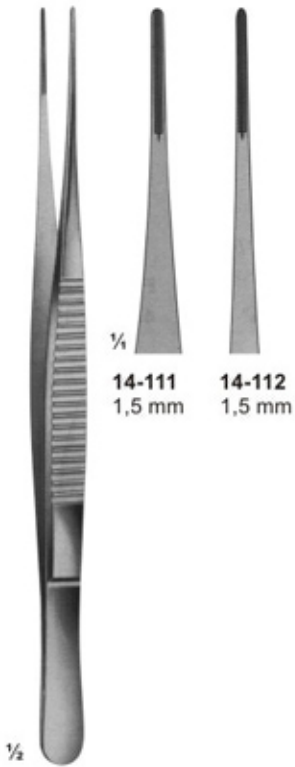

1/4
14-111
 1,5 mm
14-112
 1,5 mm

1/2
14-111 - 112
 DE BAKEY
 150 mm
 200 mm

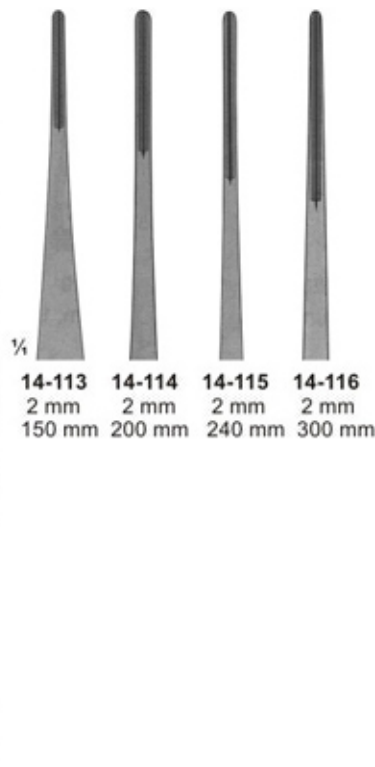

1/4
14-113
 2 mm
 150 mm
14-114
 2 mm
 200 mm
14-115
 2 mm
 240 mm
14-116
 2 mm
 300 mm

1/2
14-113 - 116
 DE BAKEY

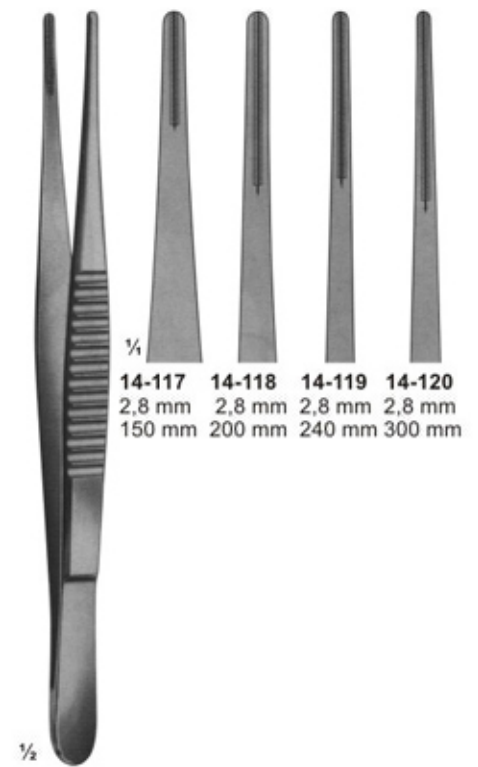

1/4
14-117
 2,8 mm
 150 mm
14-118
 2,8 mm
 200 mm
14-119
 2,8 mm
 240 mm
14-120
 2,8 mm
 300 mm

1/2
14-117 - 120
 DE BAKEY

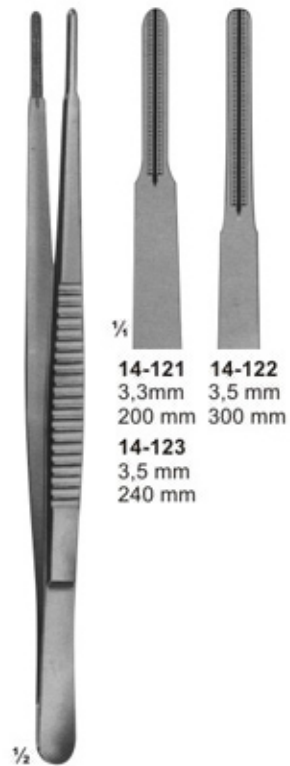

1/4
14-121
 3,3mm
 200 mm
14-122
 3,5 mm
 300 mm
14-123
 3,5 mm
 240 mm

1/2
14-121 - 123
 DE BAKEY

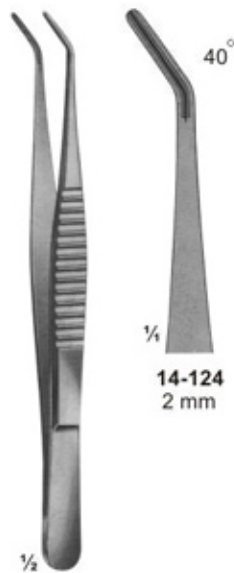

40°
 1/4
14-124
 2 mm

1/2
14-124
 DE BAKEY
 150 mm

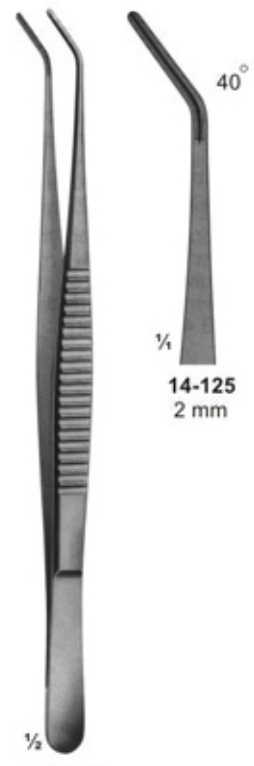

40°
 1/4
14-125
 2 mm

1/2
14-125
 DE BAKEY
 200 mm

ATRAUMATA

Anastomosis- and Multi- Purpose- Clamps- Pediatric types

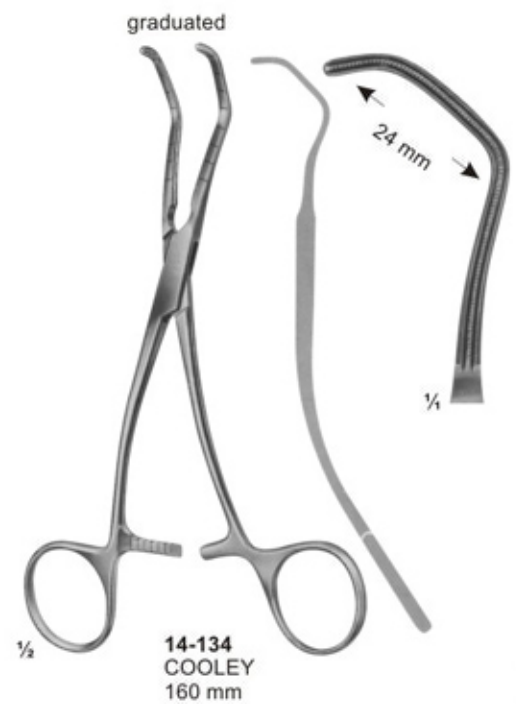
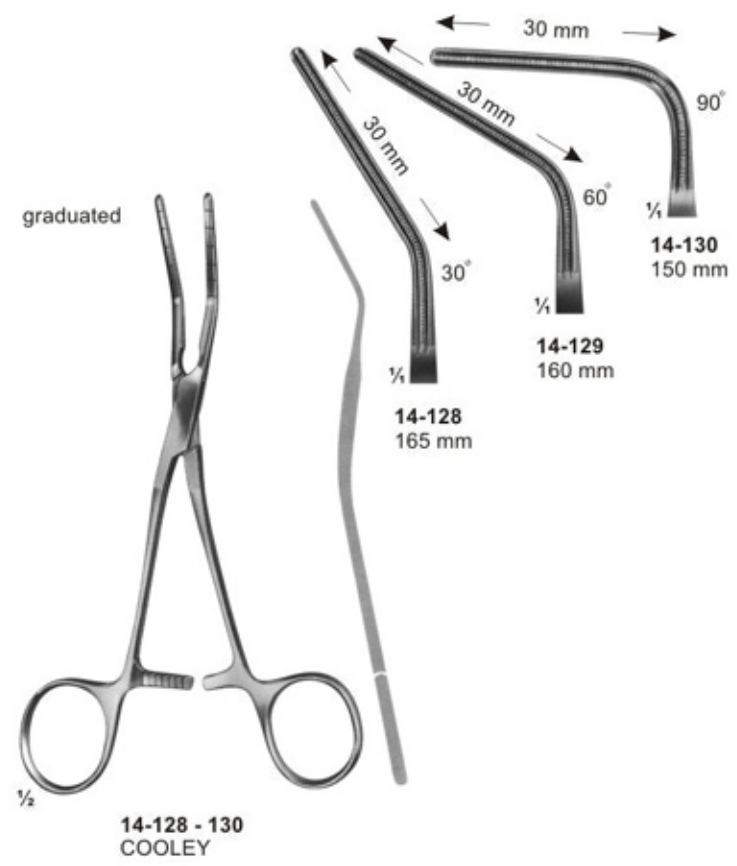
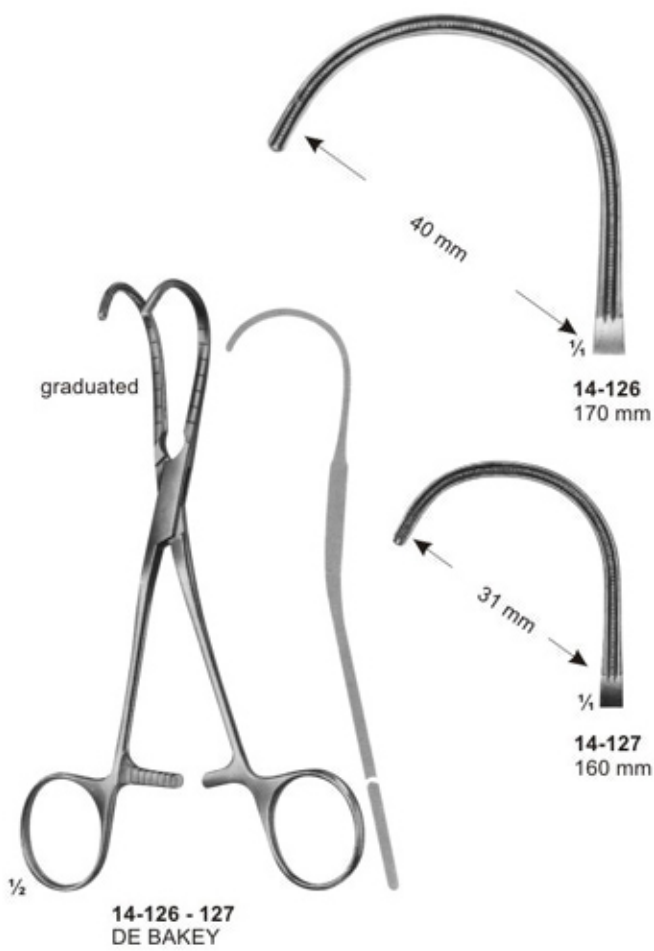

ATRAUMATA

Coarctation Clamps, Patent-Ductus & Peripheral-Vascular Clamps

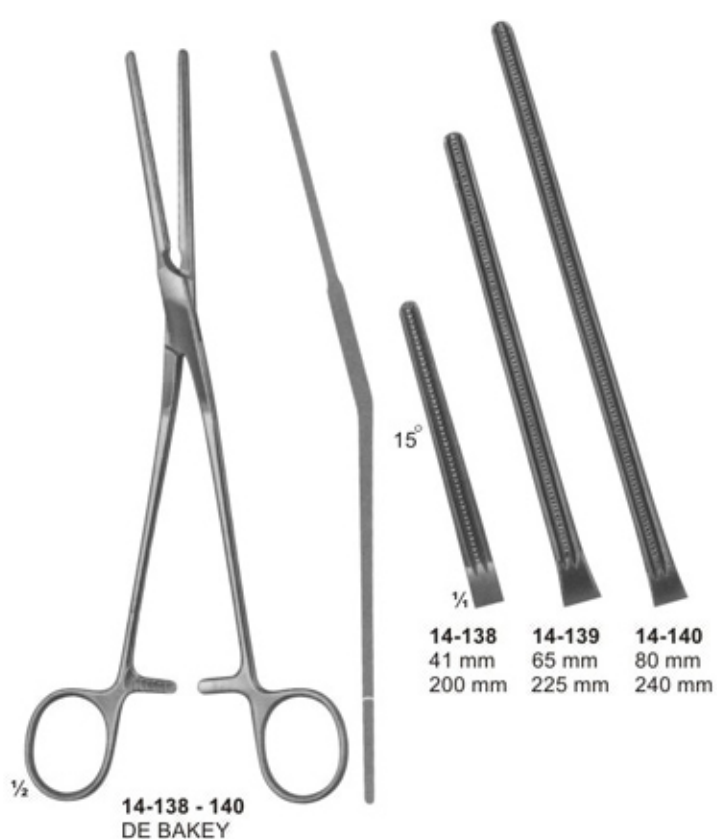
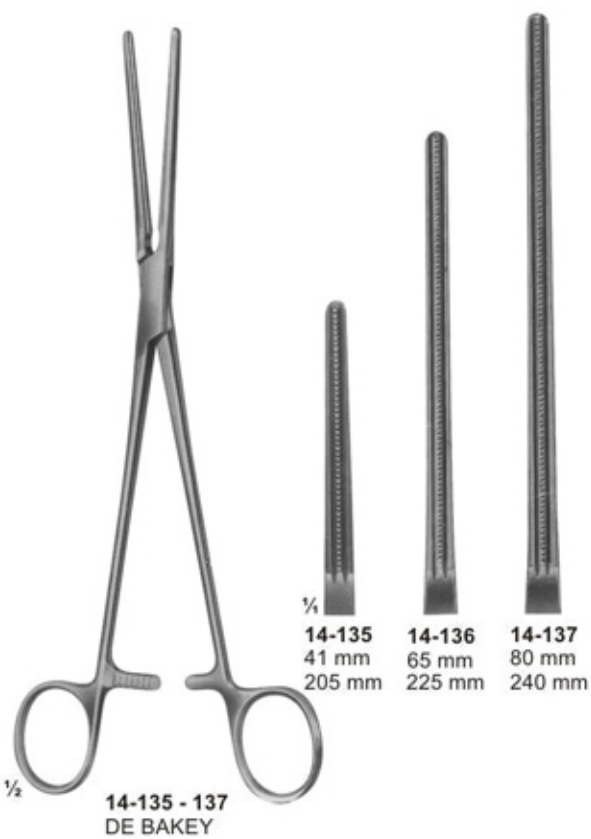

Aorta- Anastomosis Clamps



L
14-144
WEBER
260 mm

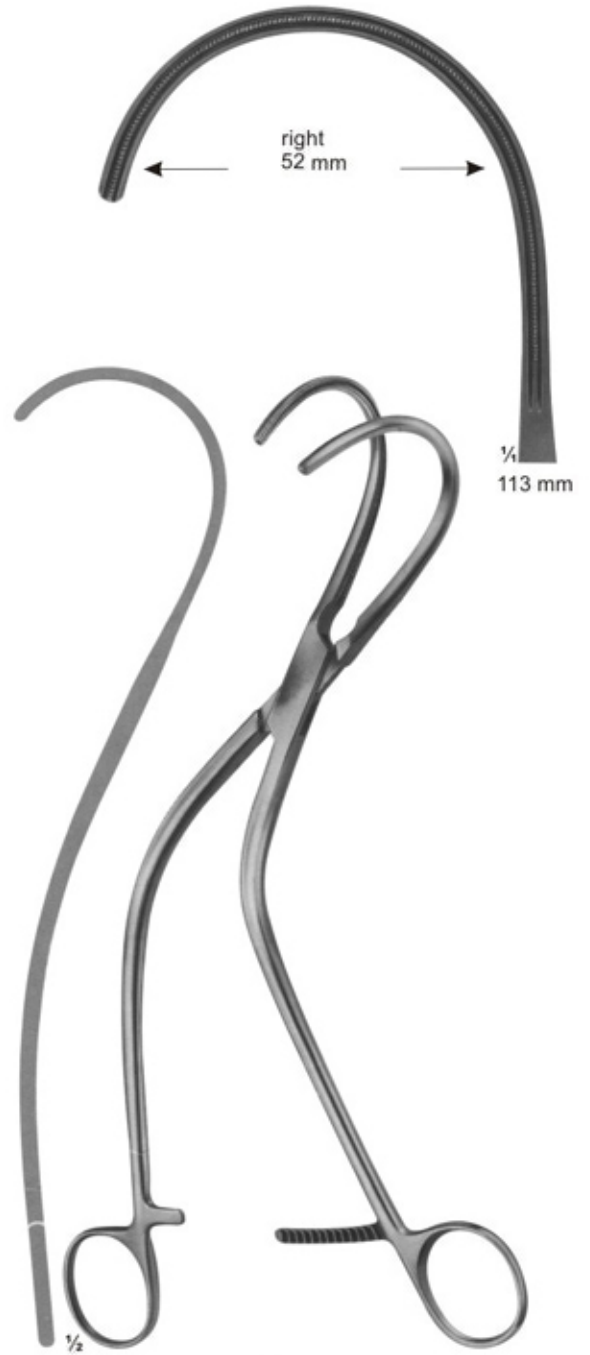

R
14-145
WEBER
260 mm

Multi- Purpose-Clamps



1/2 **14-146 - 149**
DE BAKEY

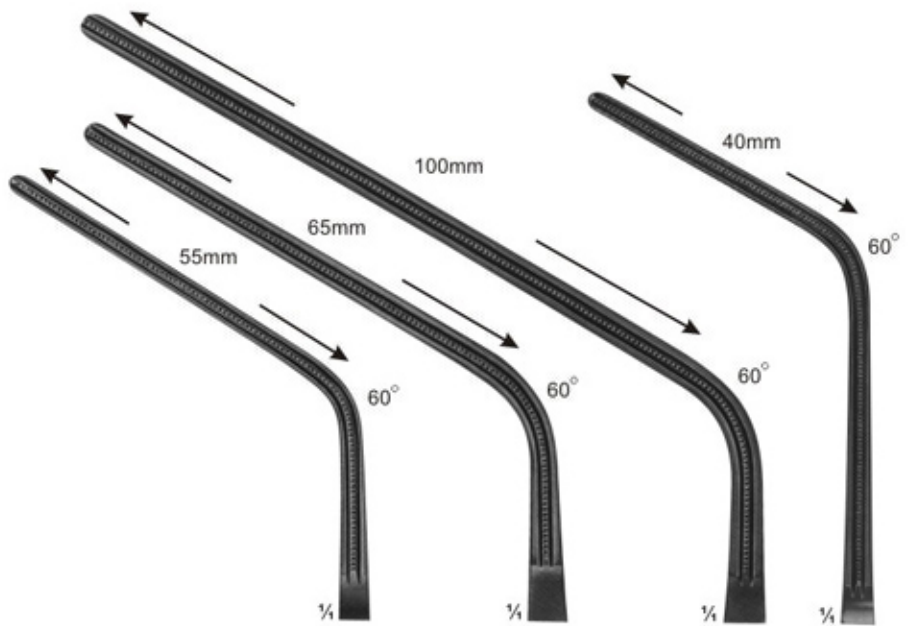

14-146 **14-147** **14-148** **14-149**

Total Length:	230 mm	280 mm	305 mm	240 mm
Length of jaws:	85 mm	100 mm	135 mm	93 mm



1/2 **14-150 - 153**
DE BAKEY

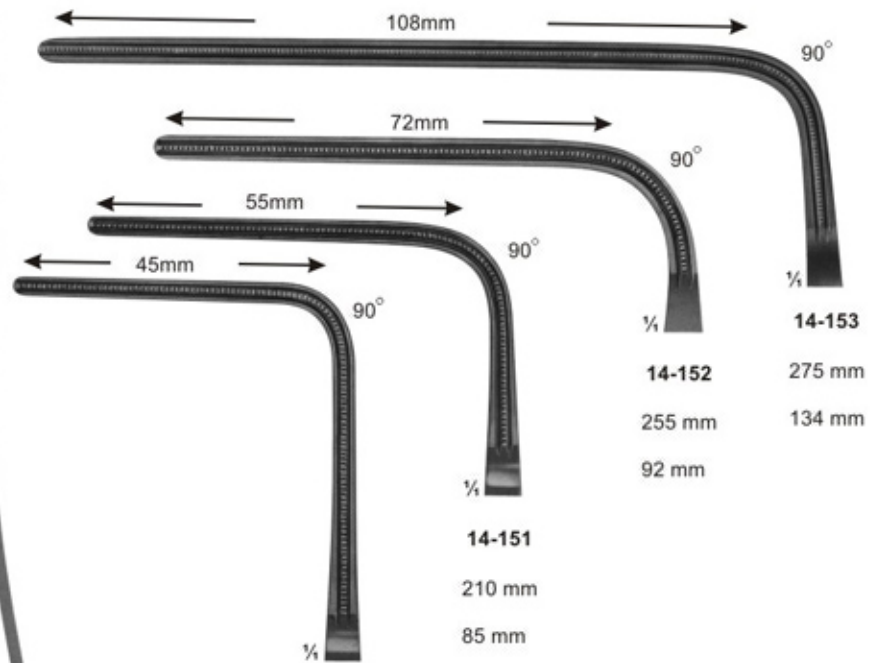

14-150 **14-151** **14-152** **14-153**

Total Length:	225 mm	210 mm	275 mm	255 mm
Length of jaws:	93 mm	85 mm	134 mm	92 mm

Sternum Instruments and Rib Shears



14-154
SCHUMACHER
Sternum shears
210 mm



14-155
LEBSCHKE
Sternum chisel
200 mm



14-156
230 mm



14-157
COLLIN
195 mm



14-158
GLUCK
190 mm



14-159
BETHUNE
340 mm



14-160
BRUNNER
Universal pattern
340 mm



14-161
GIERTZ-STILLE
250 mm

Rib Spreaders



14-162
FINOCHIETTO
Blades
18X21 mm

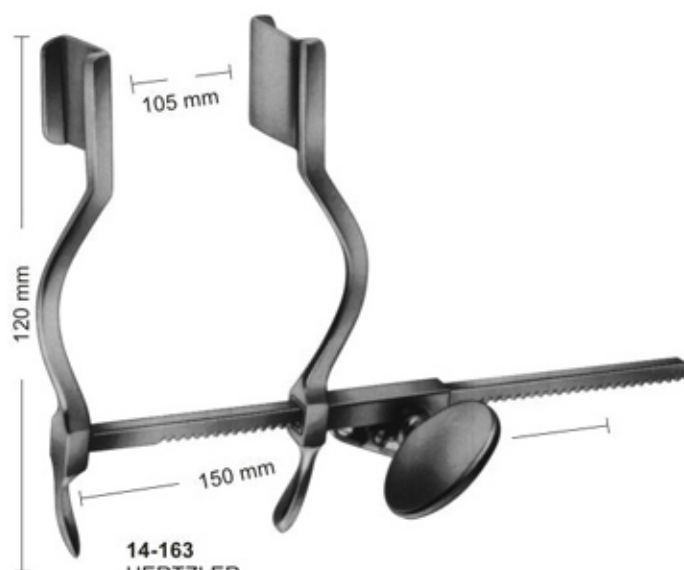

14-163
HERTZLER
Blades
20X25 mm

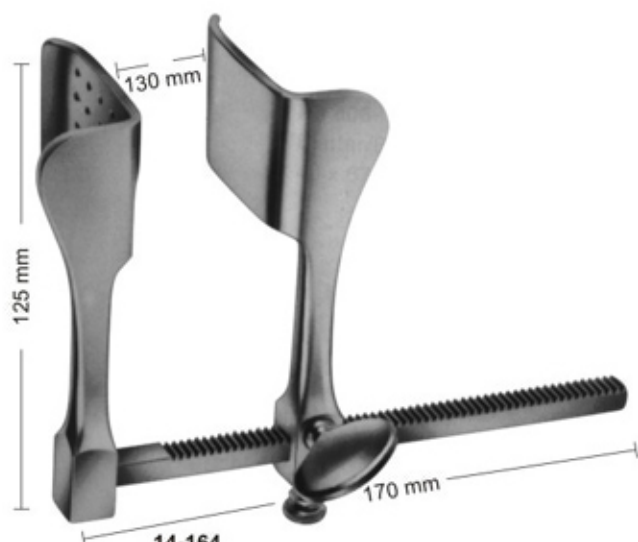

14-164
TUFFIER
Blades
43X53 mm

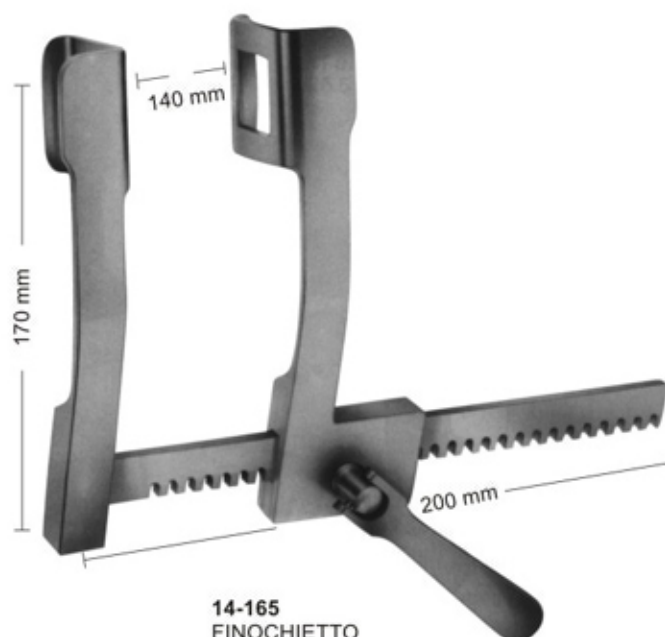

14-165
FINOCHIETTO
Blades
36X45 mm

Rib Spreaders-and Contractors



14-166
SELLORS
Rib spreader-and contractor
with swivel blades
200 mm



14-167
BAILEY
150 mm



14-168
for children

14-169
for adults

14-168 - 169
BAILEY
200 mm

Punches

130° upwards cutting

15-101
1 mm 

KERRISON - JACOBY

FERRIS-SMITH-KERRISON

15-102
2 mm 

15-103
3 mm 

15-104
4 mm 

15-105
5 mm 

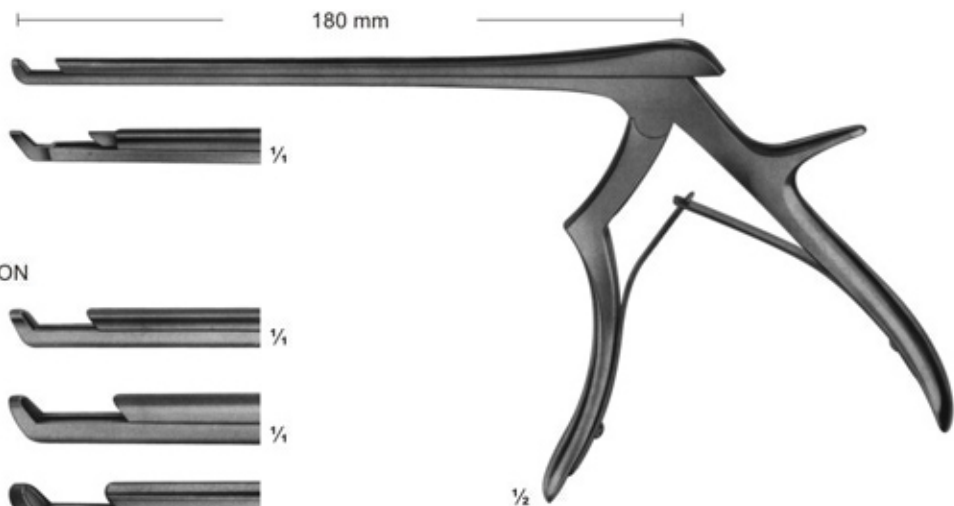

15-101 - 105

90° upwards cutting

KERRISON - JACOBY

15-106
1 mm 

15-107
2 mm 

FERRIS-SMITH-KERRISON

15-108
3 mm 

15-109
4 mm 

15-110
5 mm 

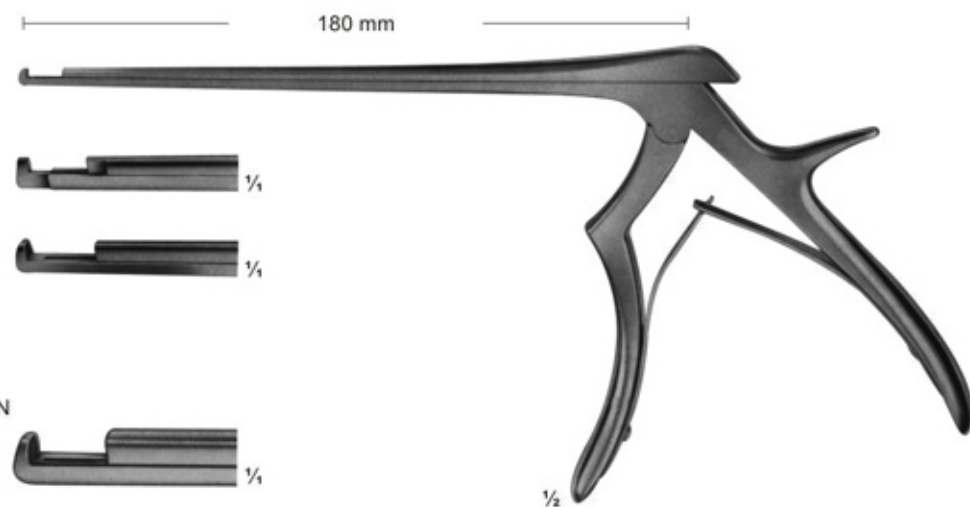

15-106 - 110

Punches

90° upwards cutting

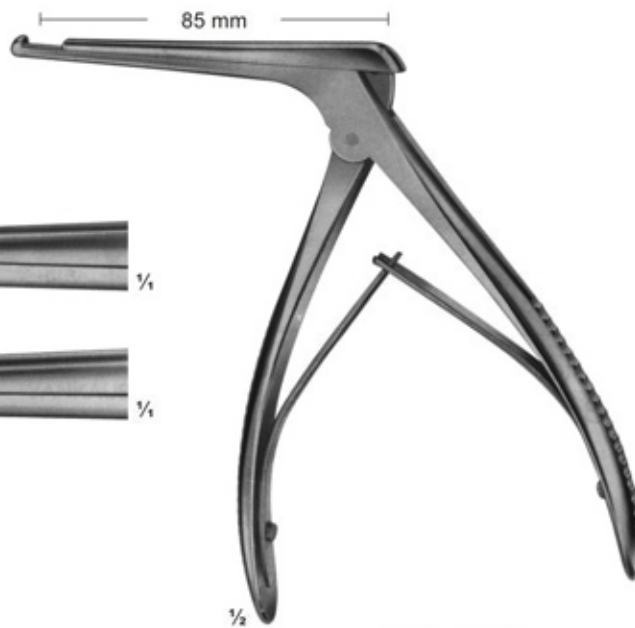

15-111
4 mm



15-112
5 mm



15-111 - 15-112
KERRISON

90° upwards cutting

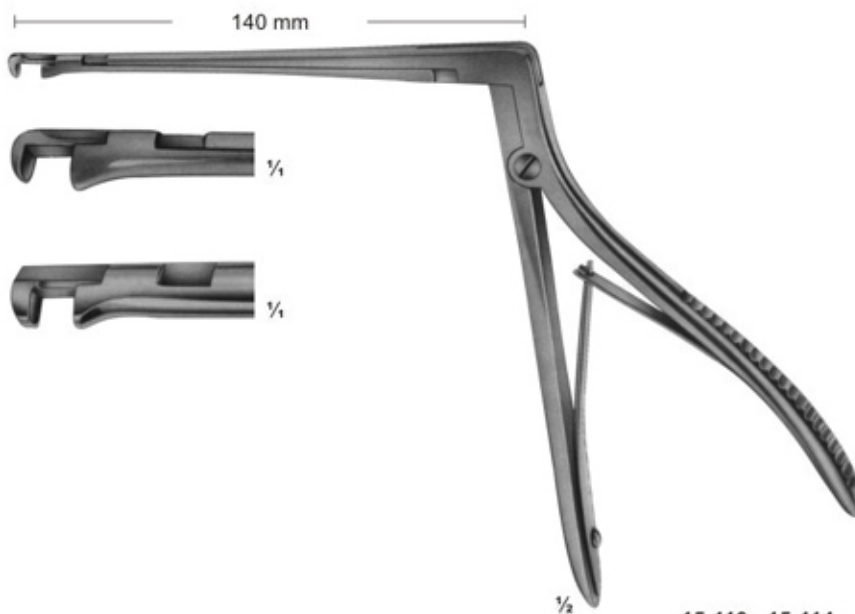

15-113
3,3 mm



15-114
4,0 mm



15-113 - 15-114
HAJEK-KOFLER

Rongeurs

LOVE-GRUENWALD

15-115
2 X 10 mm

15-116
3 X 10 mm

SPURLING
15-117
4 X 10 mm

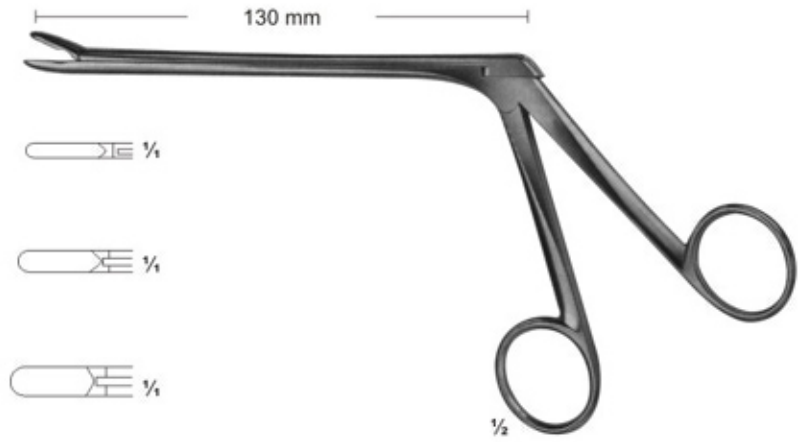

15-115 - 15-117

15-118
2 mm

15-119
3 mm

15-120
4 mm

15-121
5 mm

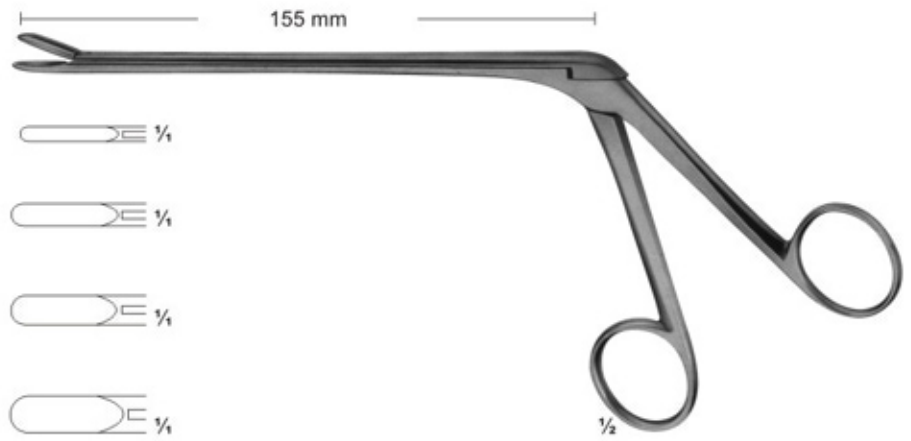

15-118 - 15-121
CASPAR

150°

15-122
2 mm

15-123
3 mm

15-124
4 mm

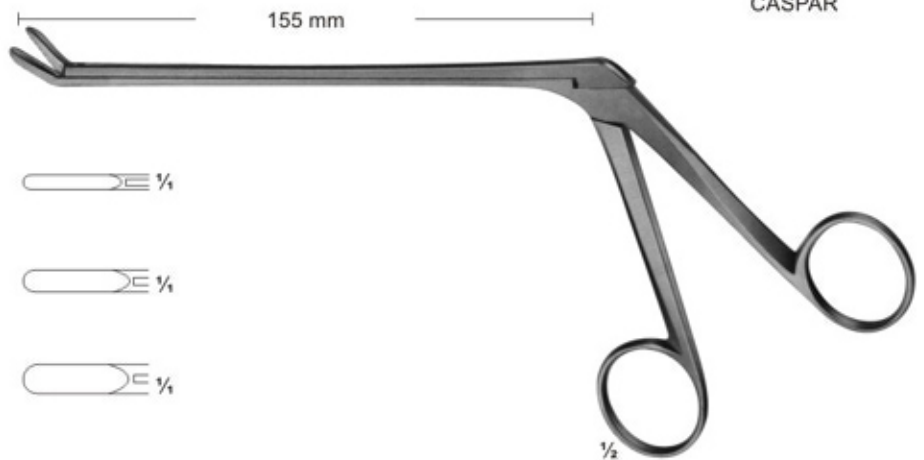

15-122 - 15-124
CASPAR

Rongeurs

Angled positions for rongeurs

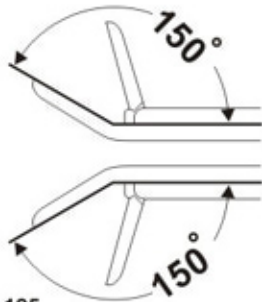

15-125
3,0 mm

15-126
3,6 mm

15-127
4,2 mm

15-128
4,8 mm

15-129
5,8 mm

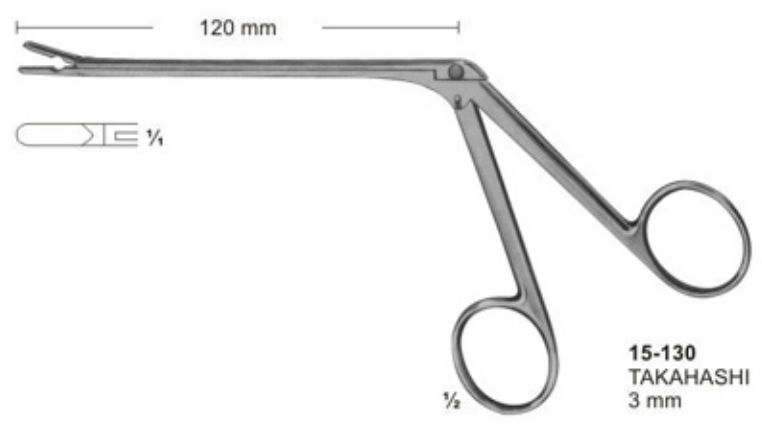
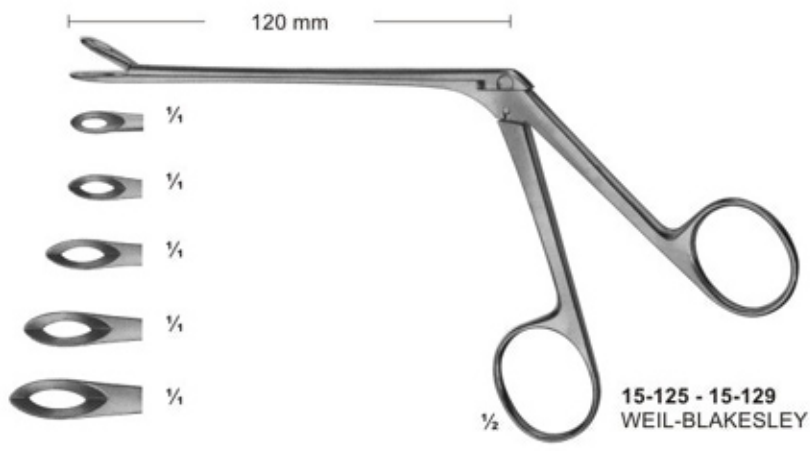
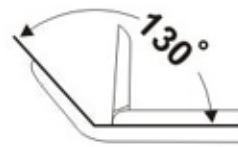
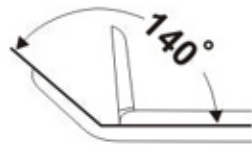

130°

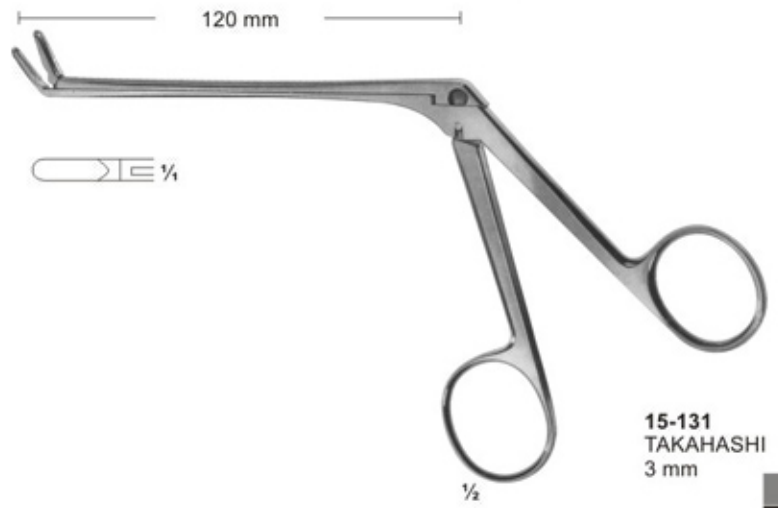

Rongeurs

150°

Lower part of jaws movable

15-132
2 mm

15-133
3 mm

15-134
4 mm

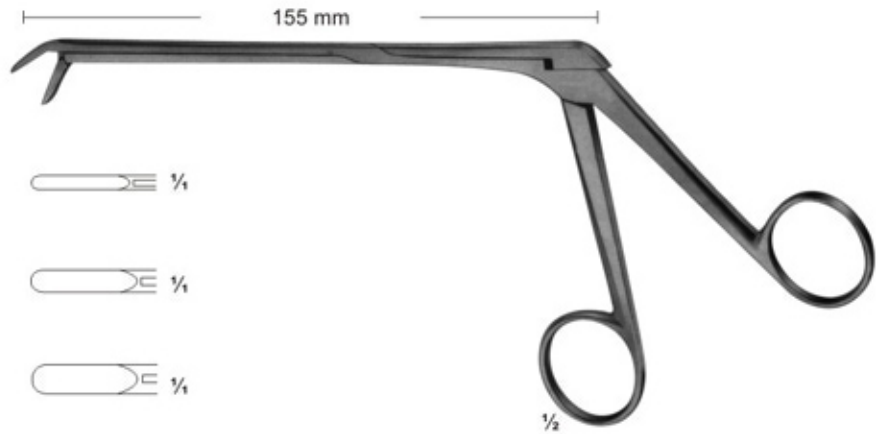

15-132 - 15-134
CASPAR

Length of shaft 140 mm	Length of shaft 160 mm	Length of shaft 185 mm	size of jaws
15-135	15-140	15-145	2 X12 mm
15-136	15-141	15-146	3 X12 mm
15-137	15-142	15-147	4 X14 mm
15-138	15-143	15-148	5 X14 mm
15-139	15-144	15-149	6 X16 mm

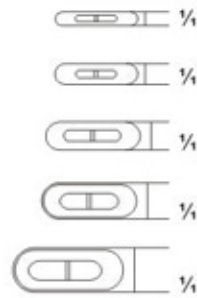

15-135 - 15-149
CASPAR

150°

Length of shaft 140 mm	Length of shaft 160 mm	Length of shaft 185 mm	size of jaws
15-150	15-153	15-156	3 X12 mm
15-151	15-154	15-157	4 X14 mm
15-152	15-155	15-158	5 X14 mm

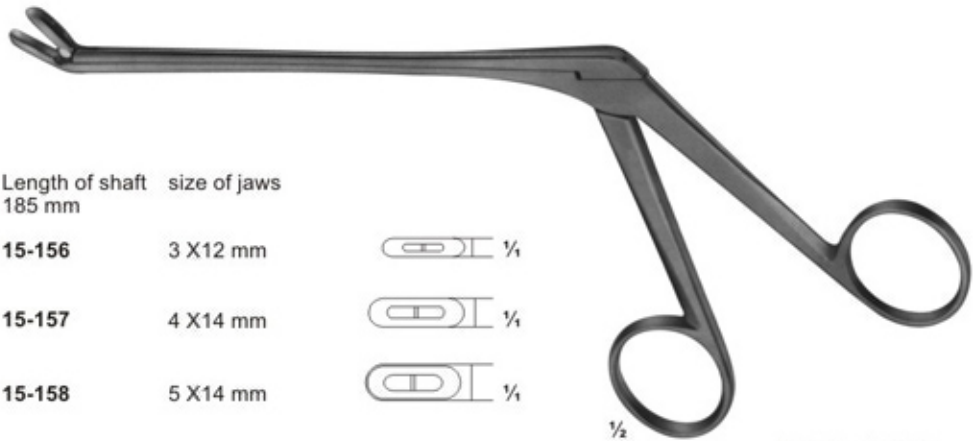

15-150 - 15-158
CASPAR

Rongeurs

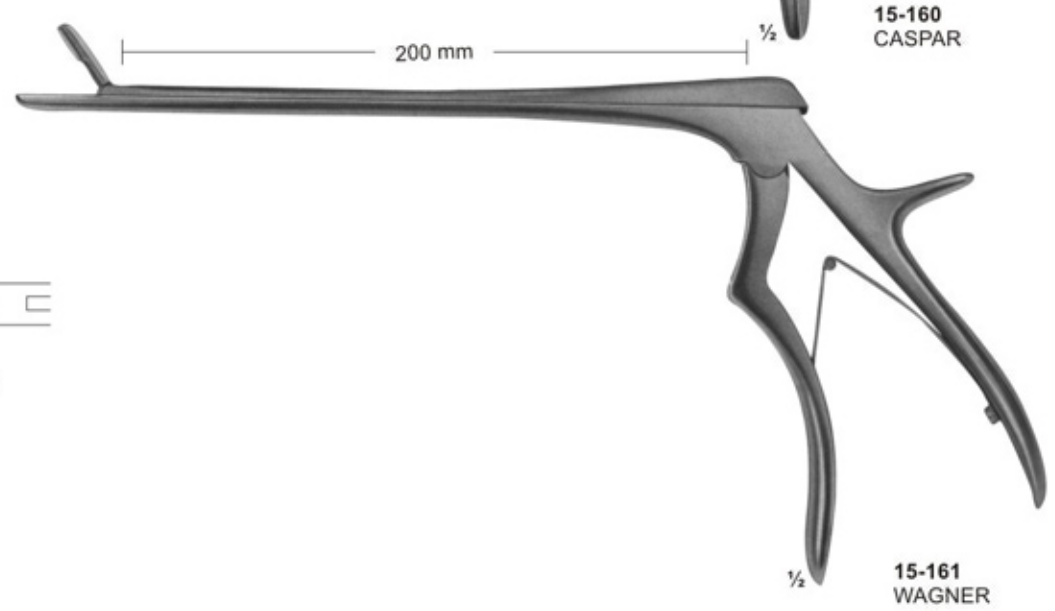
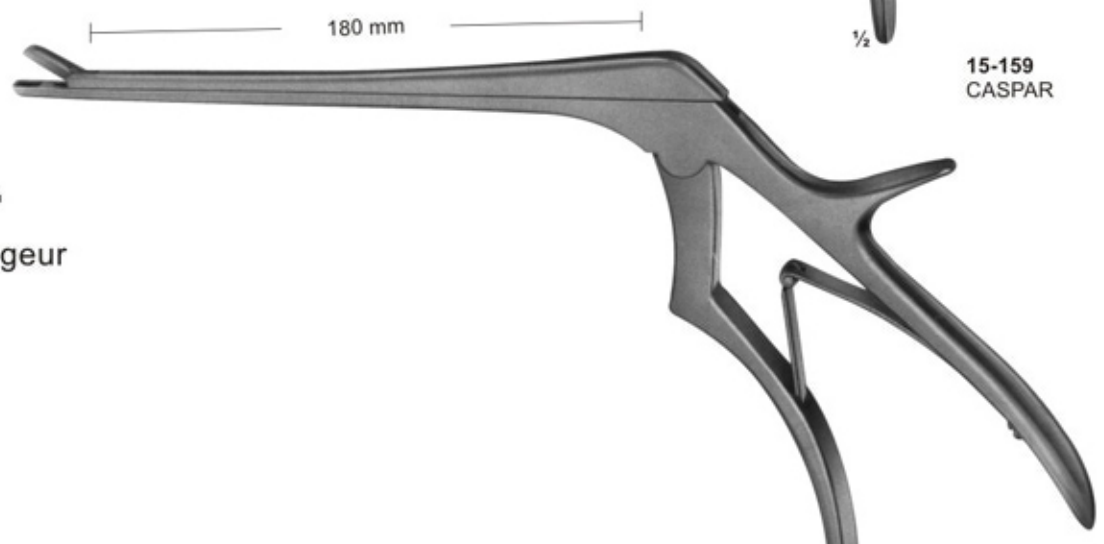
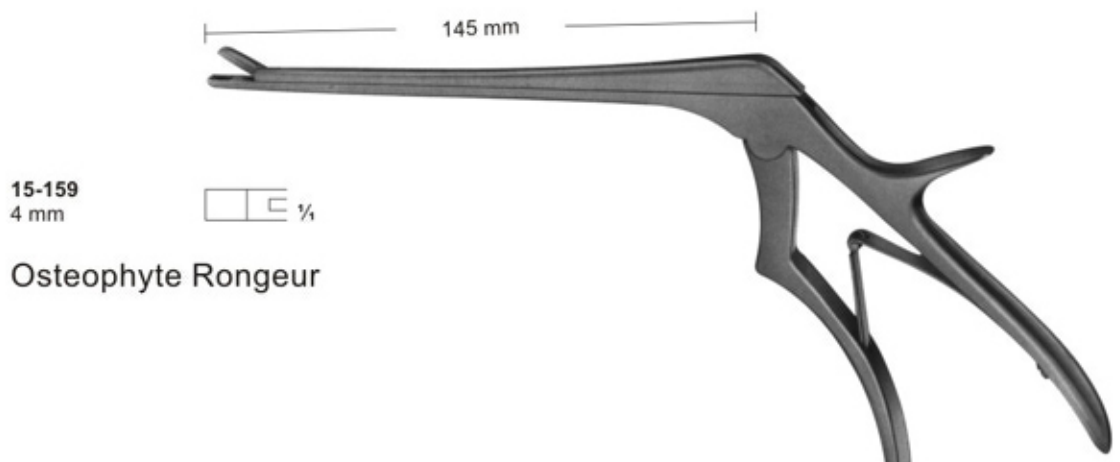

Elevators and Bone Levers

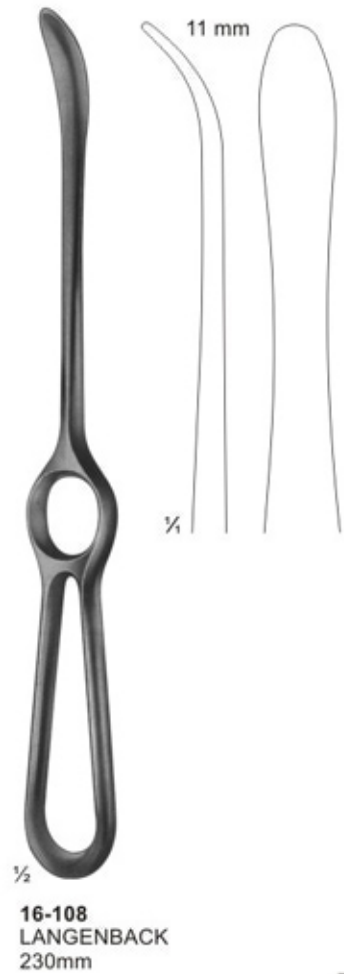
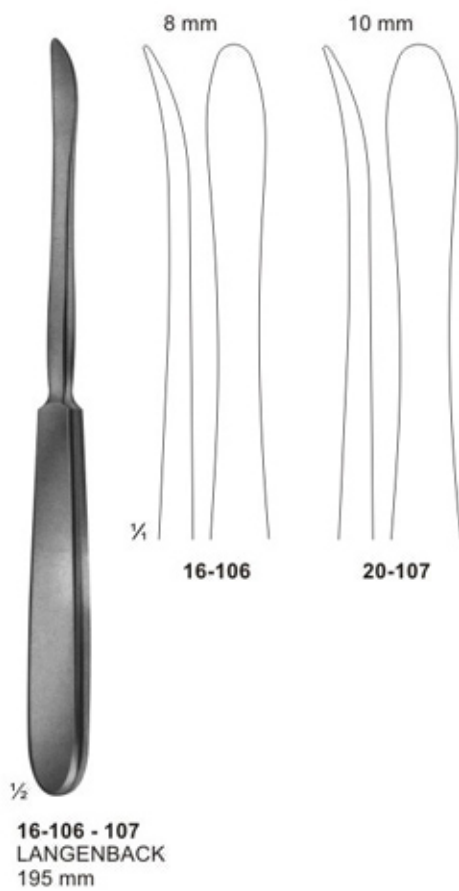
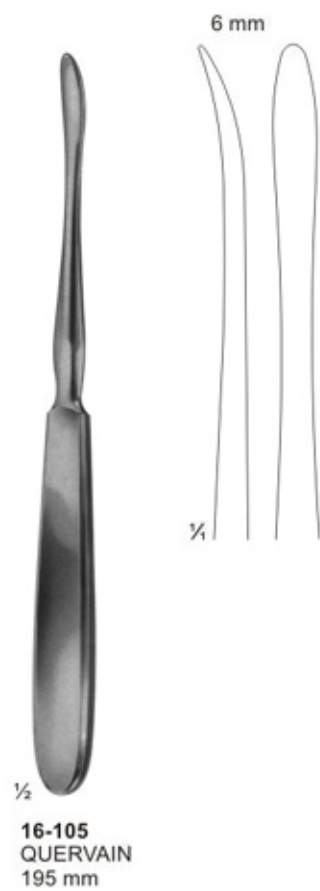
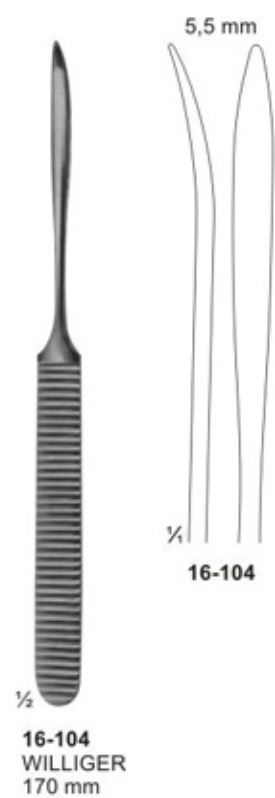
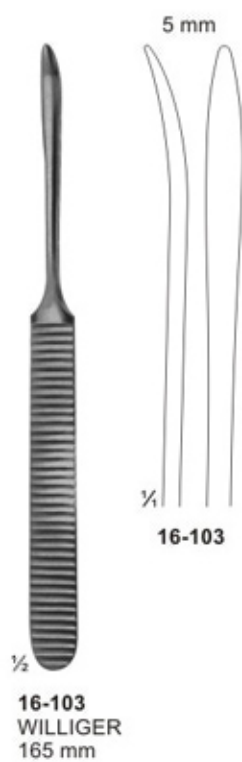
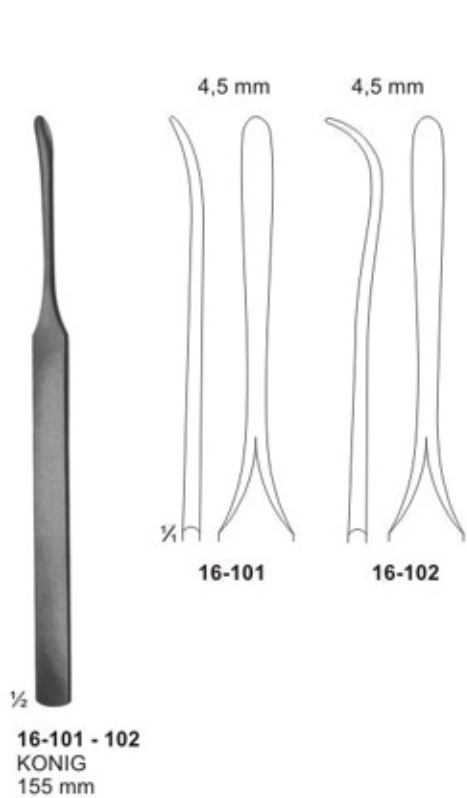

Bone Levers



1/2
16-109
 LANE TRETHOWAN
 215mm

1/2
16-110
 LANE
 255mm

1/2
16-111
 LANGE-HOHMANN
 250mm

1/2
16-112 - 113
 LANGE-HOHMANN modif.
16-112 265mm
16-113 280mm

16-112
 30 mm
 16-113
 33 mm

Raspatories



16-114
 PARTSCH
 150 mm

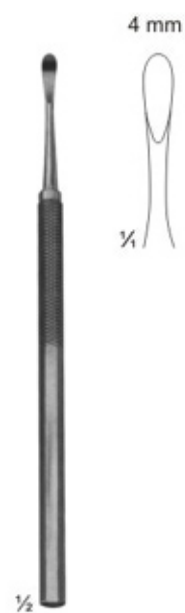

16-116
 PARTSCH mod. LANGE
 145 mm



16-117
 MC KENTY
 155 mm

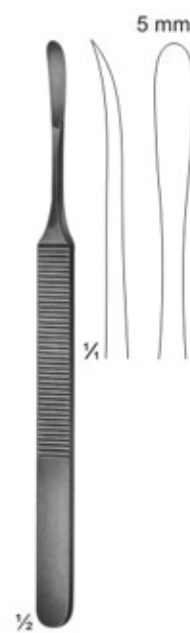

16-118
 KOENIG
 155 mm

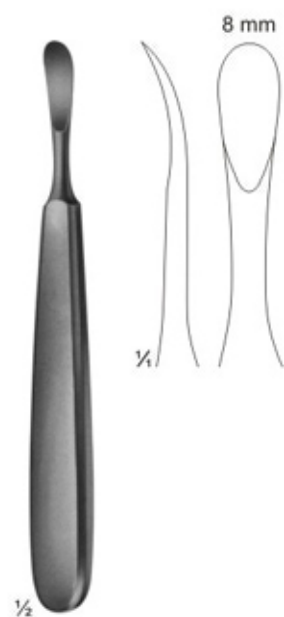

16-119
 TRELAT
 150 mm

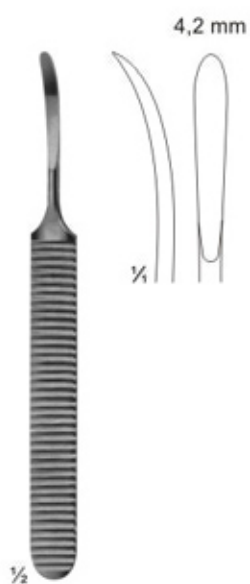

16-120
 WILLIGER
 140 mm



16-121
 WILLIGER
 160 mm

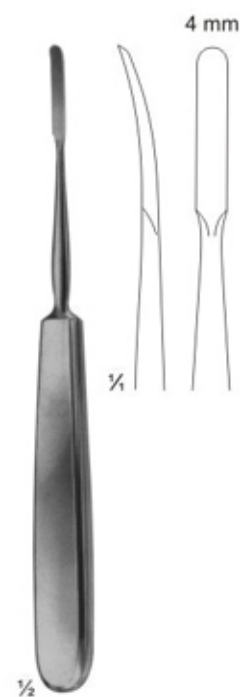

16-122
 JOSEPH
 170 mm

Bone File and Rasps

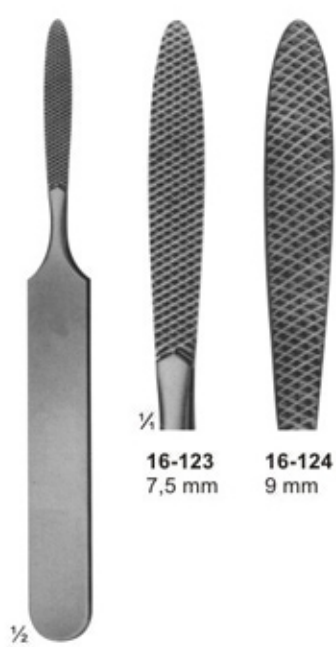

16-123
7,5 mm

16-124
9 mm

16-123
JOSEPH
fine, chequered

16-124
coarse, chequered
165 mm

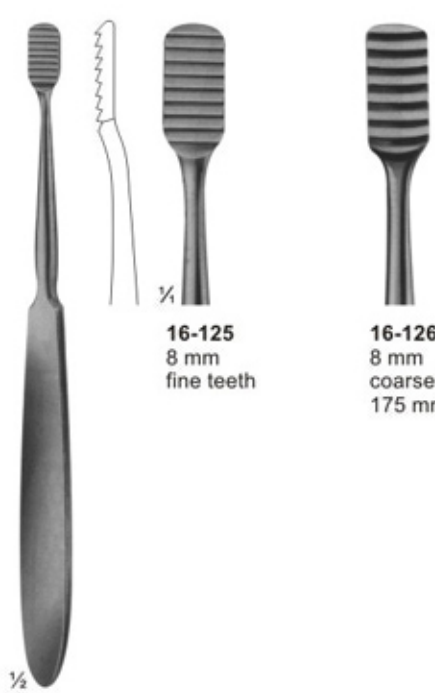

16-125
8 mm
fine teeth

16-126
8 mm
coarse teeth
175 mm

16-125 - 16-126
LEWIS



16-127
9 mm

16-127
MALTZ
down stroke
180 mm

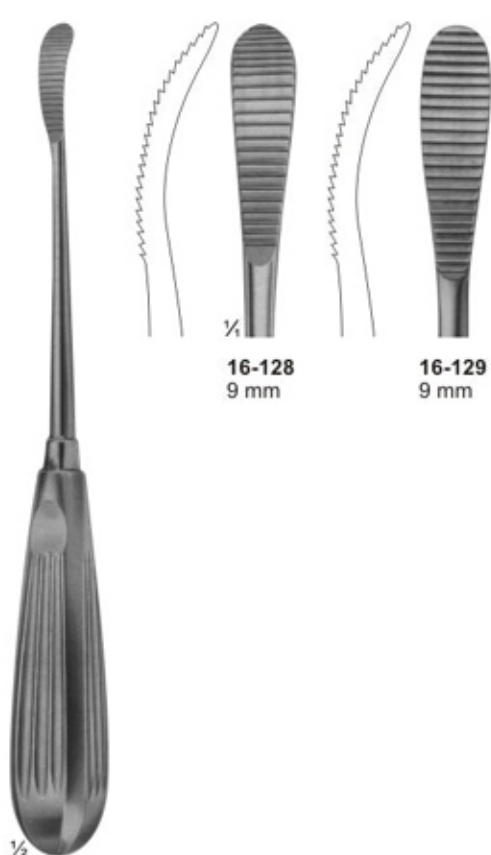

16-128
9 mm

16-129
9 mm

16-128 - 16-129
AUFRICHT
up stroke
16-129
down stroke
220 mm



16-130
6,5 mm

16-130
GALLAHER
190 mm

Bone Currettes



16-131
JACOBSON
140 mm

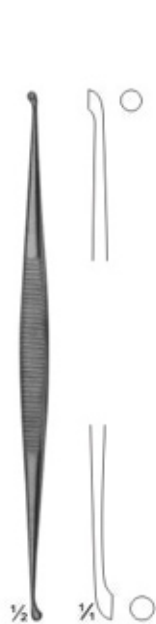

16-132
MARTINI
140 mm



16-133
MARTINI
140 mm



16-134
WILLIGER
145 mm



16-135
JANSEN
160 mm



16-136
BARTH
180 mm



16-137
VOLKMANN
130 mm

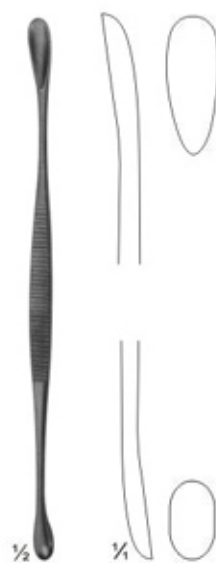

16-138
VOLKMANN
145 mm



16-139
VOLKMANN
170 mm

Mallets Weights refer to the heads of the mallets
Hammer Die Gewichtsangaben beziehen sich auf den Kopf des jeweiligen Hammers



∅ 20 mm

½

17-101
MEAD
 185 g
 with interchangeable
 plastic disks
 190 mm
17-102
 pair of spare disks



∅ 25 mm

½

17-103
 140 g
 with interchangeable
 plastic disks
 185 mm
17-104
 pair of spare disks



∅ 30 mm

½

17-105
COTTLE
 140 g
 1 Side Flat
 1 Side convex
 185 mm



∅ 22 mm

½

17-106
 165 g
 lead filled head
 190 mm

Osteotomes, Chisels and Gouges



17-107
MANNERFELT
Gouge
155 mm

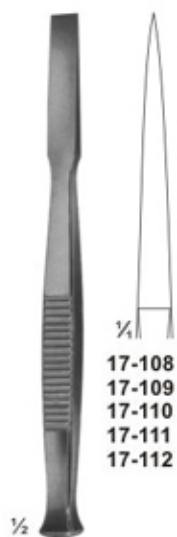

17-108 - 112
Osteotomes
140 mm

- 17-108 4 mm
- 17-109 6 mm
- 17-110 8 mm
- 17-111 10 mm
- 17-112 12 mm



17-113 - 117
Chisels
140 mm

- 17-113 4 mm
- 17-114 6 mm
- 17-115 8 mm
- 17-116 10 mm
- 17-117 12 mm



17-118 - 122
Gouges
140 mm

- 17-118 4 mm
- 17-119 6 mm
- 17-120 8 mm
- 17-121 10 mm
- 17-122 12 mm



PARTSCH
17-123 - 126
Chisels
140 mm

- 17-123 3 mm
- 17-124 4 mm
- 17-125 5 mm
- 17-126 6 mm

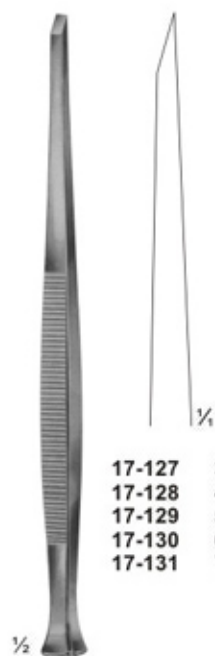

PARTSCH
17-127 - 131
Chisels
170 mm

- 17-127 3 mm
- 17-128 4 mm
- 17-129 5 mm
- 17-130 6 mm
- 17-131 7 mm



PARTSCH
17-132 - 135
Gouges
140 mm

- 17-132 3 mm
- 17-133 4 mm
- 17-134 5 mm
- 17-135 6 mm

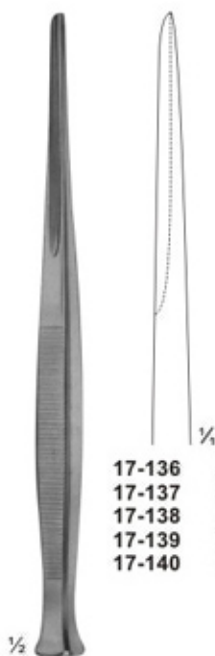

PARTSCH
17-136 - 140
Gouges
170 mm

- 17-136 3 mm
- 17-137 4 mm
- 17-138 5 mm
- 17-139 6 mm
- 17-140 7 mm



LUCAS
17-141 - 142
Chisels
160 mm

- 17-141 4 mm
- 17-142 6 mm



LUCAS
17-143 - 144
Gouges
160 mm

- 17-143 3 mm
- 17-144 5 mm

Reposition Forceps, Bone Holding Forceps



17-145
Patella forceps
185 mm



17-146
Forceps with
ratchet fixation
140 mm



17-147
Forceps with
thread fixation
170 mm



17-148
Forceps with
thread fixation
235 mm

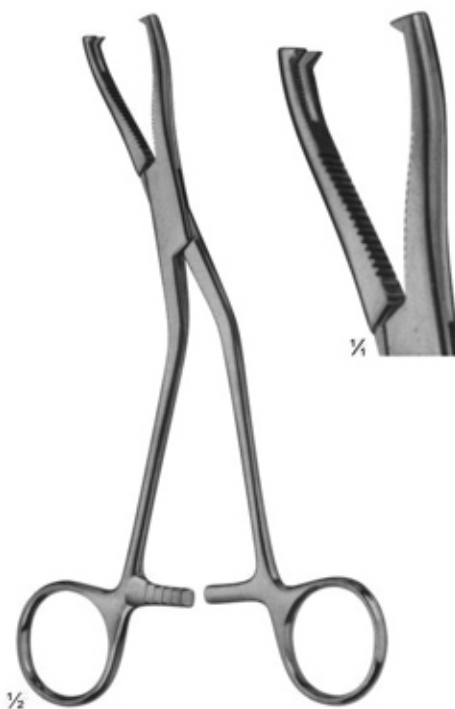

17-149
DINGMANN
185 mm

Bone Holding Forceps & Bone Clamps



Bone Rongeurs



17-158
LUER
150 mm



17-159
LUER
155 mm



17-160
BLUMENTHAL
155 mm



17-161
BLUMENTHAL
150 mm



17-162 - 163
JANSEN
175 mm

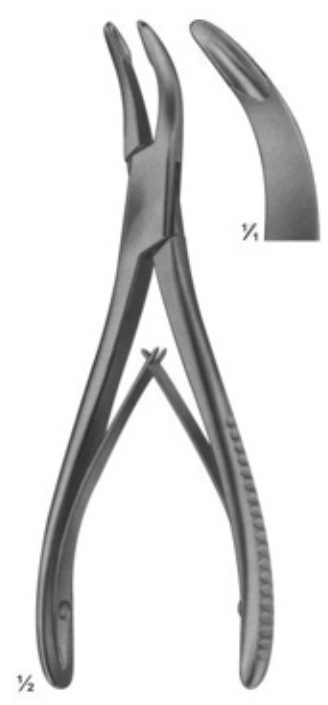

17-164
BANE-HARTMANN
175 mm

Bone Rongeurs



17-165
STILLE
235 mm



17-166
LEKSELL-STILLE
240mm



17-167
STILLE-RUSKIN
240mm

Bone Cutting Forceps



17-168
LISTON
curved on flat
240 mm

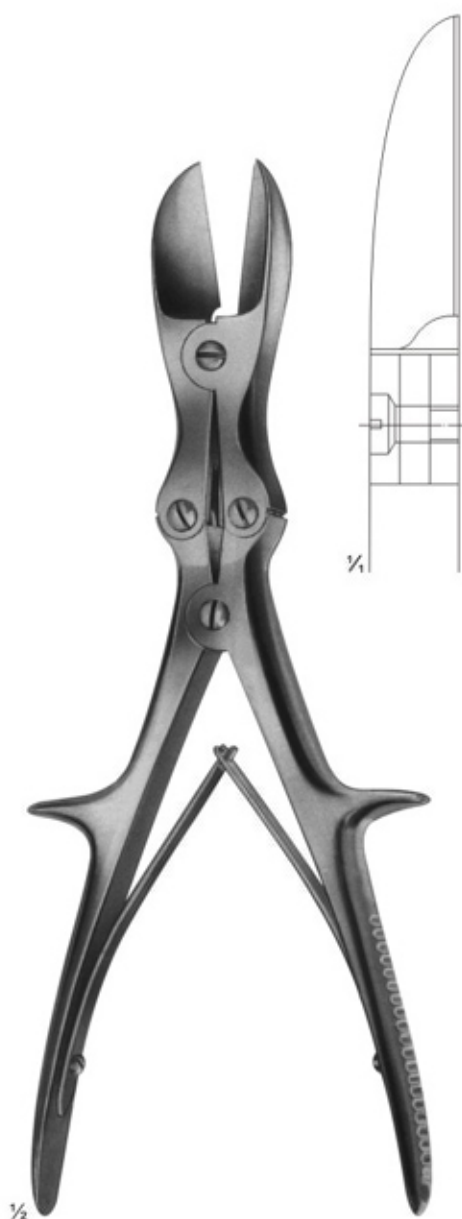

17-169
LISTON
straight
280 mm

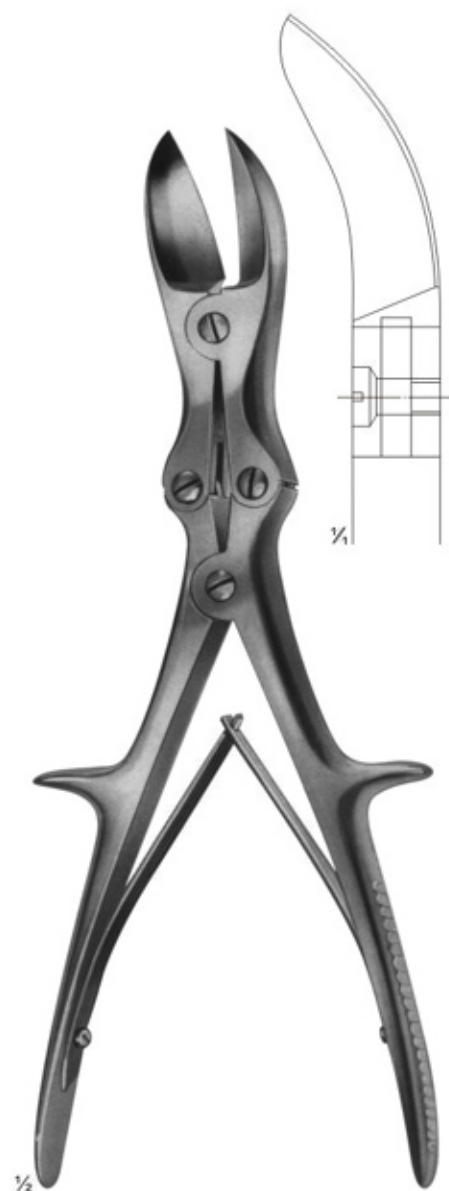

17-170
LISTON
curved on flat
280 mm

Wire Extension

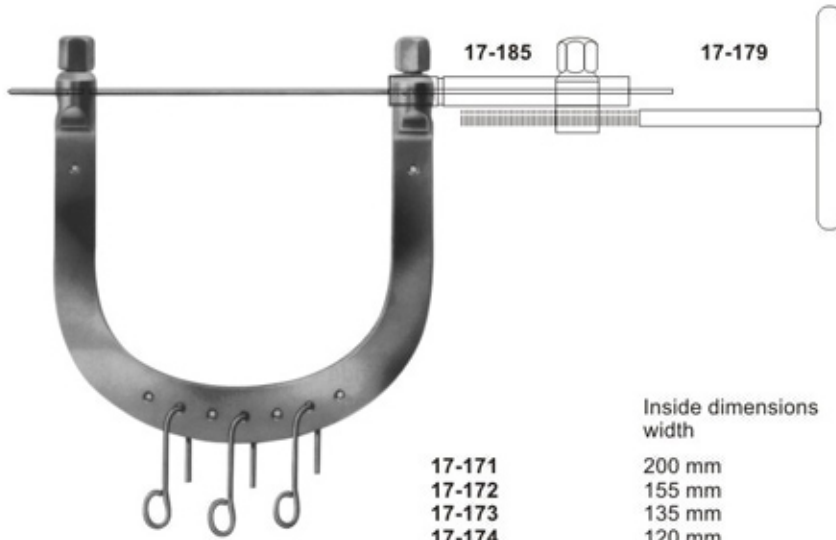

17-171 - 17-177
KIRSCHNER
 Wire traction bows,
 to be used with
KIRSCHNER-wires
 up to 2.5 mm diam.,
 With 3 hooks,
 stainless steel

	Inside dimensions width	depth	
17-171	200 mm	155 mm	for the hip
17-172	155 mm	155 mm	for the femur
17-173	135 mm	130 mm	for the knee
17-174	120 mm	120 mm	for the knee
17-175	105 mm	100 mm	for the knee
17-176	95 mm	110 mm	for the calcaneus
17-177	95 mm	70 mm	for the arm and elbow



17-178
 Wrench, double - ended,
 for wire traction bows



17-179
 Wire tightener, with
 clamping jaws



17-182	max. 105 mm
17-183	max. 160 mm
17-184	max. 200 mm
17-182	80-95 mm
17-183	90-120 mm
17-184	140-170 mm
diam upto	
17-182	1,6 mm
17-183	2,0 mm
17-184	2,5 mm

17-182 - 17-184
KIRSCHNER
 Wire traction bows, modified,
 adjustable in width, holds wire
 securely, with 1 hook



17-180
 Traction hook only,
 large size



17-181
 Traction hook only,
 small size



17-185
 Fixation clamp, to secure clamping
 jaws of 17-179 stainless steel

Cerclage Instruments

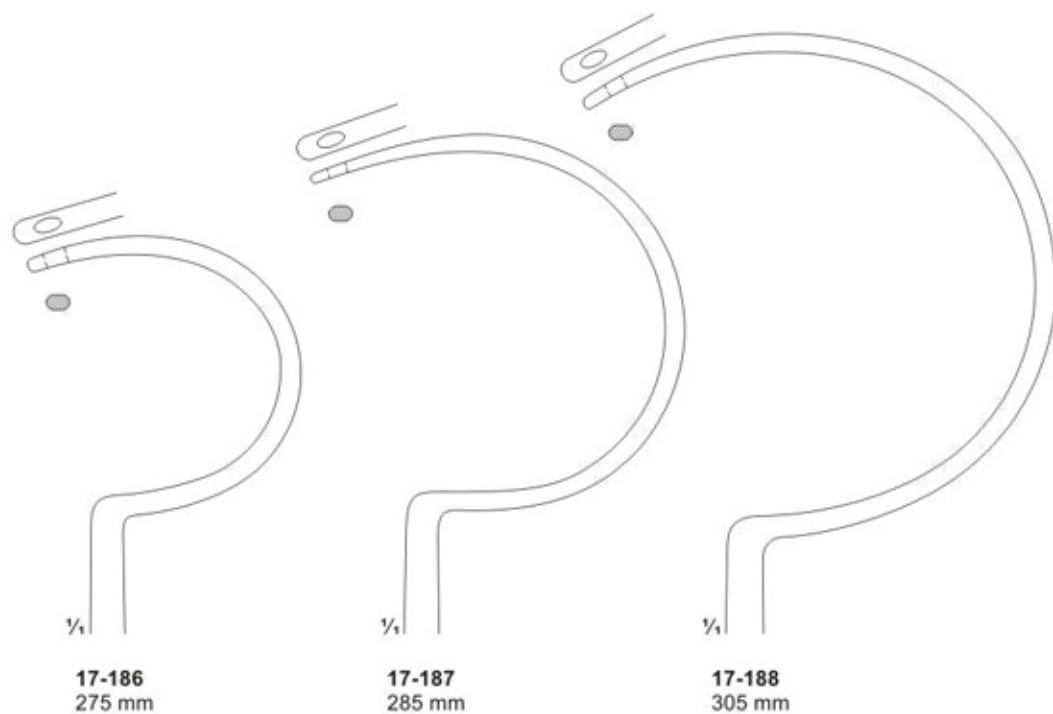

17-186 - 17-188
DEMEL
Wire guides

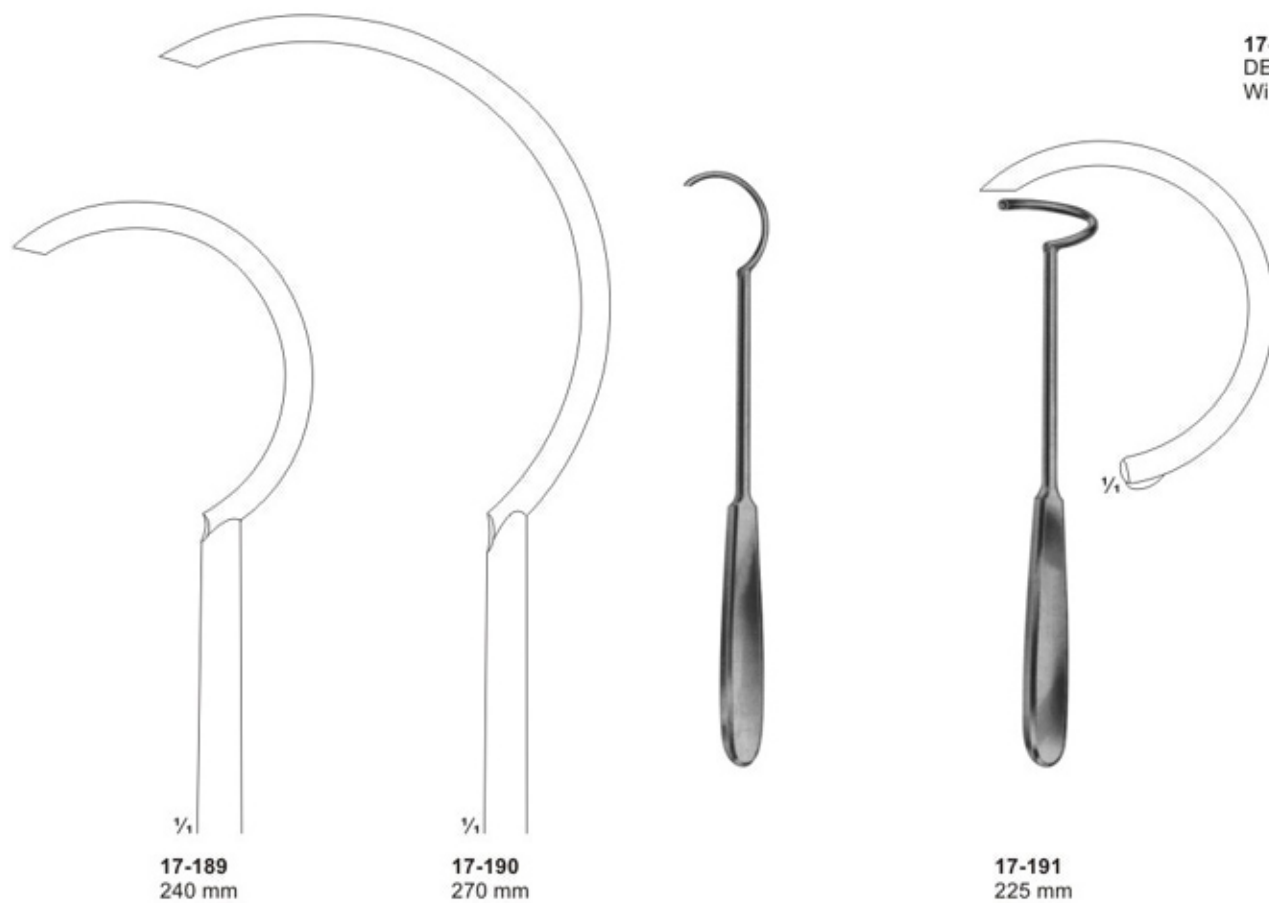

Wire Holding forceps, Wire Tightening Pliers, Flat-nosed Pliers DUROGRIP with Hard Metal Inserts



17-192
DUROGRIP
Holding forceps for cerclage wire, with lateral jaws to avoid wire slipping off
170 mm



17-193
DUROGRIP
Wire, tightening pliers, Ligature pliers
150 mm



17-194
DUROGRIP
Wire, tightening pliers, Ligature pliers
150 mm



17-195
with serrated jaws
140 mm



17-196
one jaw smooth, one jaw serrated
140 mm



17-197
with serrated jaws
17-198
with longitudinal and transversal grooves
170 mm



17-199
190 mm

**Wire Holding forceps, Flat-nosed Pliers,
Pliers for bending and cutting wires**

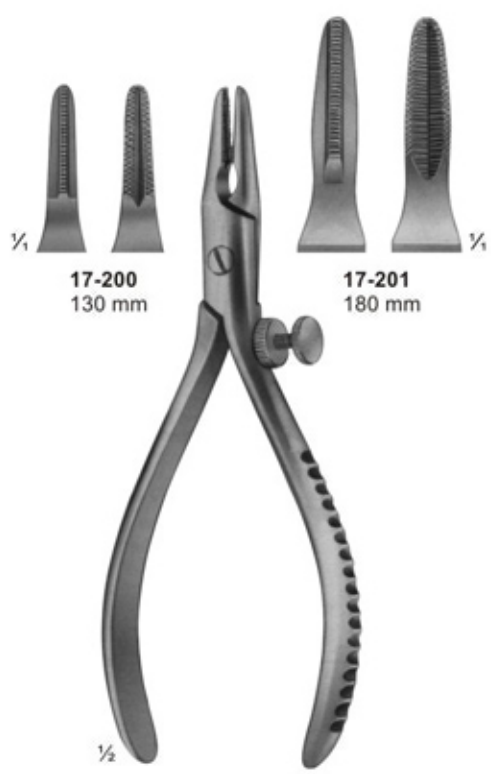

17-200
130 mm

17-201
180 mm

17-200 - 17-201
Extraction pliers
for boring wires



17-202
Flat-nosed pliers,
parallel
185 mm

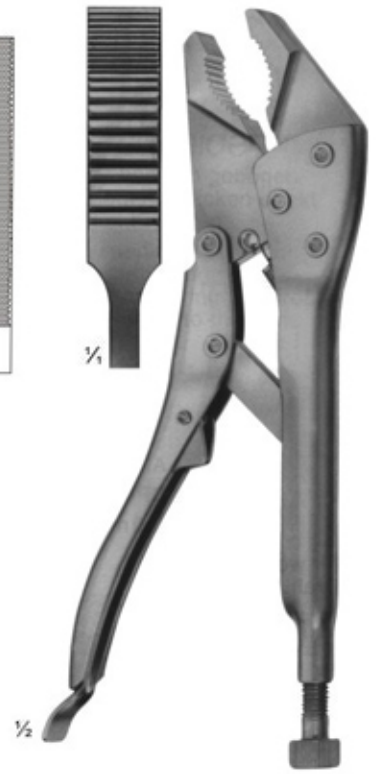

17-203
Vise grip
200 mm



17-204
Round Pliers
180mm

17-204 - 17-207

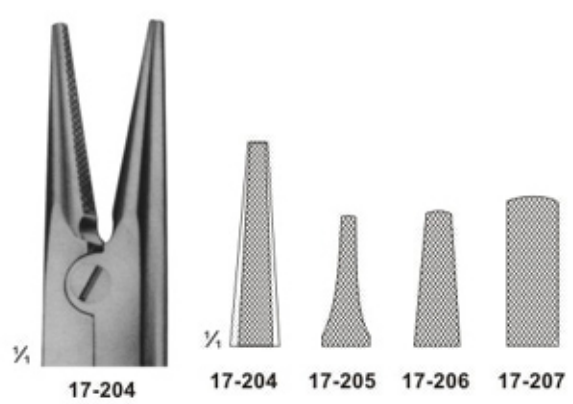

17-205 145 mm
17-206 180 mm
17-207 180 mm
Extraction pliers for wires



17-208
Bending pliers
for wires up to
1.8 mm diam.

Wire Cutters and wire Cutting Scissors

DUROTIP with Carbide Cutting Edges



17-209
ANGLE
130 mm

for soft wire
up to diam.
for hard wire
up to diam.

0,5 mm
0,3 mm

17-210
DUROTIP
ANGLE
130 mm

0,6 mm
0,4 mm

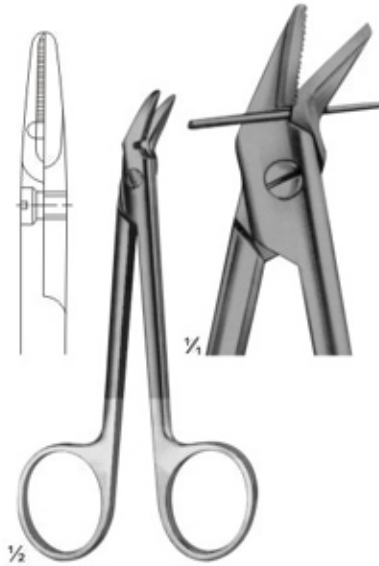

17-211
120 mm

for soft wire
up to diam.
for hard wire
up to diam.

1,2 mm
0,8 mm

17-212
DUROTIP
120 mm

1,2 mm
0,8 mm

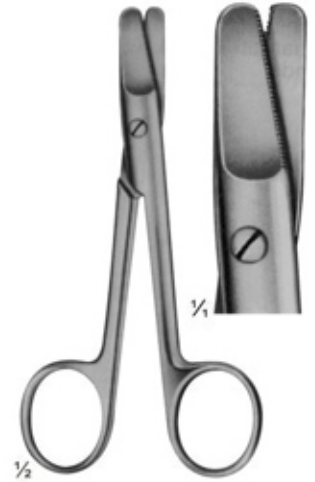

17-213
HARVEY
125 mm

0,4 mm
0,3 mm



17-214
150 mm

for soft wire
up to diam
for hard wire
up to diam

1,5 mm
1,0 mm



17-215
160 mm

1,5 mm
1,2 mm



17-216
140 mm
DUROTIP
1,5 mm

1,0 mm

Wire Cutting Pliers, Lateral Cutting Action



17-217
180 mm

for soft wire
up to diam. 2,0 mm
For hard wire 1,5 mm
up to diam
specially hardened
cutting edges, front
and lateral cutting
action



17-218
REILL
175 mm

for soft wire
up to diam. 2,0 mm
For hard wire 1,6 mm
up to diam
specially hardened
cutting edges, for
cutting off wires close
to the bone



DUROTIP

17-219
235 mm

for soft wire
up to diam. 3,0 mm
For hard wire 2,2 mm
up to diam

Wire Cutting Pliers, Lateral and Front Cutting Action



17-220
240 mm

for soft wire up to diam. 2,0 mm
For hard wire up to diam 1,6 mm



17-221
145 mm

for soft wire up to diam. 1,5 mm
For hard wire up to diam 1,0 mm



17-222
145 mm

for soft wire up to diam. 2,0 mm
For hard wire up to diam 1,5 mm



17-223
220 mm

for soft wire up to diam. 3,5 mm
For hard wire up to diam 2,5 mm

Wire Cutting Pliers



17-224
320 mm

for soft wire
up to diam. 3,0 mm
For hard wire
up to diam. 3,0 mm



Cutter for cutting off
KIRSCHNER wires,
Tibia head screws,
bolts, pins, up to 3 mm diam.



DUROTIP

17-225
Cutter for cutting off
KIRSCHNER wires,
Tibia head screws,
bolts, pins, up to 6 mm diam.
470 mm

Finger Nail Instruments

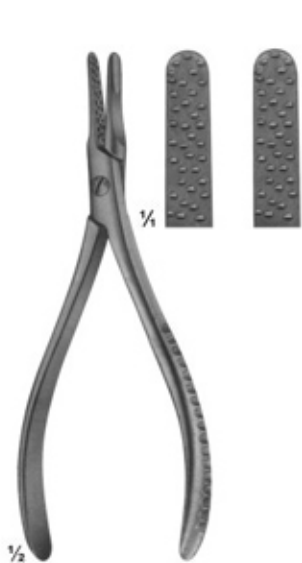

17-226
Nail extracting
forceps
135 mm



17-227
Nail extracting
forceps
145 mm

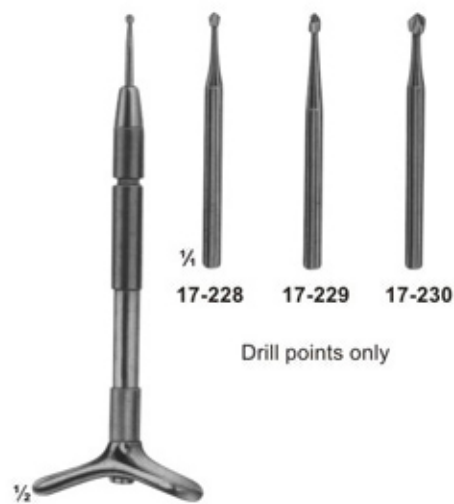

17-228
Finger nail drill
with 3 drill points

Drill points only

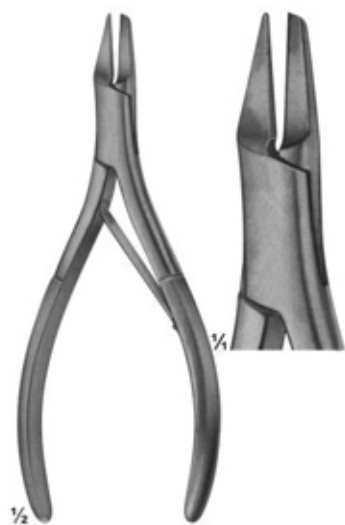

17-231
Nail splitting
forceps
135 mm



17-232
SYSTRUNK
Scissors, for splitting
finger nails
130 mm



17-233
Finger ring saw
150 mm

Spare blade
17-234

Plaster Shears



17-235
STILLE-AESCULAP
260 mm



17-236
STILLE-AESCULAP
360 mm

Plaster Spreader, Plaster Breakers



17-237
HENING
270 mm



17-238
MOD.USA
230 mm



17-239
290 mm



with removable jaws



17-240 - 17-241
WOLFF
17-240 180 mm
17-241 240 mm
plaster breakers

Vacuum Curettes for Aspiration Lipectomy, Suction Instruments

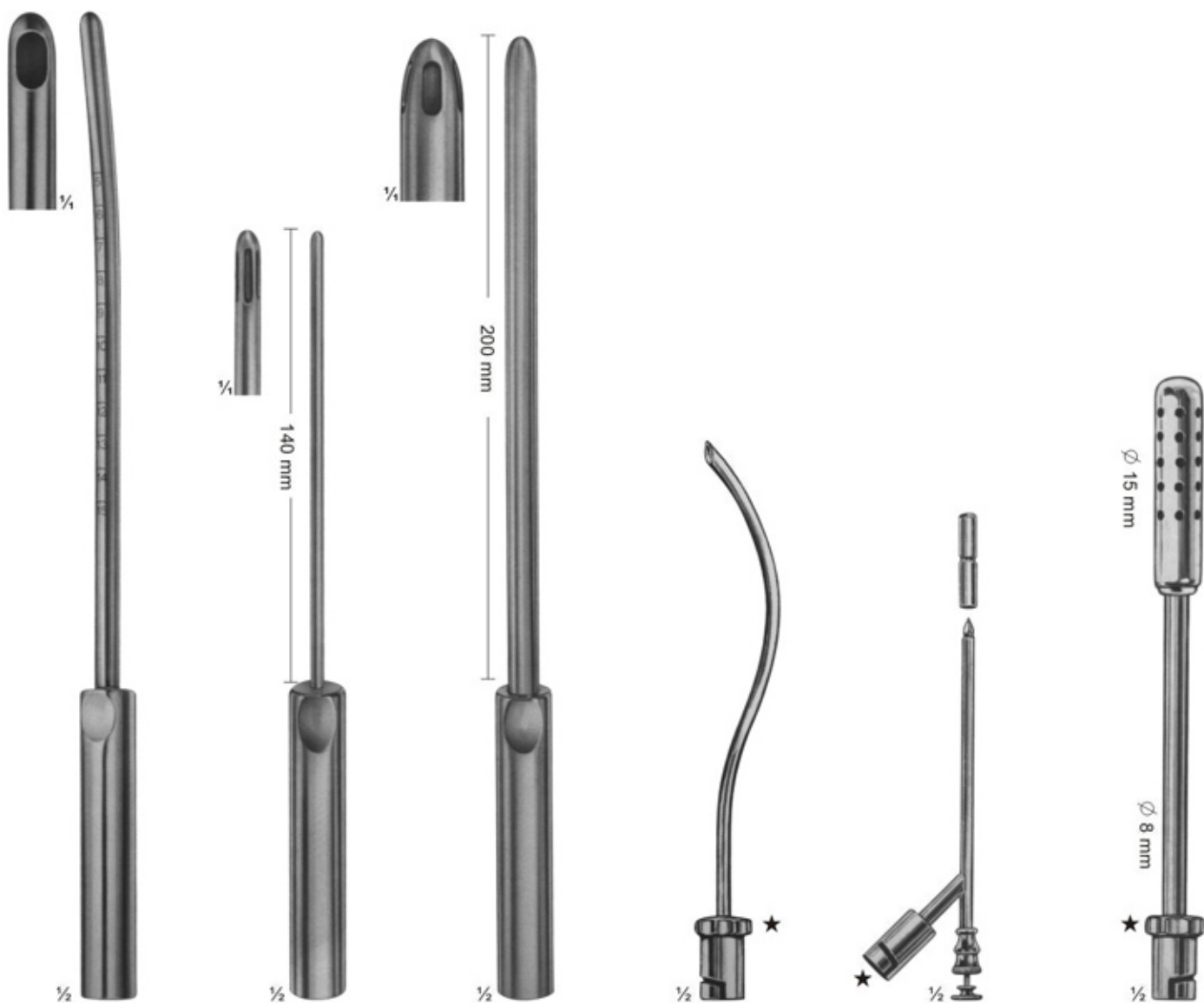

18-101 - 18-106
 BIEMER
 18-101 \varnothing 4 mm
 18-102 \varnothing 6 mm
 18-103 \varnothing 8 mm
 18-104 \varnothing 10 mm
 18-105 \varnothing 12 mm
 18-106 \varnothing 14 mm
 Curettes for aspiration lipectomy, graduated, slightly curved

18-107 - 18-108
 BIEMER
 18-107 \varnothing 4 mm
 18-108 \varnothing 6 mm
 Curettes for aspiration lipectomy, with three apertures, slightly curved malleable

18-109 - 18-111
 BIEMER
 18-109 \varnothing 8 mm
 18-110 \varnothing 10 mm
 18-111 \varnothing 12 mm
 Curettes for aspiration lipectomy, with three apertures, slightly curved malleable

18-112
 For aspirating fluid from the excretory ducts of large glands and for keeping the operating area clear
 170 mm

18-113
 Trocar
 For puncturing
 150 mm

18-114
 For clearing large quantities of fluid
 190 mm

Suction Instruments

18-115 150mm
Suction handle, with vacuum regulator and finger cut-off, brass, mirror-finish chromium-plated



olive
Ø9 mm

18-116 170mm
Suction handle, with hand regulation valve and quick-shutter, brass, mirror-finish chromium-plated



Both suction handles have bayonet fitting Olive and can be used for the suction cannulae. Ø9 mm



18-117
Trocar
For puncturing
170 mm



18-118
Hollow needle,
sharp
150 mm



18-119
double curved
For general
surgery
230 mm



18-120
For tonsillectomy,
oral and laryngeal
operations
190 mm



18-121
For tonsillectomy,
oral and laryngeal
operations
220 mm

★ With bayonet fitting to be used with suction handles (18-115 - 18-116)

Suction Instruments

18-122
WULLSTEIN
 Suction tube, conical, silver, olive
 with LUER hub
 160 mm



18-123 1,5 mm
18-124 2,0 mm
WULLSTEIN
 Suction tube, cylindrical, silver, with
 stylet olive with LUER hub
 160 mm



Usable length

YASARGIL usable length diam.		YASARGIL usable length diam.	
18-125	130 mm 1,5 mm	18-133	130 mm 2,5 mm
18-126	150 mm 1,5 mm	18-134	150 mm 2,5 mm
18-127	180 mm 1,5 mm	18-135	180 mm 2,5 mm
18-128	220 mm 1,5 mm	18-136	220 mm 2,5 mm
18-129	130 mm 2,0 mm	18-137	130 mm 3,5 mm
18-130	150 mm 2,0 mm	18-138	150 mm 3,5 mm
18-131	180 mm 2,0 mm	18-139	180 mm 3,5 mm
18-132	220 mm 2,0 mm	18-140	220 mm 3,5 mm
		18-141	180 mm 4,5 mm

olive
 ϕ 6,5-9 mm
 with LUER hub

18-142 - 18-144
LANDOLT
 150 MM
 diam ϕ 3 mm

18-142 8 mm / curved
18-143 11mm / curved
18-144 15mm / curved

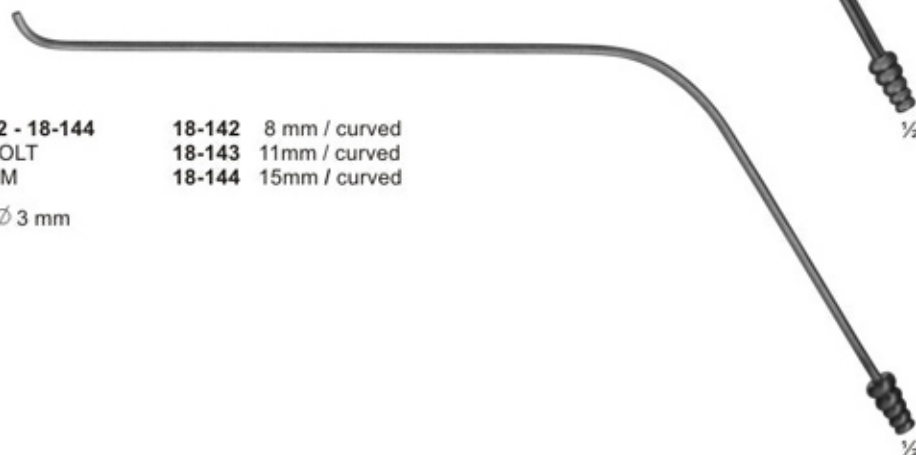

18-145 500 mm
18-146 350 mm
 with rubber tip,
 with LUER hub

olive ϕ 9 mm

18-147 2,0 mm diam
18-148 2,5 mm diam
18-149 3,0 mm diam
 with finger cut-off,
 thumb piece 90° to
 curve, with LUER hub
 250 mm

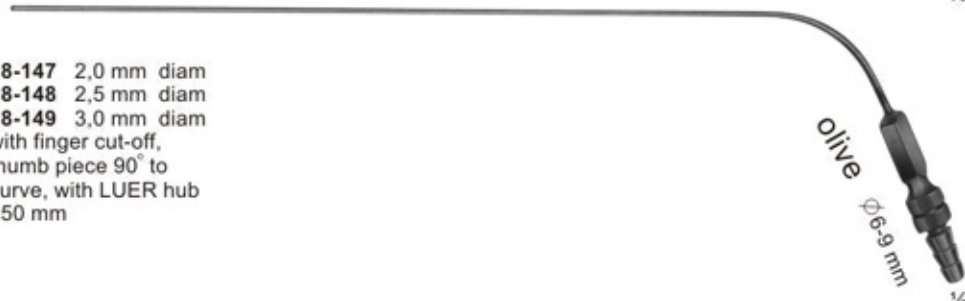

Combined Suction and Irrigation Cannulae, Coagulation Suction Cannulae

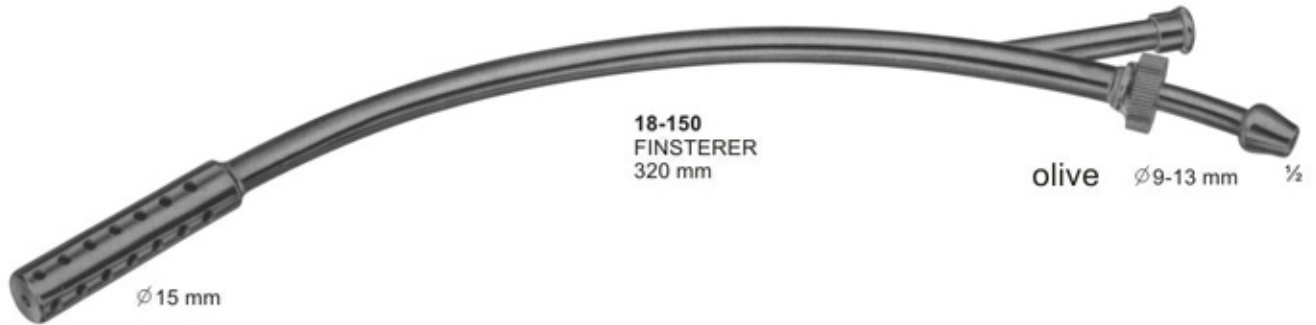

18-150
FINSTERER
320 mm

olive $\varnothing 9-13\text{ mm}$ $\frac{1}{2}$



18-151
YASARGIL
LUER-LOCK cone
200 mm

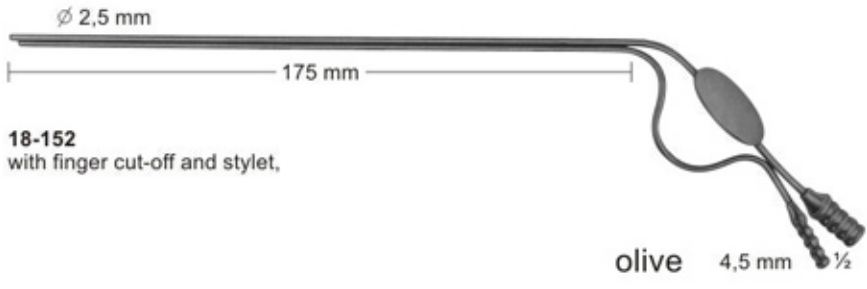

18-152
with finger cut-off and stylet,

olive 4,5 mm $\frac{1}{2}$



18-153 - 18-155
HOUSE

	suction tube diam.	irrigation tube Diam.
18-153	0,9 mm	0,7 mm
18-154	1,2 mm	0,9 mm
18-155	1,5 mm	1,2 mm

with finger cut-off and stylet, with LUER hub

$\varnothing 4\text{ mm}$
olive $\varnothing 9-6\text{ mm}$ $\frac{1}{2}$

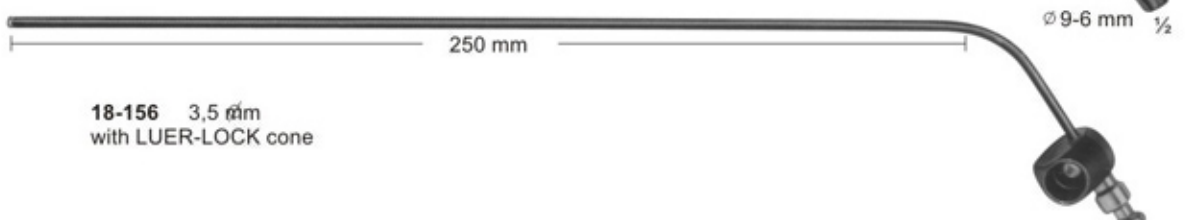

18-156 3,5 mm
with LUER-LOCK cone

olive $\varnothing 9\text{ mm}$ $\frac{1}{2}$



18-157 $\varnothing 5,0\text{ mm}$
LANDOLT
with finger cut-off and stylet, can be sterilized in an autoclave up to 3 bar (143 °C)

Connection for suction hose

$\varnothing 7,5-12\text{ mm}$
olive

4 mm diam., Untarnished contact to be touched by HF-electrodes

Suction Instruments

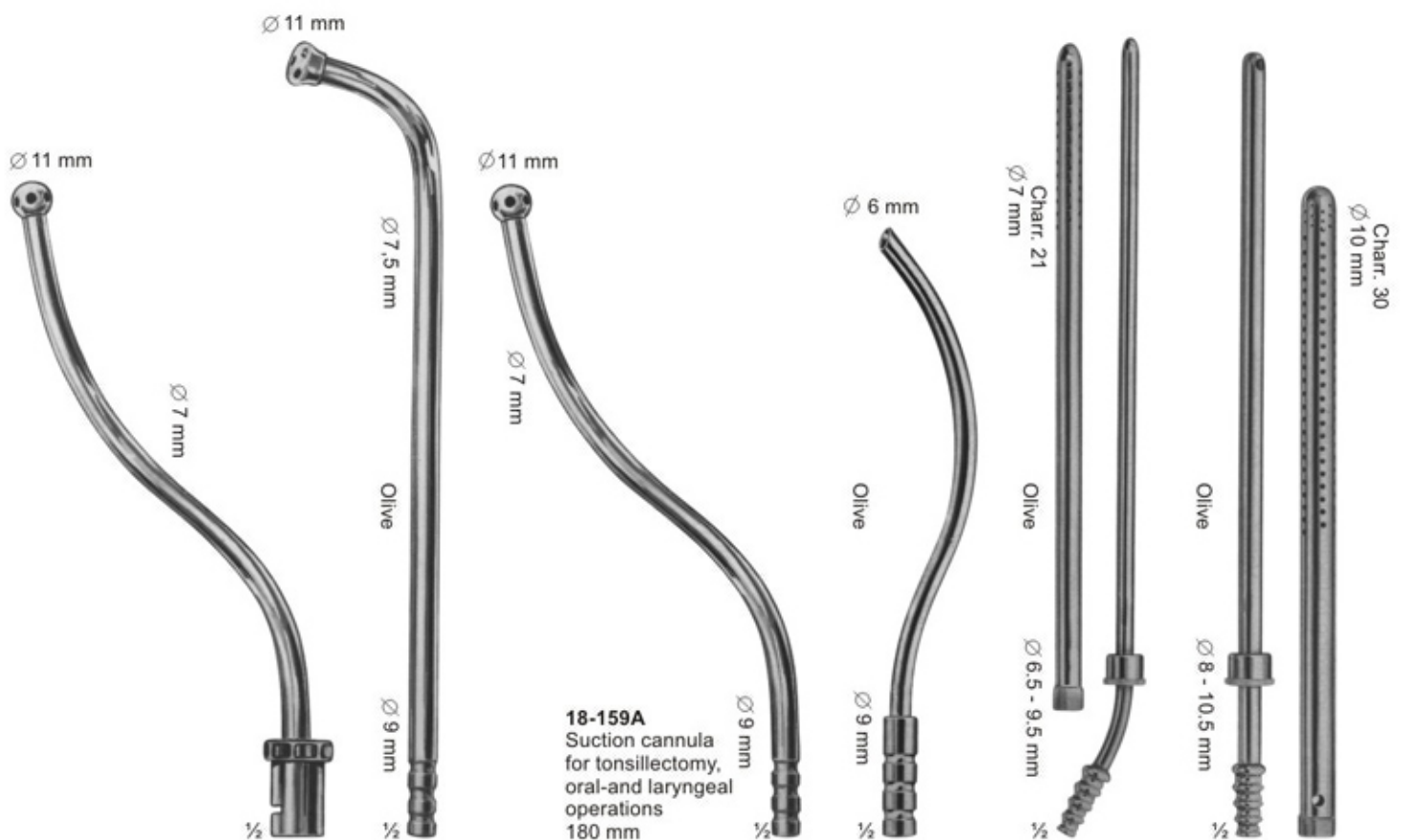

18-158
For tonsillectomy,
oral-and laryngeal
operations
180 mm

18-159
Suction cannula
for tonsillectomy,
oral-and laryngeal
operations
220 mm

18-159A
Suction cannula
for tonsillectomy,
oral-and laryngeal
operations
180 mm

18-160
S-shaped blunt cannula
for aspirating fluid from
the excretory ducts of
large glands and for
keeping the operating
area clear
170 mm

18-161
POOL
Suction cannula,
with outer tube
to be screwed off
225 mm

18-162
POOL
Suction cannula,
with outer tube
to be screwed off
225 mm

Suction Instruments

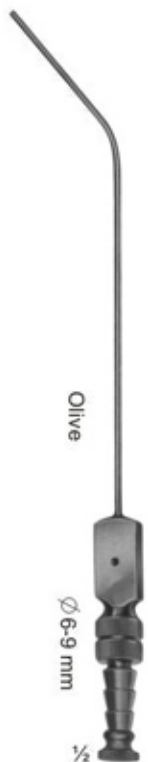

- 18-163 \varnothing 1,5 mm
- 18-164 \varnothing 2,0 mm
- 18-165 \varnothing 2,5 mm
- 18-166 \varnothing 3,0 mm

18-163 - 18-166
PLESTER
 with finger cut-off and
 stylet, thumb piece
 parallel to curve, with
 LUER hub
 195 mm



- 18-167 \varnothing 2,0 mm
- 18-168 \varnothing 2,5 mm
- 18-169 \varnothing 3,0 mm
- 18-170 \varnothing 4,0 mm
- 18-171 \varnothing 5,0 mm

18-167 - 18-171
FERGUSSON
 with finger cut-off and
 stylet, thumb piece
 90° to curve, with
 LUER hub
 180 mm



18-172 \varnothing 4,0 mm
FERGUSSON
 with finger cut-off
 and stylet, thumb piece 90°
 to curve, with LUER hub
 180 mm



18-173 \varnothing 3,0 mm
18-174 \varnothing 5,0 mm
FRAZIER
 insulated, with finger
 cut-off and stylet, thumb
 piece 90° to curve,
 with LUER hub
 180 mm

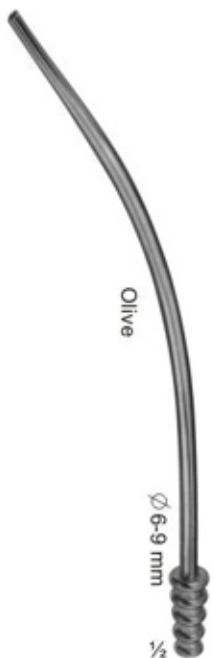

18-175
 5,0 mm diam., Tip
 6,5 mm wide, Nasal
 suction tube, with
 LUER hub
 180 mm



18-176 \varnothing 4,5 mm
18-177 \varnothing 5,5 mm
 Nasal suction
 tubes
 175 mm



18-178
GORNEY
 Suction dissector
 180 mm



18-179 4 mm wide
18-180 5 mm wide
 Suction raspatories,
 sharp, bayonet-shaped,
 with stylet
 200 mm



18-181
LOPEZ-REINKE
 Tonsil dissector with
 suction device
 235 mm

Dissection Instruments

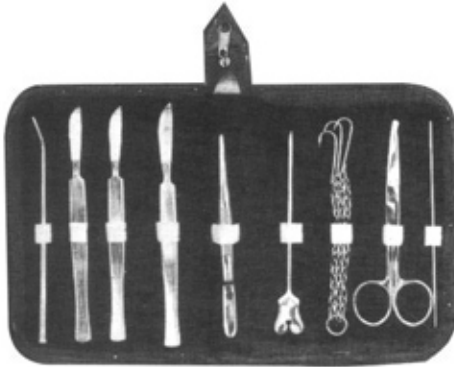

18-182

- 1- Blow pipe .
- 2- 3 PCS .scalpel.
- 3- Dissecting forcep 13 cm.
- 4- Grooved director with tounge tie 13 cm.
- 5- Triple chain hook.
- 6- Dressing scissors probe pointed 13 cm.
- 7- Probe double 13 cm.
- 8- Zipper case inside red velvet.

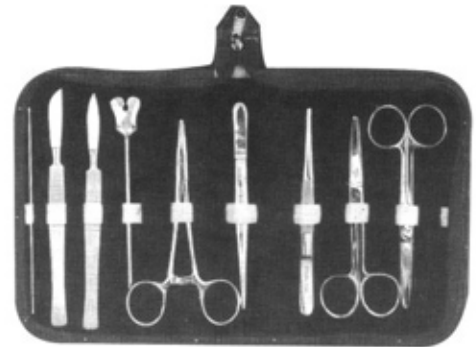

18-183

- 1- Probe Double 13 cm
- 2- 2 PCS. Scalpel S.S
- 3- Grooved Director With tongue Tie 13 cm
- 4- Mayo Hegar Needle Holder 13cm
- 5- Discting Forcep 13 cm 1x2 Teeth
- 6- Dressing Forcep 13 CMS Serrated.
- 7- Dressing Scissor 13 cm S/B STR.
- 8- Dressing Scissor 13 cm S/B CVD.
- 9- Zipper Case Inside Red Velvet.

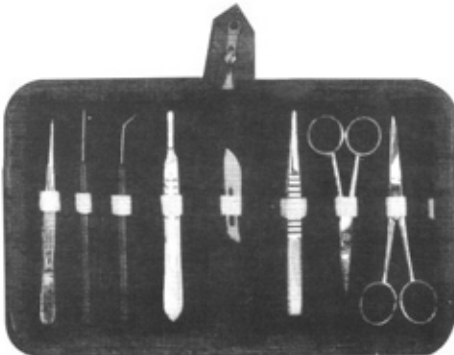

18-184

- 1- Dissecting Forcep 11.5 cm Sharp Point.
- 2- Iris Scissor
- 3- B.P Handle No. 4
- 4- Teasing Needle Sharp angular.
- 5- Blade No. 22
- 6- Thumb Forceps T.O.E 13 cm
- 7- Dissecting Scissor STR 11.5 cm
- 8- Dissecting Scissor STR 13 cm
- 9- Zipper case Inside Red Velvet



18-185

- 1- Grooved Director with Tongue Tie 14 cm
- 2- Probe Double 14cm
- 3- Mayo Hegar Needle Holder 14 cm
- 4- BP. Handle no.3
- 5- BP. Handle no.4
- 6- Dressing Scissor 14 cm S/B STR
- 7- Dressing Scissor 14 cm S/B CVD.
- 8- Dressing Forcep 1x2 Teeth 14 cm
- 9- Dressing Forcep Serrated 14 cm

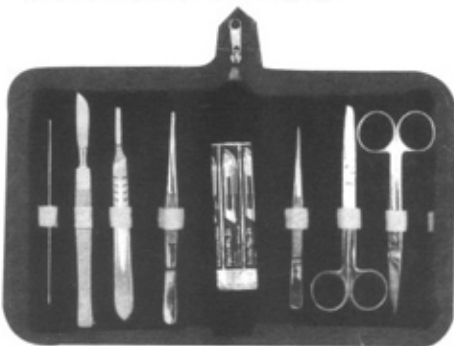

18-186

- 1- Probe double 12.5 cm
- 2- Scalpel
- 3- B.P Handle No. 4
- 4- 6 PCS Blade 2 each no. 21, 22, 23
- 5- Dissecting Forcep 12.5 cm
- 6- Dissecting Forcep 11.5 cm sharp Point
- 7- Dissecting Scissor S/B STR 13 cm
- 8- Dissecting Scissor S/S STR 13 cm



18-187

- 1- Teasing Needle with Chuck CVD.
- 2- Huber Probe
- 3- Iris Scissor
- 4- Dissecting Forcep Fine 14 cm.
- 5- Dissecting Forcep Fine CVD. 12 cm
- 6- Operating Scissor with Probe 14 cm.
- 7- B.P. Handle no. 4

Dissection Instruments



18-188

- 1- Probe with eye
- 2- Dissecting Forcep cvd fine 12 cm.
- 3- Iris Scissor
- 4- Operating Scissor S/B str 14 cm
- 5- Grooved Director and Tongue tie
- 6- Huber Probe
- 7- Triple Chain Hook
- 8- B.P Handle No. 4
- 9- B.P Handle No. 3
- 10- Teasing Needle with Chuck cvd.
- 11- Teasing Needle with Chuck str.
- 12- Dissecting Forceps Fine 14 cm.

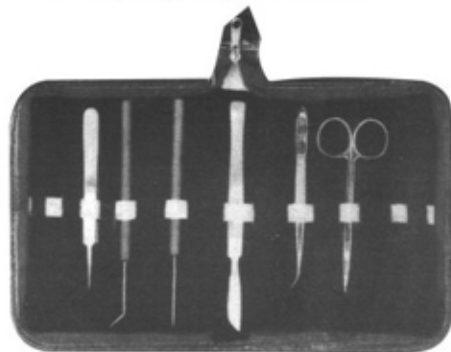

18-190

- 1- Iris Scissor STR
- 2- Dissecting Forceps CVD 12 cm.
- 3- Scalpel
- 4- Teasing Needle STR wooden handle.
- 5- Teasing Needle CVD wooden handle.
- 6- Watchmaker fine point.

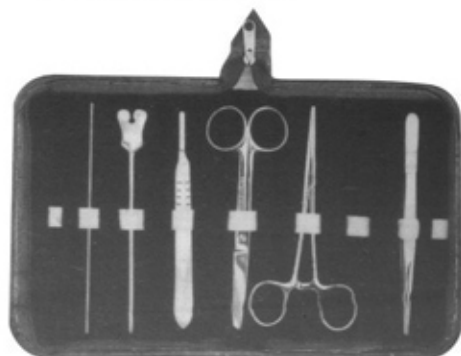

18-192

- 1- Probe double end.
- 2- Grooved director and tongue tie.
- 3- B.P handle no.4
- 4- Operating scissor STR S/b14cm.
- 5- Kelly forceps STR 14cm.
- 6- Dissecting forceps thumb 13cm.

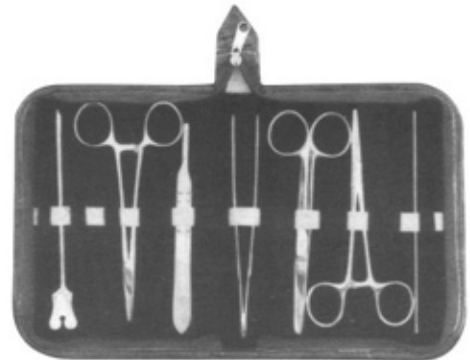

18-189

- 1- Grooved Director and Tongue tie
- 2- Mayo Hearn Needle Holder 14 cm
- 3- B.P Handle No. 4
- 4- Dissecting Forceps Thumb 14 cm.
- 5- Operating Scissor S/B str 14 cm
- 6- Kelly Forcep STR 14 cm.
- 7- Probe Double end

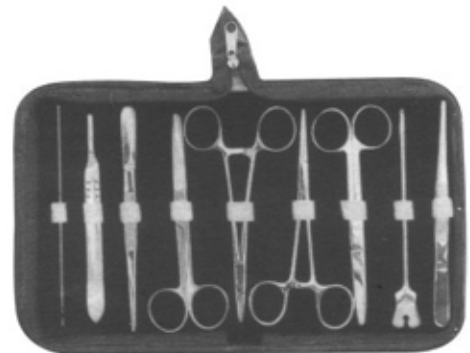

18-191

- 1- Probe Double end
- 2- B.P Handle No. 4
- 3- Dissecting Forcep 1x2 Teeth 14 cm.
- 4- Operating Scissor S/B str 14 cm
- 5- Mayo Hearn Needle Holder 14 cm
- 6- Kelly Forcep STR 14 cm.
- 7- Operating Scissor S/B CVD 14 cm
- 8- Grooved Director and Tongue tie
- 9- Dissecting Forceps Thumb 14 cm.

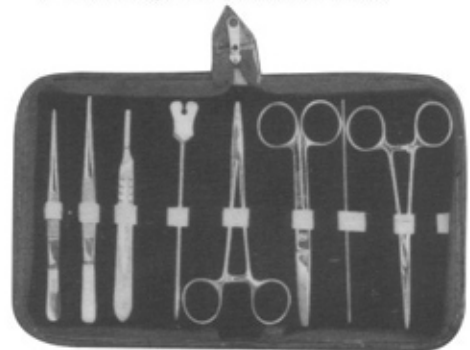

18-193

- 1- Dissecting Forceps Thumb 14 cm
- 2- Dissecting Forcep 1x2 Teeth 14 cm.
- 3- B.P Handle No. 3
- 4- Grooved Director and Tongue tie
- 5- Mayo Hearn Needle Holder 14 cm
- 6- Operating Scissor S/B str 14 cm
- 7- Probe Double end
- 8- Kelly Forcep STR 14 cm.

Dissection Instruments

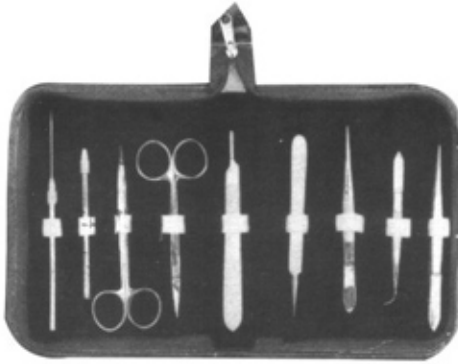

18-194

- 1- Dissecting Forcep Fine 14cm.
- 2- Dissecting Forcep Fine CVD 12cm
- 3- Dissecting Forcep with Pin 14cm.
- 4- Watchmaker Fine point
- 5- Iris scissor STR
- 6- Iris scissor CVD.
- 7- Teasing Needle holder
- 8- Teasing Needle STR.
- 9- B.P. Handle no. 3



18-195

- 1- Teasing Needle STR.
- 2- Grooved Director and Tongue Tie.
- 3- Teasing Needle CVD.
- 4- Dissecting Forcep with Pin 12 cm Fine
- 5- Operating Scissor S/B STR 14 cm
- 6- Triple Chain Hook
- 7- Probe with eye
- 8- Probe Double end
- 9- Probe and Hook
- 10- Dissecting Forcep Fine 14 cm
- 11- Iris Scissor
- 12- Huber Probe
- 13- B.P. Handle no.3
- 14- B.P. Handle no.4



18-196

- 1- Dissecting forcep fine STR with pin 12cm.
- 2- Iris scissor STR.
- 3- Probe with eye.
- 4- Probe and hook.
- 5- Operating scissor S/B STR 14cm
- 6- Triple chain hook.
- 7- B.P. handle no.4
- 8- Humber probe.
- 9- B.P.handle no.3
- 10- Teasing needle STR plastic handle.
- 11- Teasing needle CVD plastic handle.
- 12- Grooved director and tongue tie.
- 13- Probe double end.



18-197

- 1- Dissecting Forceps Thumb 14 cm.
- 2- Dissecting Forcep 1x2 Teeth 14 cm.
- 3- B.P Handle No. 3
- 4- Grooved Director and Tongue tie
- 5- Mayo Hearn Needle Holder 14 cm
- 6- Operating Scissor S/B str 14 cm
- 7- Probe Double end
- 7- Kelly Forcep STR 14 cm.

Hospital Wares



19-101 - 115
Schimmelbusch

	Ø x H sizes in mm
19-101	80 x 80
19-102	105 x 120
19-103	140 x 140
19-104	160 x 120
19-105	160 x 150
19-106	190 x 150
19-107	190 x 190
19-108	240 x 160
19-109	240 x 240
19-110	290 x 160
19-111	290 x 240
19-112	340 x 160
19-113	340 x 340
19-114	390 x 190
19-115	390 x 290



19-116
Box
120 x 65 x 13mm
(without Bulldog clamps,
without silicone tape)



19-117
Box with support
120 x 65 x 13 mm
(ohne Bulldogklemmen)



19-118
Box with support for
needle electrodes,
without instruments

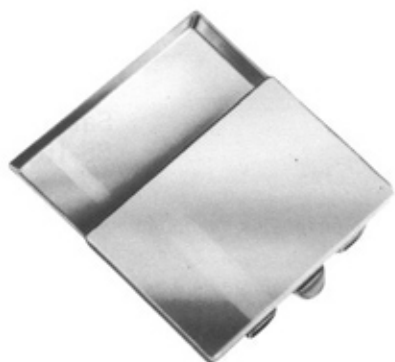

19-119 - 121
50 x 25 x 4,5 mm
19-120
65 x 42 x 8 mm
19-121
75 x 25 x 4,5 mm



19-122
Ø 65mm x 15mm

Hospital Wares



19-123 - 131

	Ø x H
19-123	30 x 90 mm
19-124	50 x 100 mm
19-125	50 x 130 mm
19-126	50 x 175 mm
19-127	75 x 100 mm
19-128	75 x 130 mm
19-129	75 x 175 mm
19-130	100 x 175 mm
19-131	100 x 200 mm



19-141 - 142

- 19-141** Martin Sterilizing Forceps consisting of:
 1 Sterilizing Forceps, curved, 25 cm, without ratchet, with lid for jar
 1 jar with bottom plate (anti-tilt)
- 19-142** ditto, with 32 cm long Sterilizing Forceps



19-132 - 139

19-132	165 x 85 x 35 mm
19-133	200 x 100 x 35 mm
19-134	200 x 100 x 50 mm
19-135	230 x 130 x 50 mm
19-136	260 x 150 x 50 mm
19-137	270 x 235 x 50 mm
19-138	300 x 200 x 50 mm
19-139	325 x 275 x 50 mm



19-140
 205 x 105 x 35 mm

Round Metal Boxes and Medicine Cups



19-143 - 148

∅ x H

19-143	75 x 60 mm
19-144	75 x 75 mm
19-145	100 x 60 mm
19-146	100 x 100 mm
19-146A	125 x 80 mm
19-147	125 x 125 mm
19-148	150 x 150 mm



19-149
25 cc

19-150
50 cc



19-151
20 cc
Medicine Spoon



19-152
∅ 75 x 12 mm
Tablet Tray



19-153
∅ 90 x 90 mm
Metal Cup



19-154
∅ 75 x 80 mm
Sputum Cup



Kidney Dish



19-155 - 157

19-155	170 x 100 x 35 mm
19-156	250 x 140 x 40 mm
19-157	275 x 150 x 45 mm

Hospital Wares



19-158 - 165



19-166 - 170

	Ø x H	
19-158	40 x 19 mm	0.05L
19-159	61 x 30 mm	0.07L
19-160	80 x 40 mm	0.14L
19-161	116 x 50 mm	0.35L
19-162	128 x 55 mm	0.45L
19-163	147 x 65 mm	0.70L
19-164	167 x 75 mm	1.10L
19-165	187 x 85 mm	1.60L

19-166	116 x 35 mm	0.30L
19-167	128 x 38 mm	0.40L
19-168	147 x 40 mm	0.50L
19-169	157 x 45 mm	0.75L
19-170	187 x 45 mm	1.00L



19-171
Ø 110 x 28 mm 0.15L



19-172
100 cc 0.1L



19-173 - 176
19-173 0,25L
19-174 0,50L
19-175 1,00L
19-176 2,00L



19-177
235 x 190 x 40 mm



19-178
Ø 220 x 70 mm

Hospital Wares



19-179
 ∅ 50 x 100 mm
 Powder Pot



19-180
 ∅ 50 x 75 mm
 Methot With Lid



19-181
 ∅ 50 x 75 mm
 Methot Without Lid



19-182



19-183



19-184

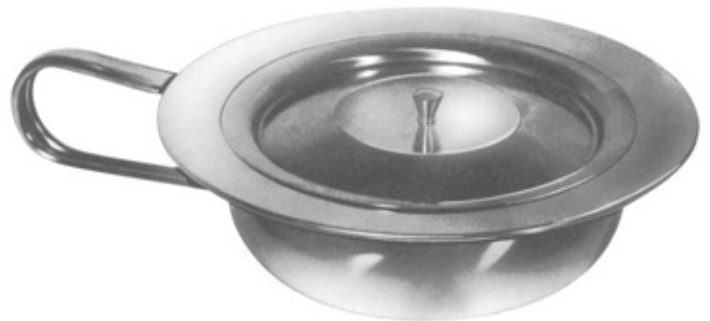

19-185 - 186

19-185 ∅ 235 mm
19-186 ∅ 310 mm

Needle Cases



19-187
Sauerbruch
210 x 125 x 17 mm



19-188
Sauerbruch
210 x 125 x 17 mm



19-189
150 x 95 x 13 mm



19-190
150 x 95 x 13 mm



19-191
150 x 95 x 13 mm



19-192
150 x 95 x 13 mm



19-193
150 x 95 x 13 mm



19-194
150 x 95 x 13 mm



19-195
150 x 95 x 11 mm

Storing Cases



19-199 - 209

19-199	230 x 130 x 50	mm
19-200	260 x 150 x 50	mm
19-201	275 x 235 x 50	mm
19-202	300 x 200 x 50	mm
19-203	325 x 275 x 50	mm
19-204	420 x 175 x 50	mm
19-205	230 x 130 x 75	mm
19-206	260 x 150 x 75	mm
19-207	300 x 200 x 75	mm
19-208	325 x 275 x 75	mm
19-209	420 x 175 x 75	mm



19-196
Deponette
245 x 135 x 35mm



19-197
Deponette
245 x 135 x 50mm



19-198
Deponette
245 x 135 x 60mm

Sterilizing Baskets / Trays



19-210 - 212

19-210	480 x 250 x 50	mm
19-211	520 x 250 x 75	mm
19-212	520 x 250 x 100	mm

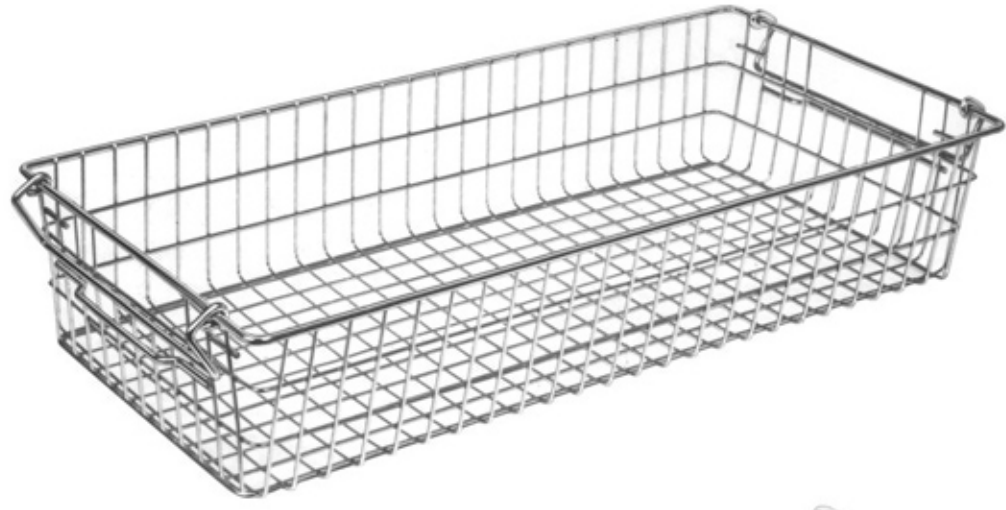

19-219
(60 x 30 x 15 cm)
Nominal dimensions

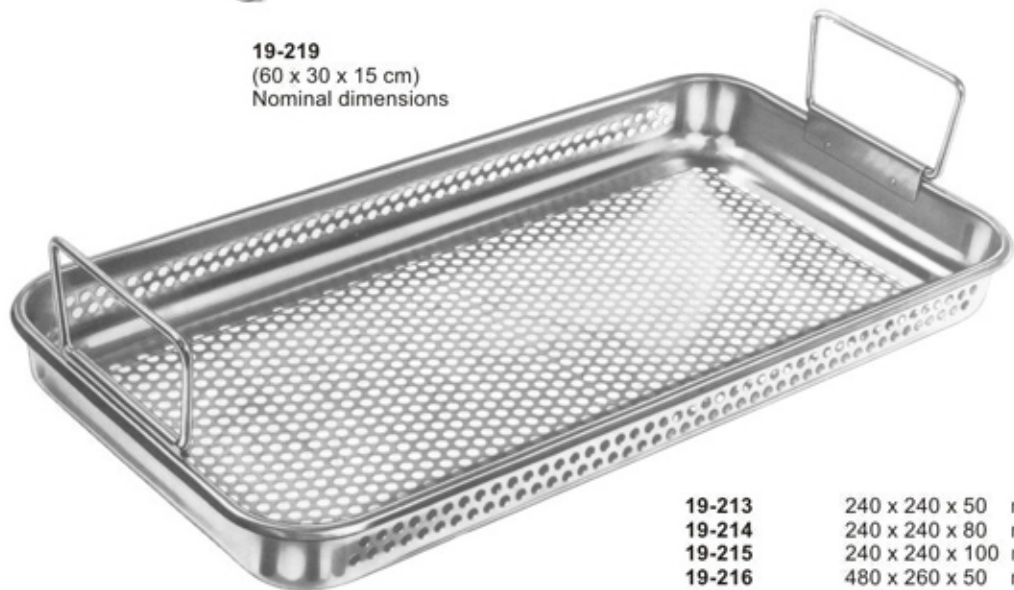

19-213 - 218

19-213	240 x 240 x 50	mm
19-214	240 x 240 x 80	mm
19-215	240 x 240 x 100	mm
19-216	480 x 260 x 50	mm
19-217	520 x 260 x 80	mm
19-218	520 x 260 x 100	mm

Scissors with Tungsten Carbide Inserts

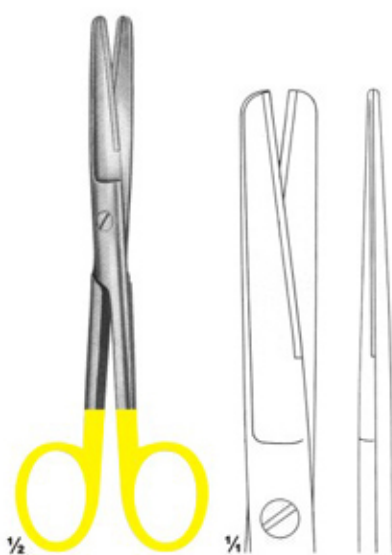

26-101
Standard

14,5cm
16,5cm
18,5cm

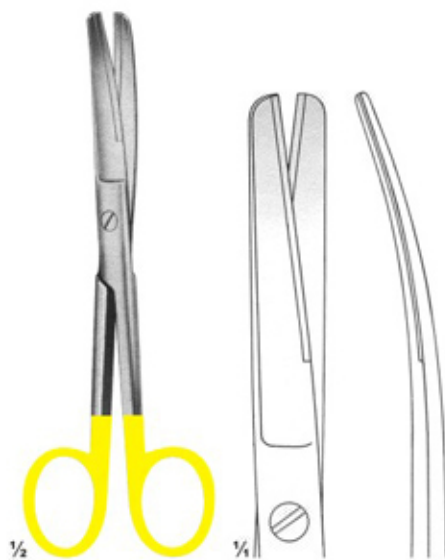

26-102
Standard

14,5cm
16,5cm
18,5cm

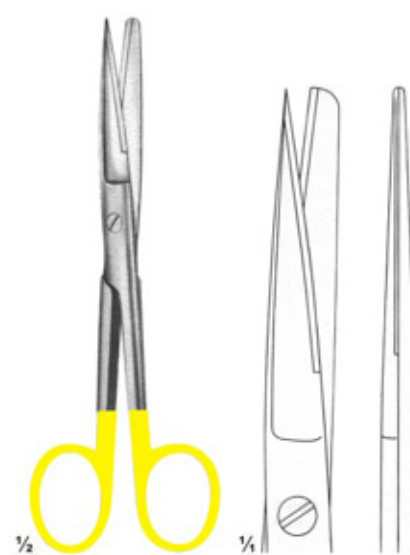

26-103
Standard

14,5cm
16,5cm
18,5cm

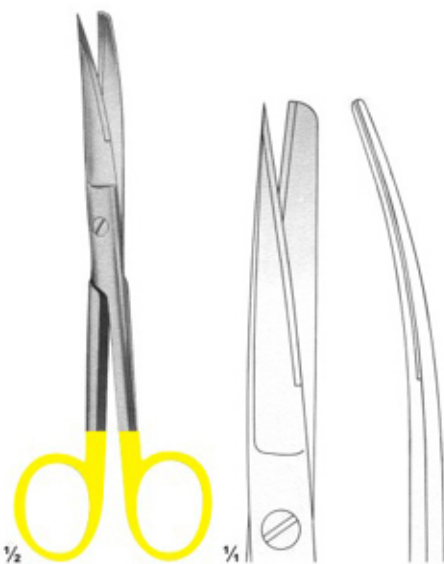

26-104
Standard

14,5cm
16,5cm
18,5cm



26-105
Standard

14,5cm
16,5cm
18,5cm



26-106
Standard

14,5cm
16,5cm
18,5cm

Scissors with Tungsten Carbide Inserts

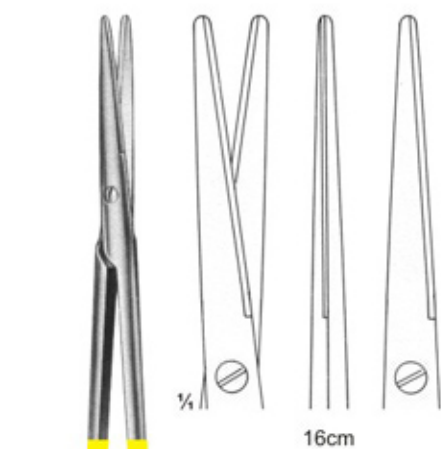

1/2
26-107
Mayo-Lexer

16cm

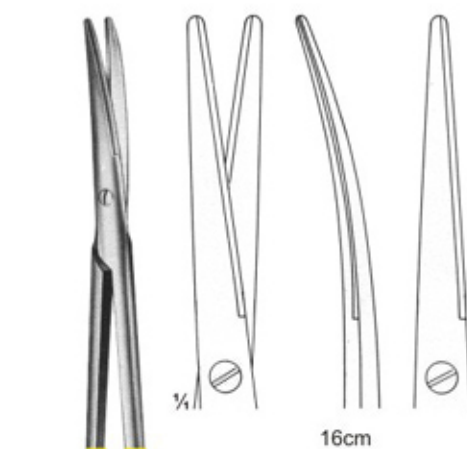

1/2
26-108
Mayo-Lexer

16cm

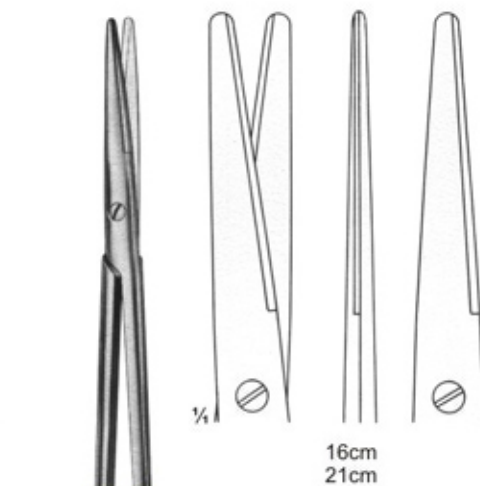

1/2
26-109
Lexer

16cm
21cm

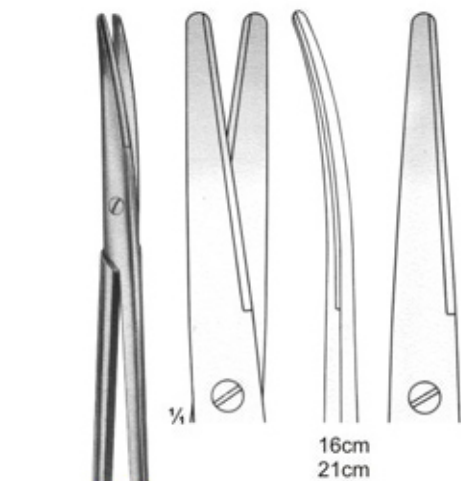

1/2
26-110
Lexer

16cm
21cm

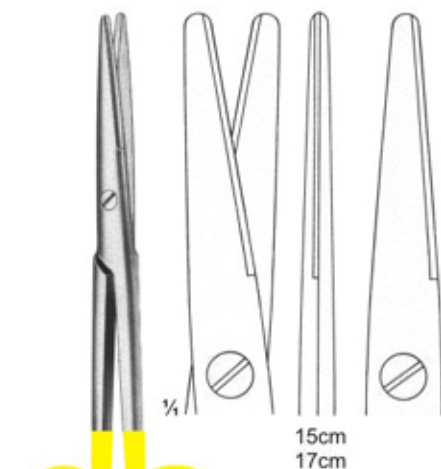

1/2
26-111
Mayo-Stille

15cm
17cm

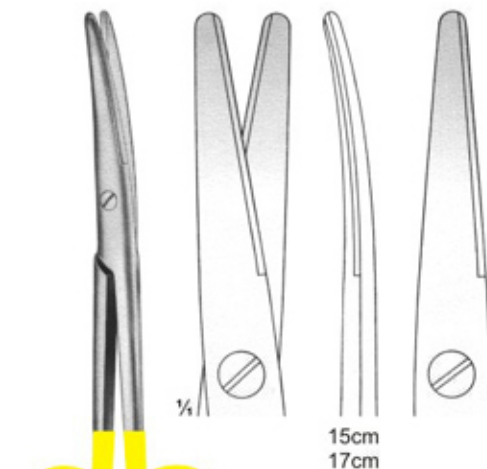

1/2
26-112
Mayo-Stille

15cm
17cm

Scissors with Tungsten Carbide Inserts



26-113
Metzenbaum

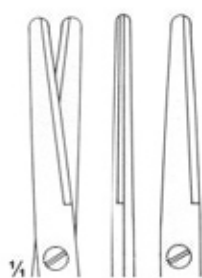

18cm
20cm
28cm
30cm

11,5cm
14,5cm
23,5cm
25,5cm



26-114
Metzenbaum



11,5cm
23cm

14,5cm
25cm

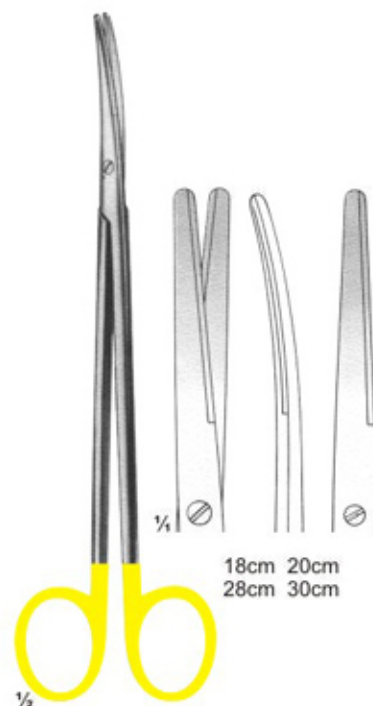

26-115
Metzenbaum



18cm
28cm

20cm
30cm

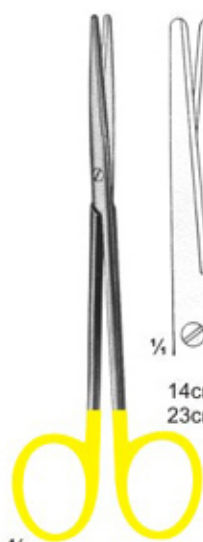

26-116
Metzenbaum-Fino

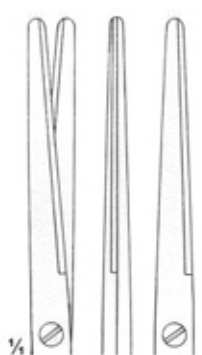

14cm
23cm

18cm
25cm

20cm
28cm

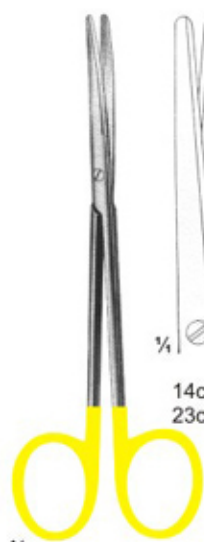

26-117
Metzenbaum-Fino

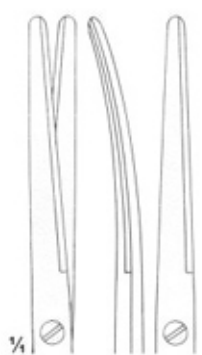

14cm
23cm

18cm
25cm

20cm
28cm



26-118
Metzenbaum-Fino



14cm
20cm

18cm
23cm

Scissors with Tungsten Carbide Inserts

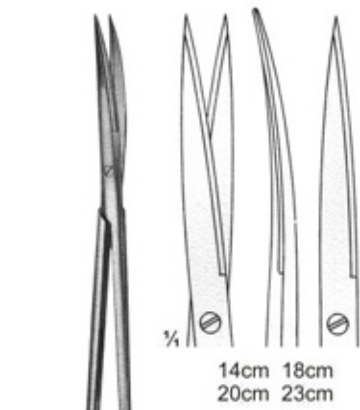

1/2
26-119
Metzenbaum-Fino

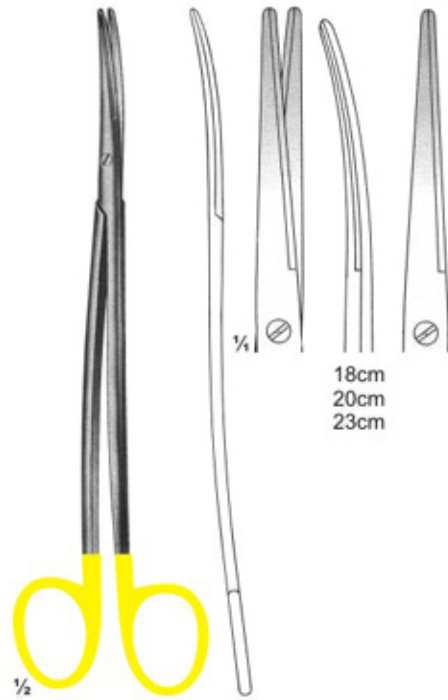

1/2
26-120
Metzenbaum-Fino

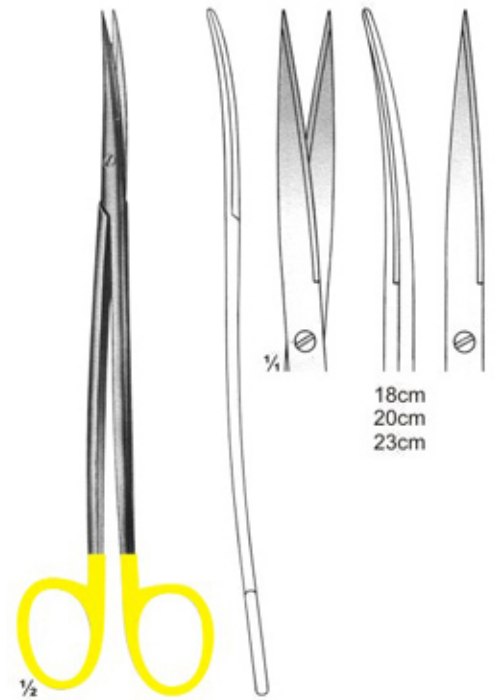

1/2
26-121
Metzenbaum-Fino

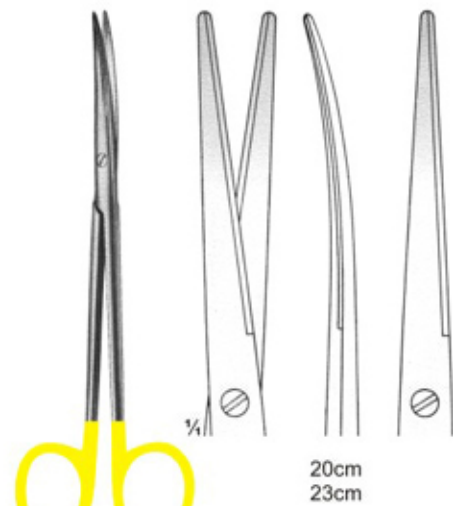

1/2
26-122
Metzenbaum

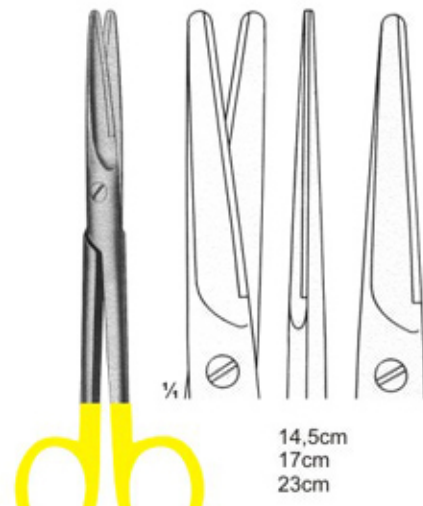

1/2
26-123
Mayo

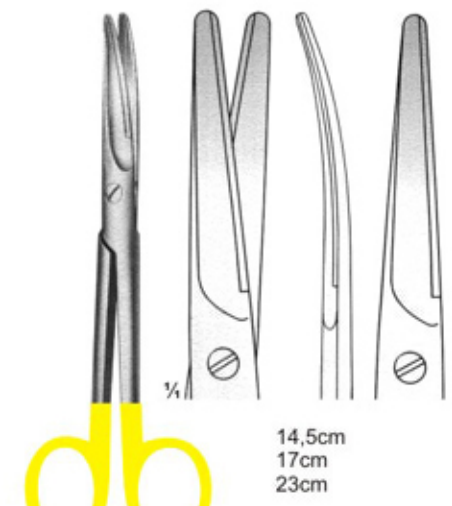

1/2
26-124
Mayo

Scissors with Tungsten Carbide Inserts

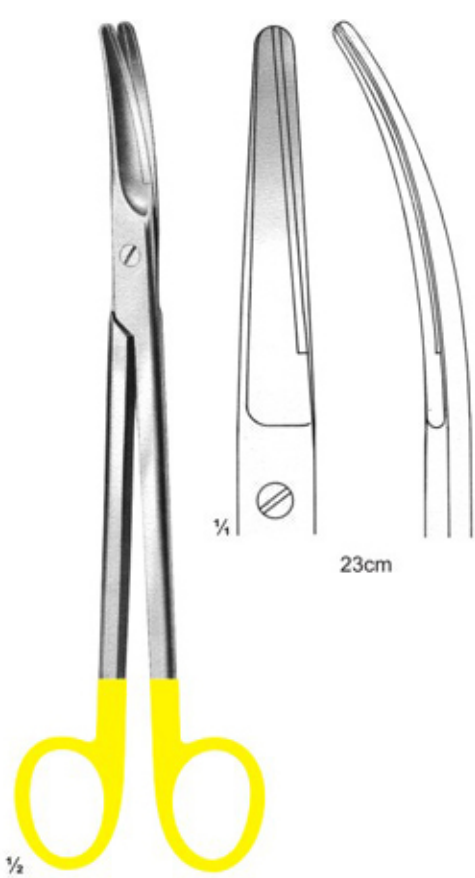

26-125
Parametrium

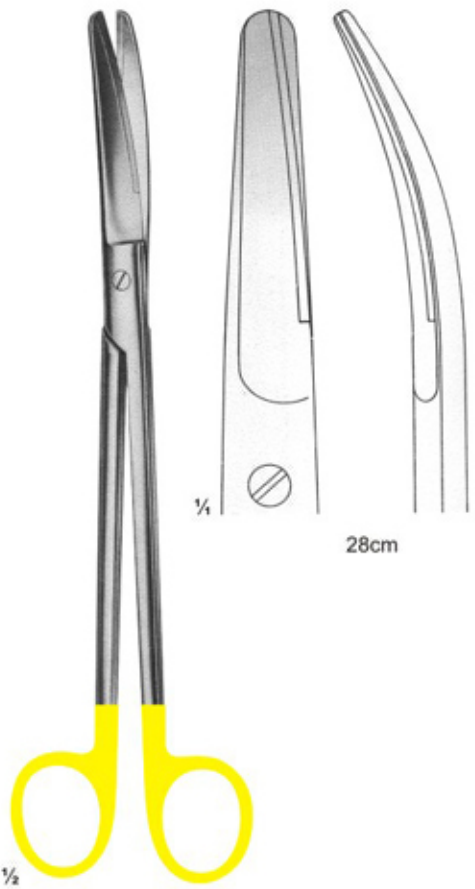

26-126
Mayo-Harrington

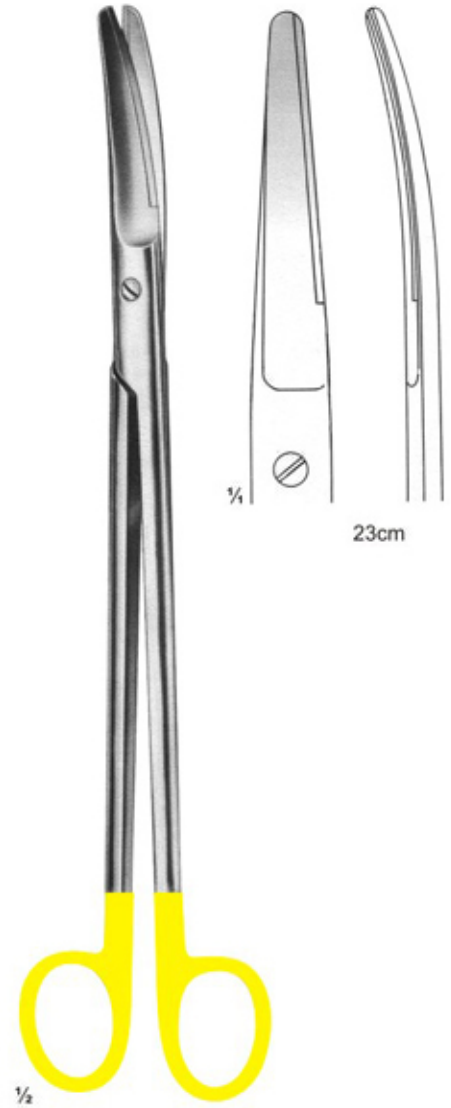

26-127
Sims

Scissors with Tungsten Carbide Inserts

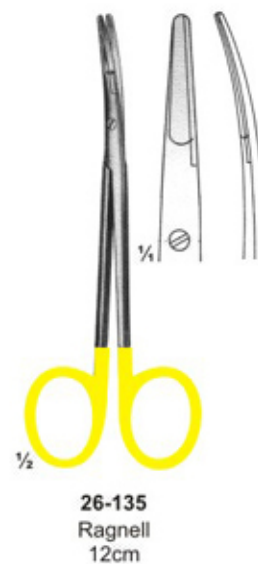
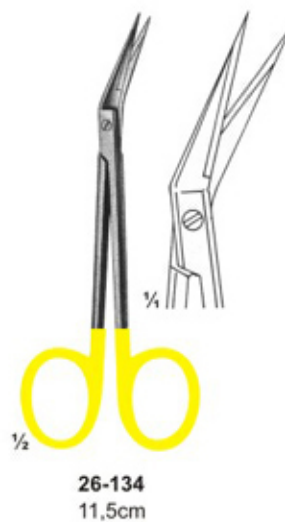
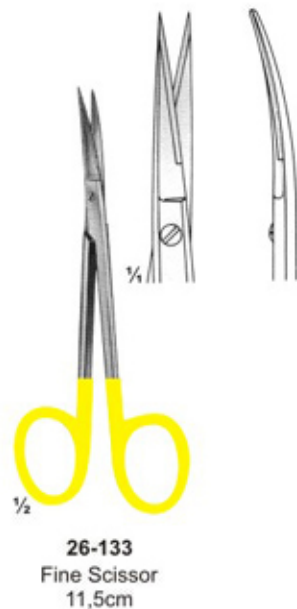
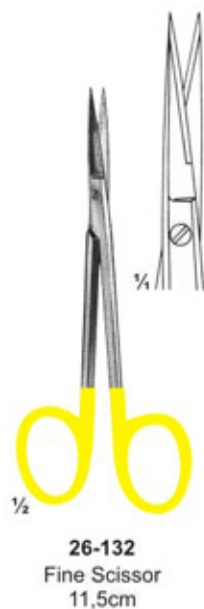
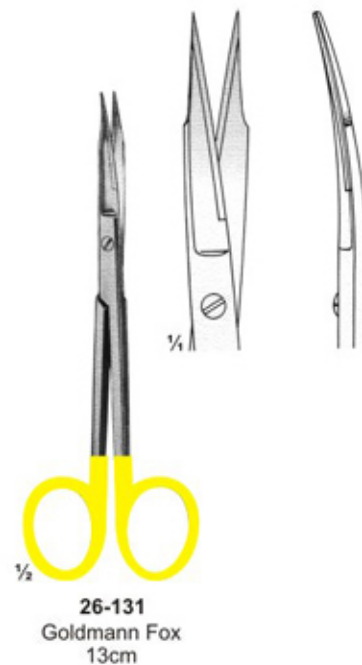
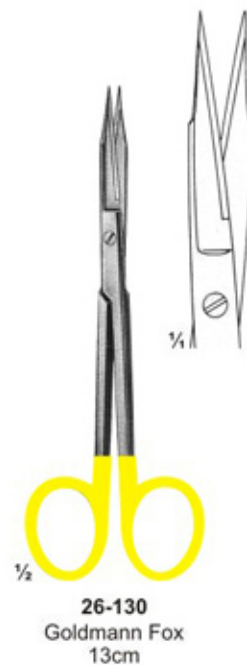
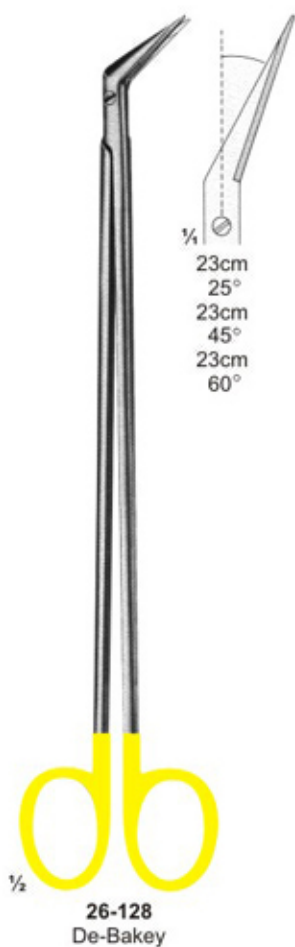

Scissors & Dissecting Forceps with Tungsten Carbide Inserts

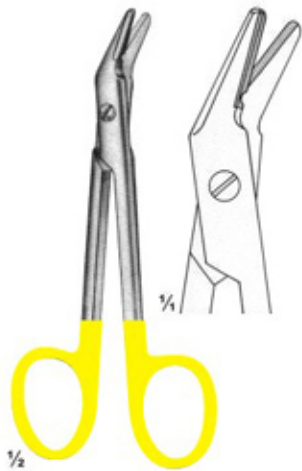

26-136
Universal
12cm

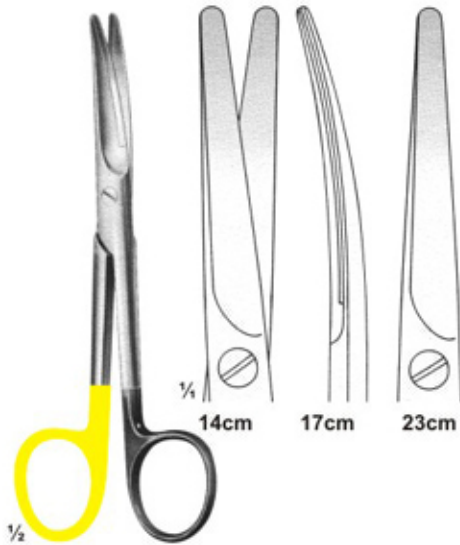

26-137
Ligature Scissors
1 Black & 1 Goldplated ring

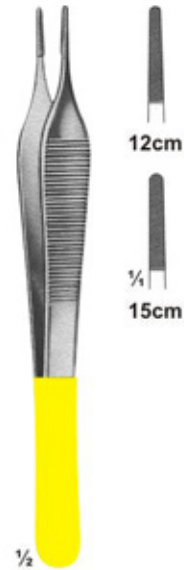

26-138
Adson



26-139
Cushing
17,5cm



26-140
Cushing
18cm



26-141
Cushing-Taylor
18cm



26-142
Dissecting Forceps
15cm



26-143
Semken
15cm

Dissecting Forceps and Needle holders with



26-144
Wangensteen

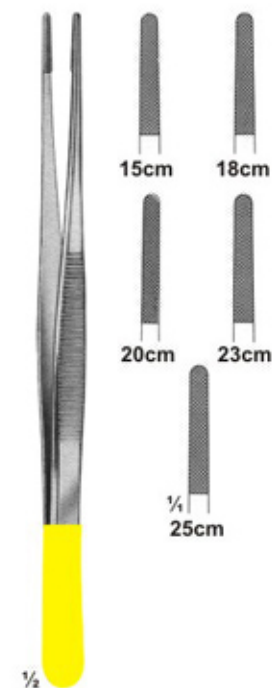

26-145
Potts-Smith

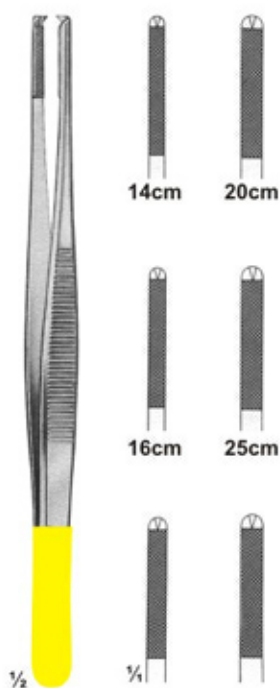

26-146
Oehler



26-147
Potts-Smith
22cm



26-148
Hepp-Scheidle
18cm



26-149
Castroviejo
14cm



26-150
Castroviejo
14cm



26-151
Arruga
16cm

Needle holders with Tungsten Carbide Inserts



26-152
Arruga
16cm



26-153
Castroviejo
13cm

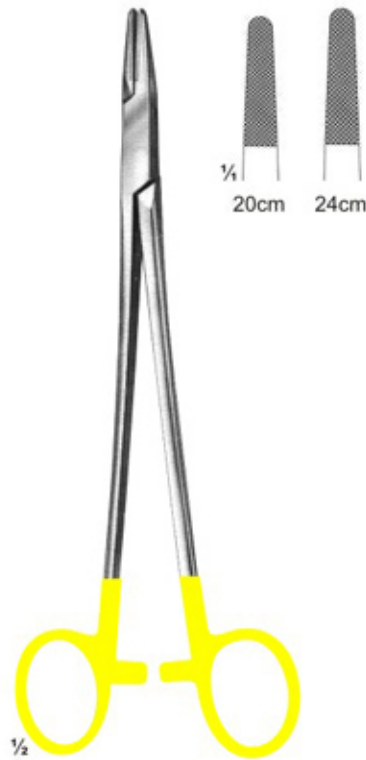

26-154
Hegar
20cm 24cm

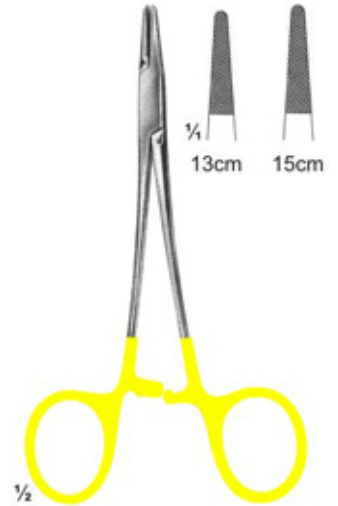

26-155
Halsey
13cm 15cm



26-156
Mayo-Hegar
16cm 18cm 20cm
24cm 26cm 30cm

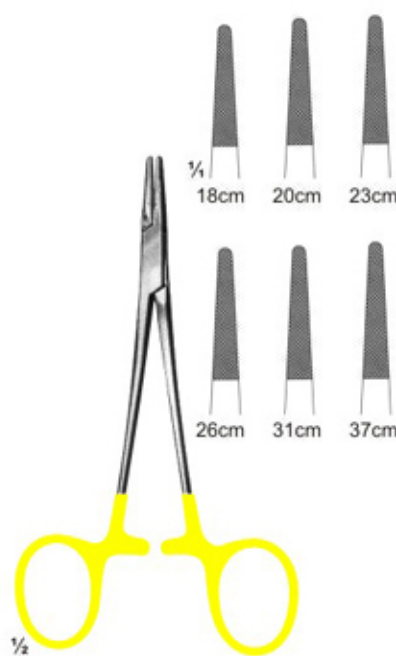

26-157
De-Bakey
18cm 20cm 23cm
26cm 31cm 37cm

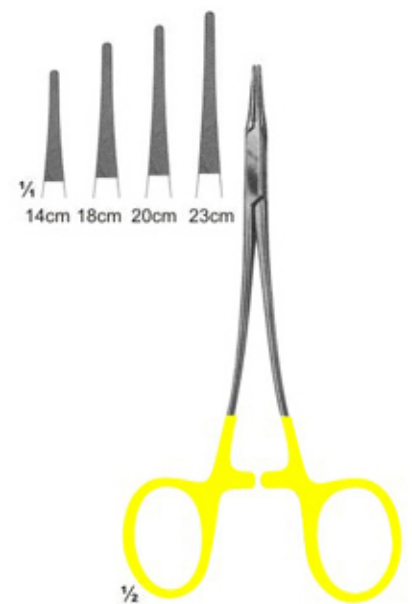

26-158
Hegar-Vascular
14cm 18cm
20cm 23cm

Needle holders with Tungsten Carbide Inserts

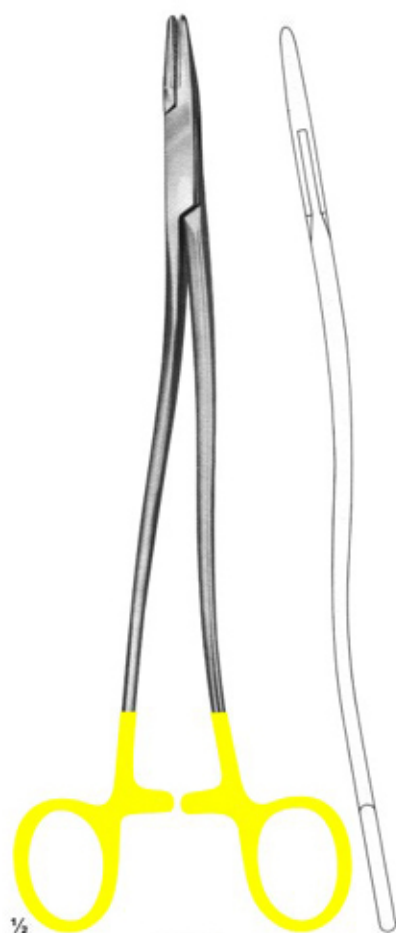

26-159
Bozemann-Wertheim
20cm 24cm 26cm

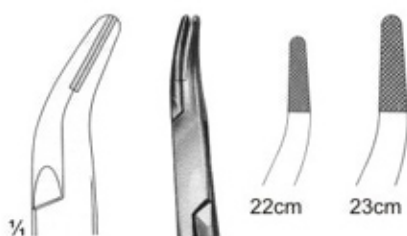

26-160
Stratte
22cm 23cm

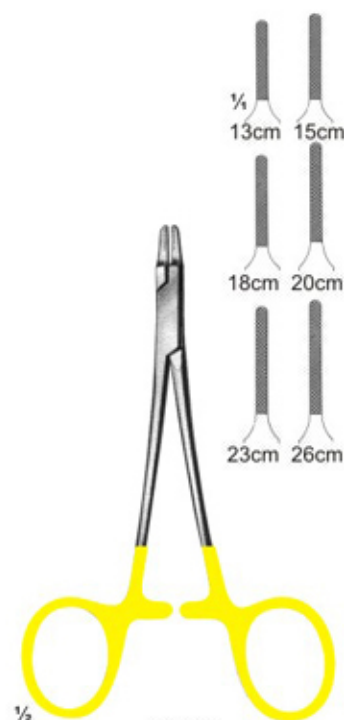

26-161
Ryder
13cm 15cm 18cm
20cm 23cm 26cm



26-162
Ryder-Vascular
13cm 15cm 18cm
20cm 23cm 26cm



26-163
Martin
15cm 17cm 20cm



26-164
Sarot
18cm 20cm 26cm

Needle holders with Tungsten Carbide Inserts

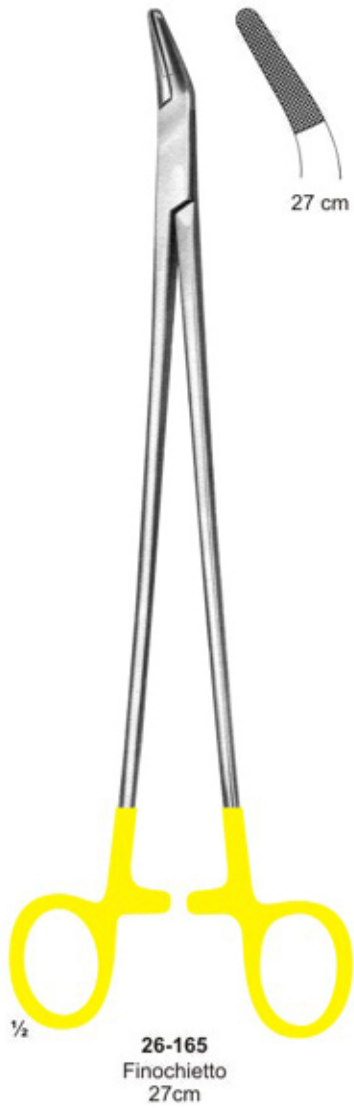

Needle holders with Tungsten Carbide Inserts



26-172
Mathieu-Ryder
17cm
20cm 24cm



26-173
Lichtenberg
20cm



26-174
Langhals
20cm 25cm



26-175
Lichtenberg
20cm 25cm



26-176
Luehty-Beck
20cm 25cm



26-177
Luehty-Beck
20cm 25cm



26-178
Langebeck
18cm
20cm 23cm



26-179
Langebeck-beck
18cm
20cm 23cm

Wire Cutting Plier With T.C. Inserts



26-180
TOENNIS
 Elastic pattern for
 dura-or intestinal suture
 180 mm



26-181
 Cutting Plier
 12 cm

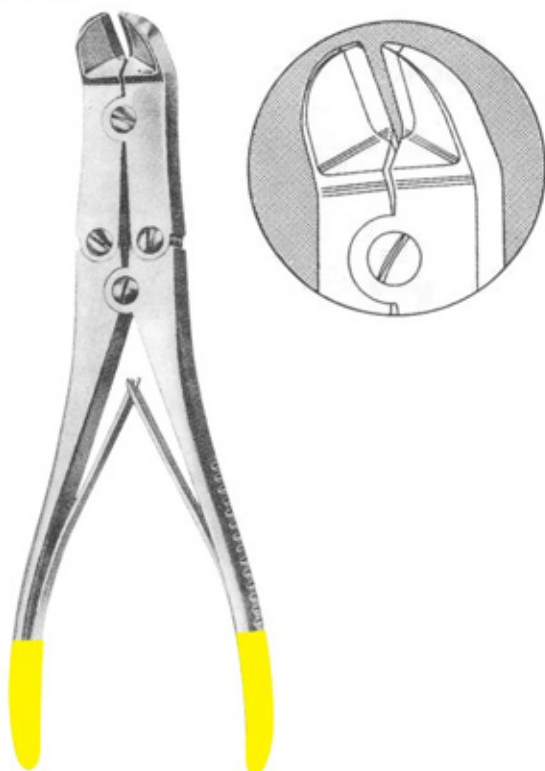

26-182
MULLAR CLAUS
 22 cm



26-183
 Plier
 17.5 cm



Micro Metal
Corporation

Maulana Hali Road, S.I.E. Sialkot, 51310 Pakistan.

+92-52-3252270

info@micrometalcorp.com / micrometalcorp@gmail.com

www.micrometalcorp.com